

The University of Adelaide

Romaldo Giurgola in Australia and the ‘Other’ Modern Tradition

Stephen G. Schrapel



Aldo Giurgola, 2005 by Mandy Martin. Ochre, pigment and oil on linen. Collection: National Portrait Gallery, Canberra. Commissioned in recognition of Giurgola’s life-long contribution to architecture and funded by voluntary donations from members and friends of the architectural profession. Gift of the Royal Australian Institute of Architects 2005.

A thesis submitted to the University of Adelaide in fulfilment of the requirements for the
degree of Doctor of Philosophy

August 2015

Contents

Abstract.....	v
Declaration.....	vii
Acknowledgements.....	ix
Chapter 1 Introduction	11
Romaldo Giurgola: A brief portrait	15
Overview of post-Parliament House (1983) works.....	18
Structure.....	26
Chapter 2 Situating Giurgola	29
Introduction.....	29
An overview of the critical review of Mitchell/Giurgola (1958—2010).....	30
Mitchell/Giurgola and the architectural culture of the late 1950s to 1970s in North America: ‘The Philadelphia School’ and a ‘Third Generation’	30
‘Grays’ and ‘Whites’	36
Australia.....	45
Giurgola’s writing (1962–2010)	49
1960s–1980s	49
Australia: 1980s–2000s.....	54
Some Common Themes	55
Contextual modernism.....	55
Learning from Alvar Aalto and the ‘Nordic style’	62
Working methods.....	66
Discussion.....	68
Chapter 3 Method	71
Introduction.....	71
Historical-Interpretative Process.....	74
Participant Observation.....	74
Conversations and interviews	77
Formal Analysis	80
Case Study Selection.....	86

Discussion.....	87
Chapter 4 New Parliament House (1979-1988).....	89
Critical reception of the New Parliament House: An overview	95
Mitchell/Giurgola in the 1970s: Italian and Swedish connexions	100
The 1980s American Scene	113
Australian anticipation.....	116
Other Possible Parliaments	117
‘Fitting in’: Some observations on Parliament House from a distance	122
Postscript: After Parliament House.....	130
Chapter 5 Downsizing: St Thomas Aquinas Church, Canberra (1986–91).....	133
Introduction.....	133
The most expensive architect in Australia.....	139
Concluded, or even <i>démodé</i>	141
The design of St Thomas	143
Analysis.....	153
Interior	156
Artists and artisans.....	160
Ruination/incompletion	161
Chapter 6 St Patrick’s Cathedral, Parramatta (1997–2003).....	167
Introduction.....	167
‘Genius’ architect.....	170
‘St Bunnings’	173
Some common themes	178
Formal Analysis.....	180
The site.....	180
The building.....	184
Suspended screen wall	190
Artists and artisans.....	197
The quiet subversion of St Patricks	199

Chapter 7 RG House, Lake Bathurst, New South Wales (2002-2003).....	203
Critical review.....	205
A country house.....	207
Discussion.....	217
Postscript to the RG House: The villa as paradigm and the architecture of the 1980s Australian country house	220
Chapter 8 Conclusions	227
References.....	235
Appendices.....	243

Abstract

This research thesis examines the mature work of the architect Romaldo Giurgola in Australia. Born in 1920 in Rome, Italy, Giurgola is best known in Australia for the design of the New Parliament House, a significant contribution to Australian architecture. Yet his work beyond the parliament building has received scant attention. It is little recognised that after his decision to reside permanently in Canberra, and later becoming an Australian citizen in 2000, Giurgola designed several buildings in Australia, and two international commissions from his Canberra base.

Colin St John Wilson describes an ‘Other Tradition of Modern Architecture’ (1995) in which, rather than being an isolated movement in architectural history, he positions Modernism as an ‘uncompleted project’, one that continually emphasizes a response to specific physical and social contexts rather than the expression of abstract theories. Examining four of Giurgola’s Australian buildings, this thesis casts Giurgola’s Australian work in St John Wilson’s ‘other tradition’ of modernism. Giurgola’s geographic and intellectual traverse provides a unique journey through post-war architectural theory and practice from his architectural education in the Beaux-Arts tradition to the upheaval on the East Coast of the United States in the 1960s to the diffusion of post-modernism in Australia. His response to the specific architectural task is a continual negotiation between a set of contextual concerns, technology and his idiosyncratic concepts of ‘home’ and ‘citizenship’. I argue that the formal tension Giurgola creates between elements in his architecture reflects the complexity of contexts in which he worked, and is what, although stylistically different, brings together the work of architects that may at first glance be quite dissimilar to Giurgola such as Australian architects Glenn Murcutt, Troppo Architects, Ashton Raggatt McDougall, and Richard Leplastrier. Further, I argue that Giurgola’s encounter with Australia was a transforming experience in which he found that the discontinuity and calculated incompleteness of Nordic modernism was a good fit for Australia.

The study provides new insight into the mature work of an architect who has contributed substantially to Australian architecture, and, through the parliament building, to Australia’s image of governance.

Declaration

I certify that this work contains no material which has been accepted for the award of any other degree or diploma in my name, in any university or other tertiary institution and, to the best of my knowledge and belief, contains no material previously published or written by another person, except where due reference has been made in the text. In addition, I certify that no part of this work will, in the future, be used in a submission in my name, for any other degree or diploma in any university or other tertiary institution without the prior approval of the University of Adelaide and where applicable, any partner institution responsible for the joint-award of this degree.

I give consent to this copy of my thesis, when deposited in the University Library, being made available for loan and photocopying, subject to the provisions of the Copyright Act 1968.

I also give permission for the digital version of my thesis to be made available on the web, via the University's digital research repository, the Library Search and also through web search engines, unless permission has been granted by the University to restrict access for a period of time.

Signed:Stephen G L Schrapel

Date:

Acknowledgements

I am indebted to my supervisors, Antony Radford and Peter Scriver, for their perseverance and encouragement in this research project, particularly for their endurance.

I wish to thank Aldo Giurgola for his participation and enthusiastic support, as well as being an inspiration to me as an architect and person. I also acknowledge the valuable contributions of former employees and associates of Mitchell/Giurgola and Thorp who have participated in this study, and for their constructive feedback on draft text: Hal Guida, Rollin La France, Pam Berg and Robert Thorne. Also I thank former clients of Mitchell/Giurgola Architects (and Mitchell/Giurgola and Thorp Architects) for their time to be interviewed: Pehr Gyllenhammar, Bishop Kevin M. Manning and Father Peter Williams. In particular I thank Hal Guida who took considerable time reviewing the thesis.

I acknowledge the assistance of Architectural Archives of the University of Pennsylvania for access to their archive and permission to re-produce images from the Mitchell/Giurgola archive, particularly to William Whitaker and Nancy Thorne. Thank you also to Christian Unverzagt at the University of Michigan for bringing forward the scanning of early issues of Dimension magazine.

I acknowledge the work of professional editor Miranda Roccisano who provided assistance with Chapters 1, 2, 4 and 8. Her work was undertaken in accordance with the University of Adelaide policy for editing.

Special thanks to my wife Dora and our children Antonio, Emilio and Isabel for their encouragement, and for the time they have sacrificed with me. I sincerely thank my parents who have supported me and my family in this journey.

Chapter 1 Introduction

Until the announcement of the winning Mitchell/Giurgola and Thorp competition entry for the Federal Parliament in June 1980, Romaldo Giurgola, the lead designer of the firm, was relatively unknown in Australia and knew little of the country.¹ Over the intervening eight years until the completion of Parliament House in 1988, a transformation took place in the nation's capital. A new parliament building was installed and Giurgola became a well-known Australian figure, ultimately choosing to settle to Australia; specifically Canberra. It is little recognised, however, that apart from Parliament House Giurgola went on to complete no fewer than six buildings of note in Australia, and two international commissions from Canberra.

This thesis was motivated by my employment in the office of Mitchell/Giurgola and Thorp Architects during which time I worked directly with Romaldo Giurgola. My expectations upon entering the office were largely informed by Parliament House and the characterisation of Giurgola as an acolyte of the better-known Louis Kahn. The majority of the existing critical literature that surrounded Parliament House considered the building to be a result of a coincidental trajectory of Giurgola from East Coast American scene and the arrival of the post-modern in Australia via repatriated Australian architects who had left to undertake studies in the United States. Yet there were noticeably other concerns at play. While working with Giurgola, his frequent reference in our discussions to the work of Alvar Aalto and other Scandinavian architects, such as Gunnar Asplund and Jørn Utzon, was unexpected. The influence can be observed in his design for buildings during the 1970s leading up to his re-settlement in Australia, and has been noted by others; however, the emphasis Giurgola placed on a Nordic flavour of modernism is seemingly at odds with the flowering of post-modernism in Australia during the 1980s and 1990s.

¹ Giurgola unsuccessfully participated in a competition for a memorial to Walter Burley Griffin in 1975, but had never visited Australia prior to the second round of the Parliament House competition.

This study analyses four of Giurgola's Australian works in greater detail to understand more about this important architect and his work in Australia. Through a closer look at his Australian body of work, I attempt to understand why Alvar Aalto, amongst other Nordic designers, remained a compelling figure for Giurgola. Further, if it can be said that Giurgola's encounter with Australia prompted recollections of visits to Northern Europe in his youth, what is it about a Nordic tradition of modernism that the mature Giurgola – as an outsider – found a good fit for Australia? The study looks to answer questions such as: how did he view Australia? And, how did his move from New York to peripheral Canberra move his centre of vision? I argue that Giurgola's personal history and migration across three continents, 'leaving, arriving and arriving again'²: from Italy to post-war America and his coincident encounter with Australia and Sweden through a commission there for Volvo in the 1980s was the prism that skewed Giurgola's trajectory. Likewise, the lens of the Australian buildings has the potential to provide a new interpretation of the Parliament House, a building that has become tied to the Australian people's image of how they are governed, and as a measure of the extent to which our reading of Australian architecture has shifted following its completion.

Colin St John Wilson³ describes an 'other tradition of modern architecture' in his book for the same title (1995) in which he positions Modernism as an 'uncompleted project', rather than an isolated movement in architectural history'. St John Wilson claims that the modernism exemplified by architects such as Hugo Haering, Hans Scharoun, Alvar Aalto and Frank Lloyd Wright was overshadowed by abstract concepts, led by Le Corbusier, fracturing the relationship between building and site. St John Wilson claims that the development of modernism was overshadowed by abstract theories and concepts, steered by Le Corbusier and the role of the CIAM, that

² Title of the September group of talks with the subject, Romaldo Giurgola in the series of Tuesday night talks held by the NSW chapter of the RAIA, 2006.

³ St John Wilson coincidentally was a friend of Giurgola's, their friendship sparked during St John Wilson's teaching appointments at Yale (Giurgola 2010). St John Wilson's architecture, particularly the British Library, is indebted to Alvar Aalto who was St John Wilson's mentor in many respects.

led to an inflexible set of tropes (the ‘five points’) and adoption of a modern style that fractured the relationship between building, site and desires. Instead, St John Wilson describes his vision of modern architecture as a ‘practical art’ which supports the creation of environments we might like to inhabit. In St John Wilson’s words, ‘the building viewed as an object (the beautiful object contemplated sub specie aeternitatis) and the building viewed as a framework for the actions of men, a place of enactment and celebration, a theatre that makes action possible...experienced existentially...’.

In speaking of the language of such an architecture, St John Wilson presents an order based on real experiences such as inside, outside or ‘in the in-between world of the threshold’. Citing the work of psychoanalyst Melanie Klein, the co-founder of Object-Relation Theory (later related to Attachment Theory), and the translation of its concepts to art and architecture by Adrian Stokes, St John Wilson similarly argues that the change from one ‘position’ (being outside – exposed and vulnerable, or being inside - sheltered) to the alternative ‘position’ is disorientating. St John Wilson goes on to claim that the architectural equivalent of being outside lies in the state of being in the open and confronted by the façade of a building. Hovering on the threshold of being inside and being outside is not only an aesthetic experience but produces an emotional response. In St John Wilson’s view, ‘Combinations of these spatial figures form a narrative that is the real art of architecture’ as opposed to ‘a refinement of an object and its ‘forms of light’’. It is St John Wilson’s view that the rhythm of architectural spaces should be composed to respond to activities that the building is intended to serve and the elements from which it is made respond to human presence; ‘the intimate language of inhabitation.’

The theoretical underpinnings of St John Wilson’s other tradition have been questioned on a number of grounds, in particular, St John’s Wilson’s use of the philosophical concepts of Wittgenstein, Heidegger and Kant, as well as architecture’s relationship to history – St John Wilson’s focus on the individual experience and desires can be seen to downplay the merits of collective aspiration (Roberts, 1996). Nevertheless, the lens of an other tradition of modern architecture, one that is

responsive to and critical of its context, rather than conceived from an abstract set of principles, has resonance with the concept of architecture that resists autocracy.

This thesis casts Giurgola in the ‘other tradition’ of modernism. Giurgola’s geographic and intellectual traverse provides a unique lens that offers glimpses of much of post-war architectural theory and practice. His response to the specific architectural task is a continual negotiation between a set of contextual concerns, technology and his idiosyncratic concepts of ‘home’ or ‘citizenship’. I argue that the tension Giurgola creates in the composition of elements in his architecture is what, although stylistically different, brings together in the same tradition architects that may at first glance be quite dissimilar to Giurgola such as Alvar Aalto and Australian architects Glenn Murcutt, Troppo Architects, Ashton Raggatt McDougall, and Richard Leplastrier. The second outcome to which I return in the concluding chapter, is the possibility that the principles of the other tradition of modernism overlap with the prospect for an ethics of architecture described by the philosopher and ethicist Warwick Fox, particularly Fox’s concept of ‘responsive cohesion’ (Fox, 2006).

Romaldo Giurgola: A brief portrait



Figure 1.1 Fenelon, Neil (2011) *Romaldo Giurgola on the lawns of Parliament House, Canberra National Library Australia.*

Romaldo Giurgola was born in Rome, Italy, 2 September 1920. Giurgola credits his father who was, ‘an old-fashioned type of architect, the Beaux-Arts architect’ (Giurgola 2007a) with his introduction to architecture and by the age of around 12, he was already working in an architect’s office (Giurgola 2007a), where he learnt to draw. Giurgola spent his school years at a lyceum for humanities in Rome. His passion for an architecture was further developed during those years. Giurgola (2007a) explains,

I was born in Rome and lived in Rome. For me to take a walk was where I really learned. With all the buildings that were there it became an open book of learning architecture. You can’t fail. That

is the beauty of Italy. There are a lot of things to look at, whatever the choice is: from Gothic, or Renaissance, or Romanesque. Especially Rome, Rome started from the Classic world. Taking trips with my father we always wanted to go to see the temples in Greece, and so on, and I learnt about architecture in that way.

Giurgola studied architecture at the Sapienza University of Rome in the Ecole de Beaux-arts tradition but his studies were interrupted by conscription into the Engineering Corps of the Italian Army during World War II, where he served alongside prominent Italian architects and engineers such as Pier Luigi Nervi (Giurgola 2007a). Giurgola visited Northern Europe in 1945 (Giurgola 2007a). He returned to studies and graduated from the University of Rome in 1949 and subsequently, as a Fulbright Scholar, received the Master of Science in Architecture from Columbia University in 1951. In the same year, following a short return to Italy, Giurgola was appointed Assistant Professor of Architecture at Cornell University and left his Italian birthplace to resettle in the United States. However between 1948 and 1953, he also maintained an architectural office in Rome (Cooperman, 2006).

In 1954, Giurgola was awarded the position of Assistant Professor of Architecture at the University of Pennsylvania joining the dynamic, young, modernist faculty assembled by Dean G. Holmes Perkins (Cooperman 2006). Giurgola was joined there one year later by Louis Kahn. Giurgola and Kahn were friends during Giurgola's tenure at the University of Pennsylvania, and following Kahn's death in 1974, Giurgola provided the first comprehensive assessment of Kahn's work with the publication of the book, *Louis I. Kahn*, with Jaimimi Mehta, in 1975 (Giurgola & Mehta, 1975).

In 1958 Giurgola formed an association with Ehrman B. Mitchell and Warren Cunningham who he met during his employment at the firm of Bellante & Clauss. Cunningham remained with the others less than two years, but one of the association's first commissions, the Wright Brothers' Memorial Visitors' Center at Kill Devil Hills, NC, soon attracted critical attention to the work of Mitchell.

In April 1961 the architectural critic Jan Rowen named Giurgola, Louis Kahn, Robert Venturi, George Qualls, Robert Geddes, and others, as 'The Philadelphia School'

(1961), a characterisation that has coloured much of the writing about Giurgola and his work in the North American polemic. On one side there were the exclusives, or neo-functionalists, as represented by the ‘New York Five’⁴; and on the other were the inclusives, or neo-realists, – those architects gathered around Louis Kahn, including Giurgola, who were concerned with social order, content, and place-making.

In 1966, Giurgola moved to New York City to become the Chair of the Department of Architecture at Columbia and to establish a second office of the firm. Giurgola stepped down as chairman of the department in 1971, and was named Ware Professor, a chair he held until he accepted emeritus status in 1991. In the autumn of 1977, Giurgola was architect-in-residence at the American Academy in Rome. He was named Thomas Jefferson Professor of Architecture at the University of Virginia, 1979 (Cooperman, 2006).

Mitchell/Giurgola, joined by the Australian Richard Thorp, won the competition for the Australian Parliament House in 1980 from a pool of 329 entries. The project brought Giurgola from his adopted home in the United States to Australia. This was Giurgola’s grand project. It consumed ten years of his career, and carried with it, like the Dhaka Parliament (1962–1974) for Giurgola’s colleague, Louis Kahn, 20 years earlier, the opportunity for Giurgola to express his ideals for a participatory democracy in the New World. Following the completion of Parliament House in 1988, and his election to stay in Australia around that time, Giurgola completed further commissions for public buildings in Australia, including the St Thomas Aquinas Church, Charnwood (1989) and the St Patrick’s Cathedral, Parramatta (2004). The latter building received the Sir Zelman Cowen Award for Public Buildings in 2004, awarded by the Royal Australian Institute of Architects (the highest award for a public building in Australia), also earlier awarded to Parliament House.

⁴ The “New York Five” refers to the architects Peter Eisenman, Michael Graves, Charles Gwathmey, John Hejduk and Richard Meier whose work was published in the book “Five Architects” of 1972 (Wittenborn 1972).

Giurgola is the recipient of many awards. Giurgola received the Arnold Brunner Award in Architecture from the National Institute of Arts & Letters in 1966. He joined the national American Institute of Architects (AIA) in 1964 and was named a member of the Academy of Fellows in 1975. Alongside Australian architect Glenn Murcutt, Giurgola is the only other architect to receive both the Gold Medal from the AIA (1982) and the Royal Australian Institute of Architects Gold Medal (1988).

Overview of post-Parliament House (1983) works

The Parliament House period, and beyond into the 1990s, was also an era of internal transition in the offices of Mitchell/Giurgola in the United States and Mitchell/Giurgola and Thorp in Australia. As the construction of the parliament building progressed, a natural generational changeover began inside the two firms. Giurgola, however, continued to contribute to the output of Mitchell/Giurgola in New York in the early 1980s up until his decision to reside permanently in Australia. In Australia during the 1990s, he steered the design of several projects attributed to Mitchell/Giurgola and Thorp Architects, who had offices in Canberra and Sydney. Despite the announcement of his retirement in 1999, around which time the firm reformed as MGT Architects, Giurgola continued to provide design direction to commissions as a consultant to the Canberra office. In 2002, MGT Architects was dissolved and replaced by Guida Moseley Brown (GMB Architects) in Canberra and Francis-Jones Morehen Thorp (FJMT Architects) in Sydney. In 2005, Giurgola registered a business as a sole practitioner, Romaldo Giurgola Architect.

The works depicted below are a selection of buildings to which Giurgola's contribution is recognised. It is not intended as an exhaustive catalogue of the firm's work during this period but to provide a visual overview of the type, feel, and breadth of Giurgola and the firms' production. In this thesis, a further selection of buildings is examined more closely. Giurgola's role in each of the selected buildings, and others, is explained in later chapters. It is acknowledged that many architects, designers, artists and artisans contributed to their production.

St Thomas Aquinas Church, Canberra (1986–1991)

St Thomas Aquinas Parish Church in Charnwood, shown in Figure 1.2, is located in the North of Canberra. It is designed to seat around 400 people and is associated with a local Catholic school.



Figure 1.2 St Thomas Aquinas Church from the South East. Photograph by Peter Ellis. CC BY-SA 3.0.

Singapore Armed Forces Training Institute (SAFTI) (1989–1995)

In 1989, Mitchell/Giurgola and Thorp Architects was selected as Principal Architect in association with DP Architects Pte (Singapore) for the master planning and design of a new tri-service military academy for Singapore's Ministry of Defence. The Institute, consisting of more than fifty buildings, is spread over a lush tropical site of 85 hectares. It comprises academic and educational facilities, residential components for both officers and NCOs and a full complement of sporting and recreational facilities.(Guida, Moseley, & Brown, 2014). (See Figure 1.4)



Figure 1.3 SAFTI, Singapore. Photograph © Woh Hup Construction. <http://www.wohhup.com/our-projects/safti-military-institute>

University of the Sunshine Coast Masterplan, Queensland (1994)

The campus of the University of the Sunshine Coast, comprising buildings to house teaching, research, sports and healthcare, library and administrative and student services, is being developed on a site of 100 hectares at Sippy Downs adjacent to the Mooloolah River National Park (Guida et al., 2014).

Faculty of the Built Environment, School of Mathematics and the International Centre: Red Centre, University of New South Wales (1996)

The Faculty of the Built Environment building is one of the most recognisable on the UNSW campus and incorporates a range of facilities including lecture theatre, exhibition, classroom and seminar spaces, design studios, computer laboratories, student lounge, workplace environments and integrated public domain (Francis-Jones, Morehen, & Thorp, 2014). (See Figure 1.5)



Figure 1.4 'Red Centre' University of New South Wales. Photograph by John Gollings © FJMT Architects

*North Terrace Campus Lower Level Site Redevelopment –Adelaide University,
Adelaide (1996–2001), with Hardy Milazzo Architects*

Mitchell/Giurgola and Thorp won a 1996 national invited competition for the design of a project to redevelop the lower level of the University's North Terrace Campus. It included new buildings for Science and Engineering and Mathematical Sciences. (See Figures 1.6 and 1.7)

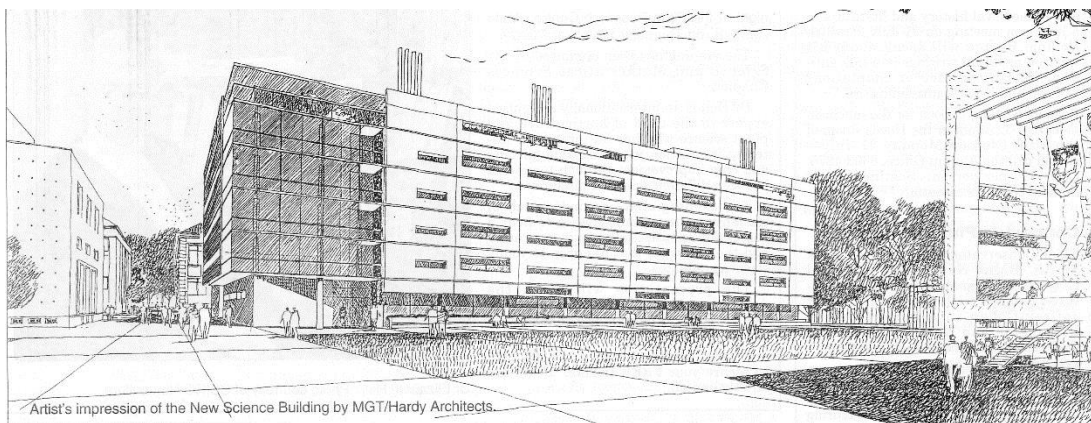

Figure 1.5 Competition design drawings of the Science Building (1997), University of Adelaide. Drawing by Romaldo Giurgola.



Figure 1.6 Science Building, University of Adelaide. Photograph by John Gollings. © Guida Moseley Brown Architects.

The Scientia, University of New South Wales (1999)

Mitchell/Giurgola and Thorp were engaged to design this landmark project following an invited design competition. According to FJMT Architects (formerly MGT Architects),

The Scientia is the symbolic heart of the campus and embodies the progressive spirit of the University. It was conceptually developed as a gravitational centre, a place of spontaneous gathering and a ceremonial focus for the university and wider community, and rapidly became the symbol of UNSW (Francis-Jones et al., 2014).

The building is a multi-purpose venue comprising a sequence of public and performance spaces, including a flexible flat-floor ceremonial hall, exhibition space, theatre and cinema, multi-function venue space, a music auditorium, foyer and bar, and four seminar rooms. (See Figures 1.8 and 1.9)

Its design is more widely attributed to the authorship of architect Richard Francis-Jones, though publications acknowledge Giurgola's contribution. The building was awarded the Sir Zelman Cowen Award in 2000.

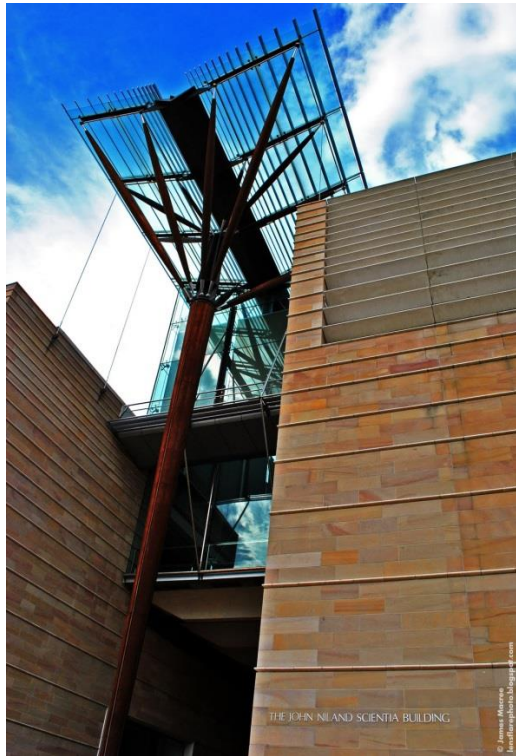

Figure 1.7 John Niland Scientia Building.
Photograph by James MacCree.
http://4.bp.blogspot.com/_bbVuPJURne4/TII2qFg82bI/AAAAAAAAAXk/E43vE8ZujNw/s1600/The+John+Niland+Scientia+Building.jpg



Figure 1.8 Scientia interior. Source: UNSW
<https://www.venuesandevents.unsw.edu.au/venues/scientia/leighton-hall.html>

St Patrick's Cathedral, Parramatta (1997–2003)

In 1997, a year after the substantial destruction of the pre-existing St Patrick's Cathedral by fire, MGT Architects were commissioned to restore and redesign the cathedral. The design team resolved to restore the ruined building as an entrance and chapel, and adjacent build a new cathedral space to accommodate a greater number of people in an arrangement better suited to a modern liturgy. (See Figures 1.10 and 1.11)



Figure 1.9 St Patrick's Cathedral from courtyard. Photograph by author.



Figure 1.10 St Patrick's interior. Photograph by author.

RG House, Lake Bathurst, New South Wales (2002-2003).

About 1999 Giurgola purchased 40 hectares of land near the rural township of Lake Bathurst in New South Wales with a view to building a retirement weekender, the first house he would design for himself. The house was completed in 2003.

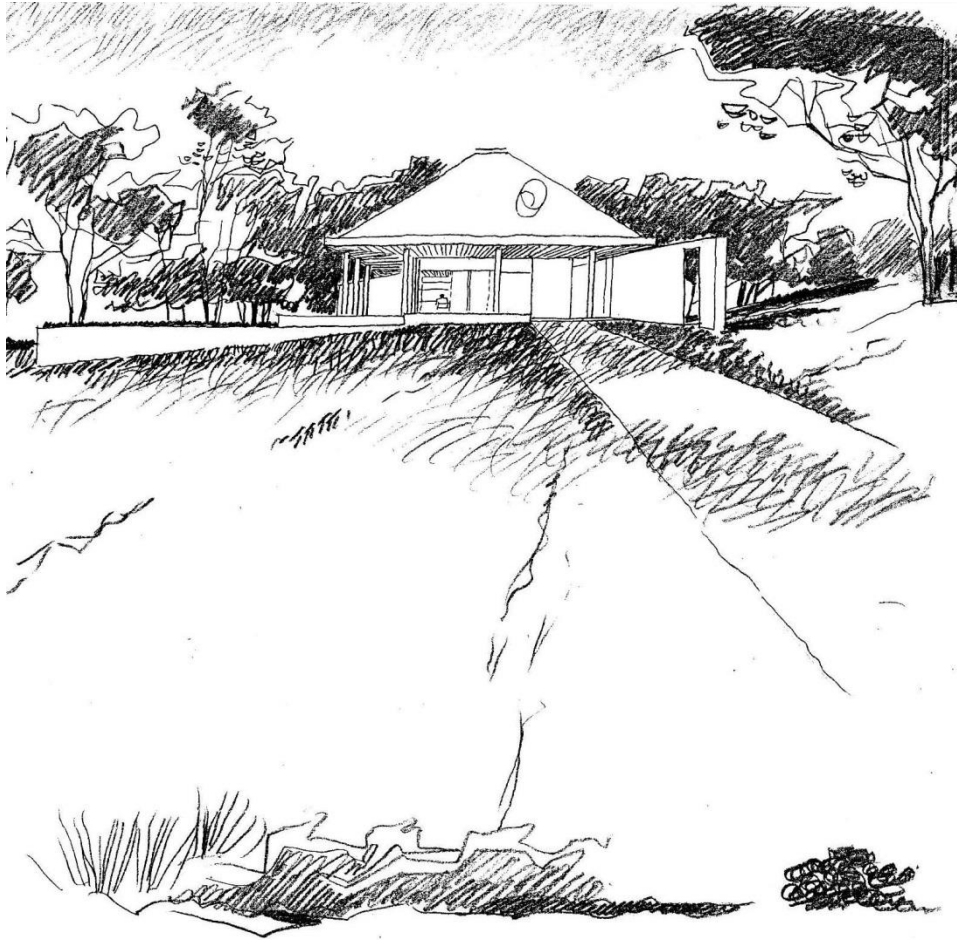

Figure 1.11 Sketch of Giurgola's Lake Bathurst house from below (post construction). Drawing by Romaldo Giurgola, 2004.

York Park Oak Plantation Restoration (2007-2011) - in collaboration with Pamille Berg Consulting and Redbox Design Group⁵

In 1927, whilst in Canberra for the opening of Parliament House, the then Duke of York planted a symbolic English Oak. In 1931, to provide relief work for the unemployed during the Great Depression, the Commonwealth Government made available funding to plant additional trees. 78 English Oaks were planted on a 12 metre grid, covering an area of 1.7 hectares.

⁵ Redbox Design Group are landscape architects. Its former directors, Peter Britz and Mervyn Dorrrough, are attributed with input to the York Park project. They are long standing collaborators of Giurgola, including holding senior design positions for New Parliament House.

In 2004 the oak plantation was listed on the Commonwealth Heritage register. Giurgola was invited to design a master plan for the park, which opened in 2011. An oak is planted in the park to commemorate Giurgola's 90th birthday, 2 September 2010. (See Figures 1.13 and 1.14)

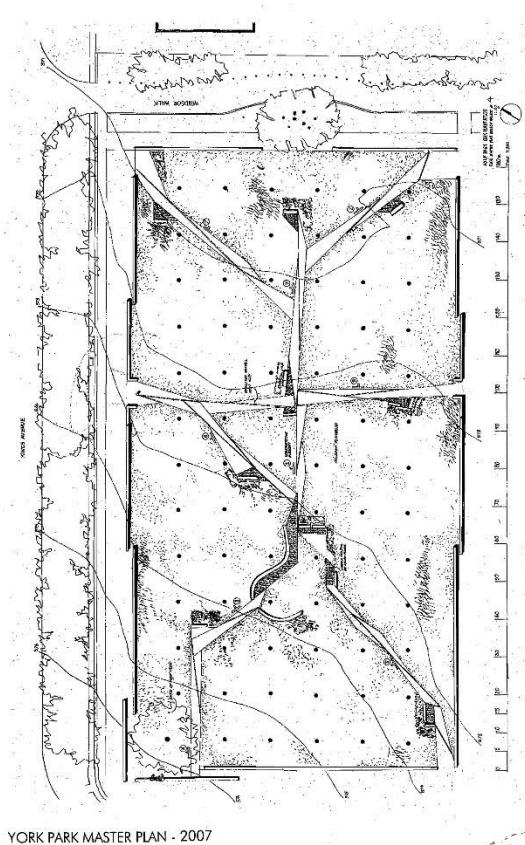

Figure 1.12: York Park Master Plan. Drawn by Romaldo Giurgola, 2007



Figure 1.13: York Park, Canberra. Photograph by Brett Bordman, 2007. Used with permission. © Romaldo Giurgola Architect

Structure

This study has four parts. It begins by examining and reflecting on the critical reception of Giurgola's architecture and his own writing. The review re-traces Giurgola's journey through the complexities of the late 1950s to 1970s in North America until his departure for Australia and looks to the importance of Nordic modernisms borne not only by Giurgola, but by the prominent architects of this period with whom he was associated, such as the influential Robert Venturi. The period also overlaps with Giurgola's tenure as Professor of Architecture at the University of Pennsylvania, coinciding with the pre-eminence of a group of architects that

surrounded Louis Kahn. Kahn was influential in the East Coast architectural scene during this period and Giurgola's close association with Kahn saw him aligned to the Kahn 'camp' – a group of architects who were reported to have a pluralist agenda centred on Kahn's ideas around community and the city. The review reflects on the appropriateness of Giurgola's membership of the Philadelphia School, the 'inclusives' and the post-modern.

The second part looks to the reception of Giurgola's work in Australia. The parliament building was a central positioning point for architectural discussion in the 1980s in Australia, but following its completion the critical comment on Giurgola's work dissipated. His later Australian buildings were noted in the mainstream architectural media but generally received little serious attention. The literature review will reflect on the possible reasons for the extent of consideration Giurgola received in Australian literature.

In the third part of the study I discuss several lenses proposed as a means to analyse Giurgola's Australian architecture. I discuss a case study method with a formal analysis as its foundation. I also explore the role of the diagram in formal analysis and how it can help to draw out knowledge from the work itself that might otherwise be unseen. A focus of these chapters is the notions of 'incompletion', a theme in studies of Alvar Aalto's architecture. I discuss the limitations of this method as well as the intertwining of the analysis with other sources, such as the interviews with Giurgola.

The following four chapters each take one of the Australian works introduced briefly above as the focus of more probing case studies: Parliament House; St Thomas Aquinas Church, Canberra; St Patrick's Cathedral; and the small get-away house he built for himself and his daughter at Lake Bathurst, New South Wales. The individual chapters generally follow the same structure, beginning with a review of the literature surrounding the individual building. This is interwoven with a narrative of Giurgola's personal journey extracted from his own writing and interview material. To provide a broader narrative frame through which to reflect on the building I review relevant material contemporary with the period. The central part of each chapter is an analysis of the subject building. To conclude each chapter, I compare the building with

Giurgola's other work and relevant work by others. My personal experiences as an employee of Mitchell/Giurgola Thorp Architects forms part of the view.

Each chapter emphasises different components. This is the natural result of the differing contexts of the various buildings, the passage of Giurgola's career, and the volume of critical interest. For example, Parliament House is better described in the critical literature, whereas the small church in Canberra has a suburban context and was given only scant review in the critical literature. Also, Parliament House, since it was conceived prior to Giurgola's arrival in Australia, is a building that bridges the two continents in his life narrative, and so a larger part of the Parliament House study is reflective, whereas the chapters dedicated to St Thomas Church and St Patrick's Cathedral provide a deeper analysis of their form and context within the Australian setting.

To conclude, a final chapter provides a summary of the forms of incompleteness highlighted in the case studies. I determine that Giurgola's architecture has affinities with the work of Fox, who has developed a single, integrated approach to ethics, particularly his 'theory of responsive cohesion' (Fox, 2006). Finally, I suggest some possible opportunities for future related research.

Chapter 2 Situating Giurgola

Introduction

By the time Giurgola arrived in Australia the Mitchell/Giurgola firm had a well established reputation on the East Coast of the United States, but although they were well-respected and internationally recognised throughout the second half of the Twentieth Century, they have a limited presence in art historical literature (Beier, 2006).

The first part of this literature review will look at Giurgola's relation to the central themes of the period from the inception of Mitchell/Giurgola Architects in 1958 until the end of the 1970s when Giurgola embarks upon the Australian Parliament House competition. The second part of this review will touch upon his post-USA period in Australia and his published buildings, however each later case study chapter will present more detail on the Australian literature.

The second part will look at Giurgola's own writing. In the USA and Australia Giurgola consistently wrote on architectural theory and provided criticism on the work of his contemporaries. It will look at his writing as evidence of the architect's own thoughts and the theories that he considered central to his design process, particularly his concepts of a 'partial vision' and architecture as a fragment.

The final part of this literature review will attempt to understand the field in which Giurgola produced his work by establishing common concerns amongst Giurgola's peers. It will do this by looking at common themes in the literature and making a broader comparison with his contemporaries. This part of the review will also further interrogate the moral responsibilities in creating human environments and the concepts of renovation vs. revolution of the modern project.

An overview of the critical review of Mitchell/Giurgola (1958—2010)

Mitchell/Giurgola and the architectural culture of the late 1950s to 1970s in North America: ‘The Philadelphia School’ and a ‘Third Generation’.



Figure 2.1 Visitors Center at the Wright Brothers Memorial. Photograph by RadioFan, 2008. CC BY-SA 3.0.

https://upload.wikimedia.org/wikipedia/commons/e/eb/Wright_Brothers_Memorial_visitors_center.JPG

The 1957 partnership of Ehrman B. Mitchell, Jr, a Pennsylvania native, and Romaldo Giurgola, the firm’s lead designer, was formed on the promise of work from the US Parks Service and quickly grew to national prominence in the United States. In the spirit of the forward looking US Parks Mission 66⁶ program the fledgling firm was

⁶ Mission 66 was a ten year park development program founded in 1956 to renew facilities throughout the US Parks. The building program included the construction of over 100 new visitor centres and additions to existing museum buildings. Mission 66 embraced the modern architectural style, expressing the values the Park Service hoped to embody over the next decade — progress, efficiency, health, and innovation. Whether or not the Park Service knew it was embracing a new strain of modernism when they engaged Mitchell/Giurgola is unclear (Stanton 2000). For further reading on

commissioned to design a visitors' centre for the Wright Brothers Memorial (Allaback, 2000). (See Figure 2.1) The Center was the 'first building to achieve nationwide recognition' for Mitchell/Giurgola (Stanton, 1977) and launched the architectural firm onto the United States national stage. *Progressive Architecture* published drawings of the design in 1959 as an exemplar of 'New Park Architecture', an upgrade from the 'rustic-rock snugery and giant-size log cabin' previously favoured ("Two Visitors" Centers Exemplify New Park Architecture," 1959). In 1961, *Progressive Architecture* published the floor plan, photographs of the finished building, and close-ups of the concrete wall and terrace design (Rowen, 1961). Two years later, the Kitty Hawk Museum was a feature of the journal's August issue. The building received praise for its planning of interior spaces that 'make visiting this national park an aesthetic as well as an instructive experience' (Myers, 1981). *Washington Post* architectural critic Wolf Von Eckardt called the visitor centre a 'simple, but all the more eloquent, architectural statement that honours the past precisely because it does not ape it' (McDougall & Mundy, 1979) The Wright Brothers Visitor Center was also singled out in 'Great Builders of the 1960's,' a special section of the international publication *Japan Architect* (E. J. Johnson, 1986), in the AIA Journal's 1971 assessment of Park Service design, 'Our Park Service Serves Architecture Well,' (Giurgola, 1975) and as an example of excellent government-sponsored architecture in *The Federal Presence* (Giurgola, 1965).

Aside from the widely lauded Kitty Hawk museum, reports on the early activities of the firm in the 1960s noted the high quality of Mitchell/Giurgola's work. *Progressive Architecture* published a number of Mitchell/Giurgola designs including their competition entry for Boston City Hall competition (unbuilt 1962), University of Pennsylvania Parking Garage (1963), Mrs T.R. White Residence (1963), the American Institute of Architecture Headquarters (unbuilt 1967), as well a profile of the firm in 1961 which included the Wright Brothers Memorial mentioned above (Rowen, 1961). The Boston City Hall and AIA Headquarters created a high level of

Mission 66 see Sarah Allaback, *Mission 66 visitor centers : the history of a building type*
http://www.cr.nps.gov/history/online_books/allaback/vc.htm

interest, particularly the latter which Giurgola eventually quit amidst disputes over changes to the design.

The degree to which the work of Mitchell/Giurgola was widely accepted during the 1960s and 1970s is also evidenced by publication in more mainstream publications. The magazine *Art in America* labelled Robert Venturi, Ulrich Franzen, Edward Barnes, Paolo Soleri, John Johansen, and Romaldo Giurgola as the 'New Talent' (Giurgola, 1977a) in American architecture. Other journals like *Interiors* ("Evolving Environment," 1960), *Pageant*, and *House and Garden* published the firm's work with plush photography but limited commentary.

From its inception the firm was noted for their association with the teachings of Louis Kahn. Jan Rowen's 1961 article placed Giurgola alongside Robert Venturi and Robert Geddes as architects who shared the desire to create spaces that evoked emotion (1961). Rowen suggested that the group had a common approach to form making which embodied Kahn's mythical 'existence will', naming the group the 'Philadelphia School' from their association with the University of Pennsylvania where Kahn and Giurgola taught.

Rowen's article opened with a full page photograph of a Kahn seated over a desk with raised pointed finger. Its caption reports that Kahn is postulating, '... to know what to do is the secret of it all...' It followed with a report and comment on Kahn's recent work, and featured Mitchell/Giurgola's Administration Building for the Academy of the New Church (1963) and American Center for Insurance Education, Bryn Mawr (1961) and the Wright Brother's Museum. Giurgola contributed a commentary on his attraction to Kahn's way of conceptualising an architectural problem:

Five years ago, at one of the faculty meetings, Kahn showed us his design for a community center and said that a school should start from this experience. It was a subjective experience, immediately projected in the dimension of a universal system in the most natural way, with no separation between the theoretic comment, the creative one, and the pedagogic. To me it was one such as I had

never seen before – bound by the reality of a place, its work, its technologies (Giurgola, 1961).

Rowen's article aligning Giurgola to Kahn set the tone for future reviews of the firm's work.

Further insight into Giurgola's design intent is described by the discourse surrounding Mitchell/Giurgola & Thomas Vreeland's⁷ entry for the Boston City Hall competition of 1962 (Figure 2.2). *Progressive Architecture* published a review of the entries in 1963 comparing the winning (and built) entry by Kallman McKinnell & Knowles Architects with the runner-up. According to the article's author, Peter Collins, the competition was object of controversial debate amongst the jury members, provoking great interest, with many lamenting the outcome (Collins, 1963). Collins noted that although both buildings appear to follow the same school stylistically, that is to say, drawn from the European Brutalism of Le Corbusier, there were wide differences. He claimed that Mitchell/Giurgola and Vreeland entry contrasted with the winning solution by bringing different elements of the program into a relationship with the contextual influence of surrounding buildings. Giurgola's entry proposed a dynamic three sided court plan which was seen as departing from a static disposition central to the winning entry. The cited design team's intention in doing so was to make the building, 'an intimate part of the re-structurisation (sic) of the area and not an isolated monument' (Giurgola, Mitchell & Vreeland 1963, cited in (Collins, 1963). Although he contrasted the schemes, Collins made no speculation as to why these differences existed.

⁷ Thomas R. Vreeland is also attributed as contributing to the design entry. Vreeland was a teacher and Giurgola's colleague at the University of Pennsylvania from 1974 until 1977.

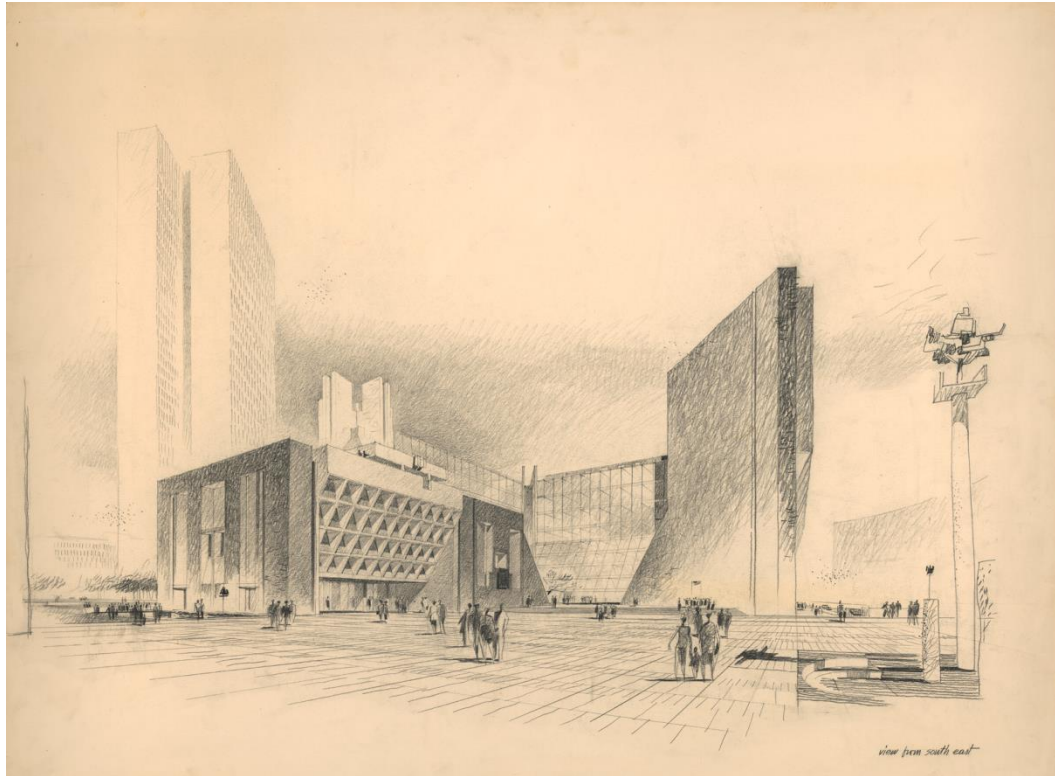

Figure 2.2 Mitchell/Giurgola Architects (in collaboration with Thomas R. Vreeland, Jr. and David Crane), Boston City Hall Competition Entry, View from South East, 1961. Courtesy of Architectural Archives, University of Pennsylvania. Ref: aap. 015.I.D.002.1. Drawing by Romaldo Giurgola.

Denise Scott Brown, discussing the ‘present state of architectural theory,’ in 1967, agreed with Rowan’s earlier characterisation of Giurgola as a follower of Kahn. She mentioned Giurgola’s own theoretical writings, emphasising his concept of the ‘partial vision’ – an idea that the architect, like all people, has limited knowledge of the abstract and the overall, and should therefore design based on what he or she can know, for a real situation with measurable dimensions and an understandable context. Scott Brown found, however, that Giurgola’s buildings do not necessarily follow his own advice, particularly the small ones that ‘may be too frail to take the weight of so much philosophy’ (D. S. Brown, 1967).

By 1969, on the same theme, the prominent Yale architectural historian and teacher, Vincent Scully, stated that Venturi and those close to Kahn were the future for American architecture. He announced, that together with Venturi, Giurgola, [Charles] Moore, [Thomas] Vreeland, and Millard were amongst ‘...the best young American

architects and educators of the past decade...'(Scully, 1969), attributing their rise to their adherence to Kahn's teaching.

In the same year, fellow Yale graduate and architect, Robert A. M. Stern introduced a concept of a 'third generation' (1969) of architects, a term coined by the modernist historian Siegfried Giedion⁸ in 1965 in the first series of the Italian journal, *Zodiac* (April 1965). Stern asserted that a 'third generation of modern architects is making itself felt' [in America]. He named Louis Kahn as the catalyst for the change between the second generation and the third generation, the second generation comprising - Philip Johnson, Euro Saarinen, Paul Rudolph - and the third, under the leadership of Robert Venturi including Kevin Roche, Paul Rudolph, Philip Johnson, Romaldo Giurgola and Charles Moore.

Stern claimed that the successive the generations can be divided by their philosophical stance. He described the first generation (LeCorbusier, Frank Lloyd Wright, Mies van der Rohe) as the heroic form givers, and the second, speaking of Johnson, Saarinen and Rudolph, as the 'formalists'. The third, he stated, were operating in opposition to the ideal formal and social agendas of the second which he claimed,

...deals in pure and simple shapes often at the expense of problem solving. It is an attitude which separates problems of shape (universal and abstract in its view) from problems of function (particular and less significant).

Stern further explained their differences through reference to Charles Moore's characterisation of 'exclusive' and 'inclusive', - the second generation being exclusive and the third inclusive. Of Giurgola, Stern concluded that his Italian origin contributed to a gentler modernism,

...a more expansive and less intense talent than Venturi or Kahn's, from which it has drawn so much sustenance. An Italian by birth, his is a

⁸ Gideon had put considerable investment into the thread of modernism and preferred to see the rise of this new generation of architects as a riff on the same theme.

sensibility that sketches with soft lines and gently shaded areas (Stern, 1969).

To further assist his explanation of the philosophical rift between generations, Stern described the contest within a jury that resulted from a competition for housing at Brighton Beach, Brooklyn, New York in 1968. The first prize was awarded to a scheme by Jerry A. Wells and Fred Koetter. Some in the jury, however, preferred Venturi's entry. Those who dissented, including Giurgola, Donlyn Lydon and Richard Ravitch, supported Venturi's contextual approach. They stated that his entry '...offers real benefits for the people who might occupy it rather than polemical satisfaction to those who consider it' (Stern, 1969). However, Phillip Johnson, who presided over the jury described Venturi's entry as '...the most ordinary apartment construction built all over Queens and Brooklyn since the Depression, that the placing of the buildings was ordinary and dull.' In Stern and Scully's accounts, Giurgola's individual contribution is not well explained.

'Grays' and 'Whites'

By 1973, two schools were reported to have emerged in the United States following the almost simultaneous publication of *Five architects* (Wittenborn, 1972) and Robert Venturi's *Learning from Las Vegas* (Venturi, Scott Brown, & Izenour, 1972). Peter Eisenman, Michael Graves, Charles Gwartzmey, John Hejduk and Richard Meier were reportedly little known beyond a small circle of academics and a handful of clients for whom they had built small houses in places like Princeton and eastern Long Island. Soon, they were 'The Five', standard-bearers of a movement to elevate modernist architectural form into a theoretical pursuit. After that, they rose in a stunning trajectory, from the status of cult figures of the late 1970s, to full-fledged celebrities of the 1980s (Goldberger, 1996).

In response Robert A. M. Stern organised a team whose orientation was 'more or less opposite to that of the Five (1973), inviting them to contribute criticism of the five architects. Their responses were published in the May edition of the American journal, *Architectural Forum*. Contributing were Jacquelin Robertson, Charles Moore, Allan Greenberg and Romaldo Giurgola. The opposing points of view, as Stern saw it, were 'European/idealist on the one hand, American/pragmatic on the other, exclusive

and inclusive, conceptual and perceptual, invulnerable and vulnerable’, later referred to as the ‘grays’ and the ‘whites’⁹. Stern (1973) stated,

The fundamental problem is with the conception of architecture as insistently new, abstract and divorced from the place in which is built: from its landscape and from its architectural tradition which are, after all, the record of experience over a long period of time.

Charles Moore (Moore, 1973) contributed

I do not share the authors’ veneration for the modern movement. I would claim in justification that firstly, the profound differences that distinguish the work of its masters, Mies, Corbu, Terragni, Aalto and Brueur, are more significant than their membership in the CIAM [Congrès internationaux d’architecture modern].

Finally, Giurgola (Giurgola, 1973) gave a stinging review:

...by operating on what is asserted to be an exclusively formalistic level, they force themselves into an experienced, older vocabulary as if to exclude for themselves the possibility of finding forms adequate to their time. Since form per se cannot be invented, the alternative left to them is to recall what has been seen.

Later on, the exchange was understood to be contrived by Eisenman and Stern, but nonetheless, it marked a change in the way architecture was talked about in the United States, and the emergence of a critical architectural culture (Crosbie, 2011).

The first endeavour to address the theoretical underpinnings of Giurgola’s work came in 1979 with an article by David Bell, entitled, ‘Unity and aesthetics of incompleteness in architecture’. Citing Mitchell/Giurgola’s MDRT Foundation Hall at American

⁹ The gray and white names reportedly came from the type of cardboard used to make their models. Philadelphians used a grey ‘flecked’ board whereas New Yorkers used white museum board (H. Guida, 2014)

College in Bryn Mawr (See Figures 2.3 & 2.4) and the Penn Mutual Life building in Philadelphia, Bell suggested the unlikely grouping of Alvar Aalto, Kahn, Venturi, Giurgola and Peter Eisenman as illustrative examples of an 'aesthetic of incompleteness' (1979). Bell described incompleteness as the opposite of the concept of unity. Unity, he sees, as a value that has been invested persistently in architecture, but changed over time 'as man's consciousness of himself and his place in the world has expanded'. In a building it is manifest in 'a coherence among its various parts' which is the physical link to orientating human experience.

Since the Renaissance, Bell claimed, the Western view has predominantly valued the rational organisation of events and matter. However, more recent thinkers, such as Michel Foucault, have suggested that this is only one of the many ways of ordering the objects of experience. The central argument then of Bell's article is then that an aesthetic of incompleteness holds that the most meaningful appreciation of space and form occurs when the physical elements which define them are implied rather than complete. Bell wrote,

'The aesthetics of incompleteness acknowledges the participation and interaction of any artefact with its context...When enclosure is implied rather than explicit, the situation arises which asks the observer to complete the figure in the observer's own terms, mentally constructing space and its modulation...'

To illustrate his concept, Bell offered Michael Graves's Hanselmann residence as an example of a composition that challenges the notion of unity as defining the value of an architectural object. The house is composed of two parts; one effectively almost a complete cube physically, the other juxtaposed element meanwhile is almost absent. And yet, Bell claimed, the two elements work together to form a single artefact in the landscape. Being viewed at once whole and simultaneously a ruin of itself introduces the intangible aspect of time, and hence brings it into closer alignment with the human experience.

Bell went on to identify several further examples of his aesthetics of incompleteness. Aalto's irregular and ruin-like compositions, such as is exemplified by the Säynätsalo Town Hall, along with his choice of materials such as brick, stone, and tile, having

rough and imprecise character, acknowledge the force of nature and project the eventual demise of the building. Bell commented that one of the strengths of the ruin as a model for architecture is that it illustrates, 'the necessity for architecture's dependence on temporal contexts.' In Louis Kahn's architecture, Bell sees the quotation of well-known historical forms, such as those derived from ancient ruins, as his awareness that a ruin holds the 'promise of becoming'. In the Erdman Dormitory (See figure 7:14) Kahn composed the plan in three large courtyard squares, aligned along their diagonals and overlapping at their corners, forming a small square at the overlap. In Bell's view the pattern of dark and light along the axial alignment, highlighting the spontaneous spaces made by the overlap, Kahn recreated the impression of a ruin that is simultaneously unified and a fragment.

It is the importance of an appearance of incompleteness that Bell argues Kahn passed on to his two students, Robert Venturi and Romaldo Giurgola. For Venturi, as expressed in his *Complexity and Contradiction*, our perception of unity in architecture is dependent on the object's context and the difficulty of achieving a 'whole'. In Giurgola's architecture, Bell argued that, like Venturi, Giurgola sees 'buildings as fragments of a larger pre-existing context...part of a continuum of larger social, political, cultural and physical contexts beyond the range of perception.' Translating this concept into artefact, Giurgola used asymmetrical compositions of solids and voids. In Giurgola's MDRT Foundation Hall, 'the massing gives the impression that there is more to be added to the building.' Bell also noted Giurgola's frequent articulation of the façade from the main volume in which the façade is manipulated to respond to its context.

While this is only one way of approaching Giurgola's work, this idea of incompleteness can also be seen in Giurgola's own writings, as he often discussed the nature of buildings as fragments, and the importance of a dynamic and continuous relationship between a building and its surroundings (Beier, 2006).

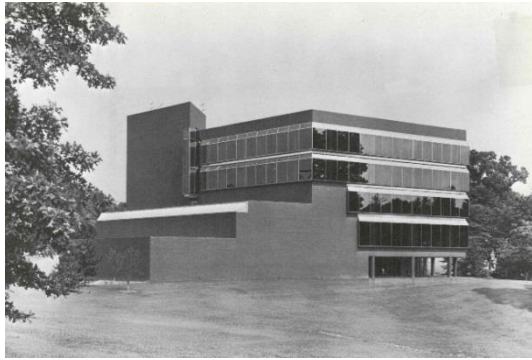

Figure 2.3 Mitchell/Giurgola Architects, MRDT Foundation Hall, Bryn Mawr. Photograph by Rollin R LaFrance. Courtesy of The Architectural Archives, University of Pennsylvania. Ref: aaup.015.V.008.1

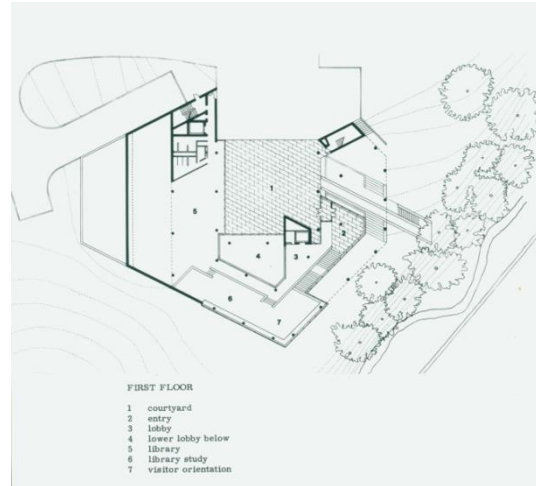

Figure 2.4 Mitchell/Giurgola Architects, First Floor Plan, MRDT Hall, Bryn Mawr, 1969. Courtesy of Architectural Archives, University of Pennsylvania. Ref: 015.V.007.2.

Two complete overviews of the work of the firm are provided by monographs published 6 years apart in 1977 and 1983. The 1977 publication *Process Architecture No.2* presented 22 Mitchell/Giurgola buildings, including presentation photographs and drawings of their major projects from the past 20 years of the firm. It contains an article by Phoebe Stanton (Stanton, 1977)¹⁰ who stated that in her opinion Mitchell/Giurgola had emerged as ‘a valid new direction in design’. Stanton noted that Mitchell/Giurgola buildings set themselves apart by the way in which they respond to their ‘larger environment’. In reconsidering the Modern Movement she claimed is evident in the work of Mitchell/Giurgola she notes the influence of Kahn, use of the plan diagonal and their ‘thoughtful exploitation of natural light to create dramatic effect’. Stanton also remarked on the overall effect of a ‘human scale’ of their compositions. Further she noted the variety of Mitchell/Giurgola’s buildings, which she saw as falling between two poles. At one extreme was the ‘tense, clean kind of minimal statement dependent on direct evidence of structure and materials’. In this category she mentioned the ‘dramatic statement’ of the Liberty Bell Pavilion

¹⁰ In 1977 Stanton was Professor in the Department of History of Art, John Hopkins University, Baltimore. Stanton also wrote a regular feature on architecture for the *Baltimore Sunday Sun* 1971-76

(1976) to the ‘refined and recessive, blending into the city and the countryside’ of the Subway Concourse in Philadelphia (1971), the Indian Point Simulator and Visitor Center in Buchanan (1974). At the other pole, Stanton stated, was the ‘search for form which Kahn stressed’. In this category she praised the Wright Brothers Memorial Visitor Center, the Administration Building for the Academy of the New Church (1963), the unbuilt Arcadia National Park Headquarters, Bar Harbor (1965), the William Jeanes Memorial Library (1967), and the Headquarters Building of United Fund (1971), which she considered to be a masterpiece of this type. Her preference was for the latter ‘pole’.



Figure 2.5 Interior of Liberty Bell Pavilion, completed in 1975. Photograph by Jack E. Boucher, 2003. Wikimedia Commons.

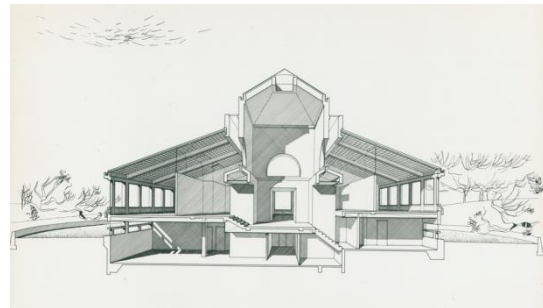

Figure 2.6 Mitchell/Giurgola Architects, Bryn Athyn Academy - Administration Building, 1963. Courtesy of The Architectural Archives, University of Pennsylvania. Ref: aaup.015.V.001.3.

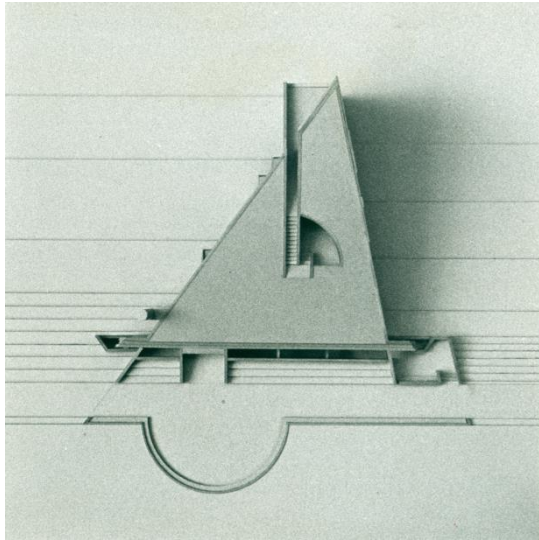

Figure 2.7 Mitchell/Giurgola Architects, Acadia National Park Headquarters, 1965–unbuilt.
Photograph by Rollin R. LaFrance. Courtesy of The Architectural Archives, University of Pennsylvania. Ref: aaup.015.V.056.2



Figure 2.8: Mitchell/Giurgola Architects, Headquarters Building of United Fund, 1971.
Photograph by Rollin R. LaFrance. Courtesy of The Architectural Archives, University of Pennsylvania. Ref: aaup.342.L.69.c

At the back of the monograph, the editor, Ching-Yu Chang, also sought comment from four of Mitchell/Giurgola’s American peers: Thomas R. Vreeland, Jr., Victor A. Lundy, Paul Heyer, and Ulrich Franzen. Vreeland, Lundy and Heyer mentioned Giurgola’s relationship with Louis Kahn. Vreeland (1977) remarked that Giurgola’s lyricism needed the anchoring, bounding influence of Kahn, adding that Kahn showed him how he could ‘tap back into his Italian heritage ... for which European modernism gave him sanction’. Lundy, mirroring Stanton’s comments elsewhere in the monograph, wrote of his respect for Giurgola in going beyond self-realisation and self-indulgence to engage with the ‘larger dimension ... to help keep cities on a solid course and the planet in good shape, obligations to other buildings, people, issues ...’. Heyer, meanwhile, noted Giurgola’s use of geometry to create a narrative of spaces as a vehicle for bringing the building into ‘strong dialogue with their context’ (Heyer, 1977). For Franzen (1977), at the heart of Giurgola’s work was an understanding that architecture cannot be black and white remarks, alluding to the gray vs white debate

described later here. Giurgola's work encompassed '... both abstract ordering devices as well as fragments of reality'.

The second and more exhaustive overview of Mitchell/Giurgola Architects in 1983 presents a greater number of their works and contains a foreword by Kenneth Frampton. Frampton described Giurgola's work as affected by, but quite separate from, that of Louis Kahn, and also noted the influences of Alvar Aalto and Eero Saarinen on Giurgola's earlier buildings. As well, Frampton discussed Giurgola's idea of architecture as fragment leading to the construction of 'narrative landscapes' in the buildings and especially the university campuses designed by Giurgola, which are experienced as a series of views and elements as one moves in and around the composition.

Unlike Scott Brown's earlier comments that the smaller buildings do not always hold up the weight of Giurgola's theories, Frampton finds that the modest works, such as the Tredyffrin Library, are often the exemplars of Mitchell/Giurgola's sensitive approach to site conditions. However, in the larger scale works Frampton expresses concern that, along with the benefits in a looser approach to modernist dictates that allow strict geometries to be inflected, and unexpected fragments introduced, Mitchell/Giurgola's projects sometimes lack focus. For Frampton, at the American College Campus at Bryn Mawr, it is difficult to recognize an overarching structure in the master plan, and contrary to Bell's earlier view that their appearance of incompleteness is a unifying characteristic, the individual buildings lack consistency, assuming 'different morphologies'. Frampton accounts for the latter of these criticisms by recognising the evolution of Giurgola's architecture from the 'Brutalist syntax' of the Foundation Hall (1972) (Figures 2.3 & 2.4) to the 'Expressionist scheme' for the Graduate Centre (1981) over the decade in which the campus was developed from 1966 to 1981. In the space allowed for Frampton's foreword, there is little explanation as to why he believes Mitchell/Giurgola's trajectory changed over the period, and no comment from him as to whether the evolution coincided, or differed, from a broader architectural narrative. Nevertheless, the Graduate Centre, which has a plan arrangement reminiscent of the geometric dynamics of Aalto's

Paimio Sanatorium, Frampton notes, is one of Mitchell/Giurgola's finest works of the period.

The 1983 monograph follows on to present Mitchell/Giurgola's work under five categories according to type of 'place': meeting places, houses, places for work, places for study, and urban places. The emphasis on place, or use, defining the category into which one building might fall makes it difficult to determine how certain projects were classified. For example, the academic wing added to the University Museum at the University of Pennsylvania was considered to be a meeting place rather than a place for study. Despite the sometimes confusing layout, the monograph nevertheless successfully highlights the public or institutional nature of many of Mitchell/Giurgola's projects, supporting Frampton's (1983) claim that Mitchell/Giurgola's achievement was rare in that it 'succeeded in creating a large body of public work which is sensitive, appropriate, economic and beautifully built.'

In 1985, Pause and Clark (1985) analysed four of Mitchell/Giurgola's buildings among 64 selected buildings, that in their opinion, 'represent a range of time, function, and style, and architects who exemplify seemingly different approaches to architecture ...'. Pause and Clark's examination first looked at the buildings individually through drawings and diagrams, and then arranged them in 'formal archetypal patterns, or formative ideas', looking for a theory 'which transcends the moment and reveals an architectural idea'. Their themes included: structure, natural light, massing, plan to section or elevation, circulation to use-space, unit to whole, repetitive to unique, symmetry and balance, geometry, additive and subtractive, and hierarchy. Figure 2.9 shows Pause and Clark's analysis of Mitchell/Giurgola's Foundation Hall. While these types of geometric analysis are useful in revealing themes across architects' work, as will be discussed later, they need to be treated with some caution for the reason that they are not unconditional. An architect may well admit to a degree of geometric underpinning of a design, but also may argue that the final product is as much a deviation from it (Paul-Alan Johnson 1994). In Giurgola's architecture the deviance from its order, as noted by other critics, is often composed in relationship to contextual forces. For instance, Pause and Clark present the MRDT Foundation Hall as understood from a series of overlays on the geometry of the square

plan, and yet, it is a building as much planned around the sloping topography of the site and views overlooking a stream and small lake as its geometric *parti*.

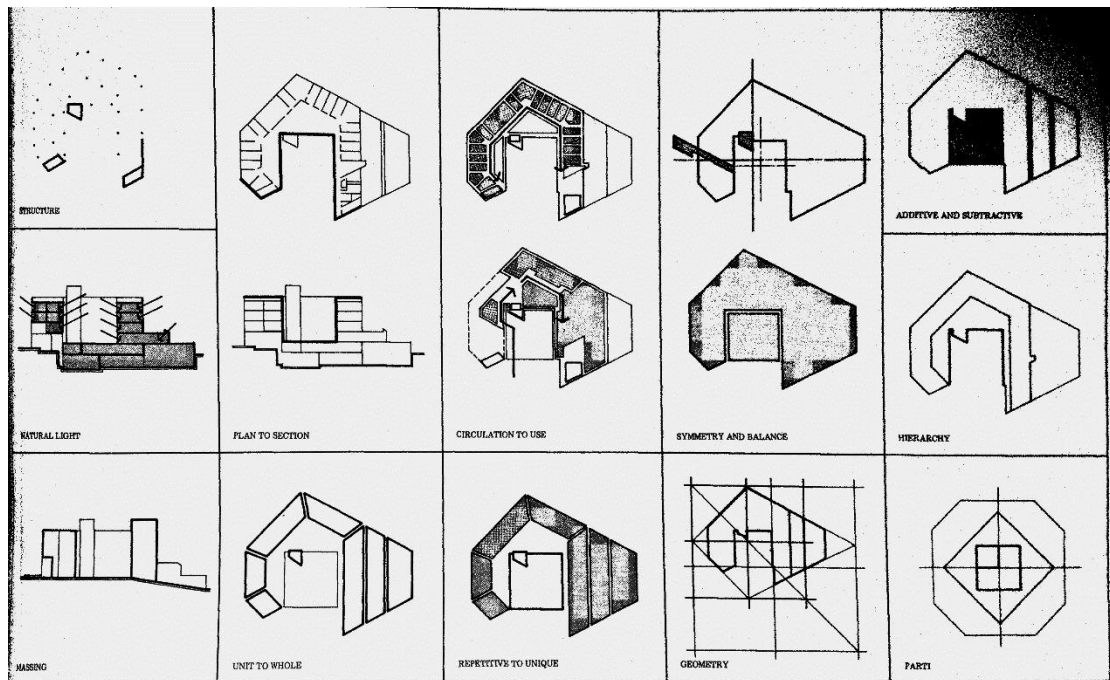

Figure 2.9: Clark and Pause's (1985) analysis of the MRDT Foundation Hall, 1972

Australia

Unsurprisingly, the Australian Parliament House competition and its outcome created a buzz in architectural and mainstream media. The announcement in 1980 of Mitchell/Giurgola, and the young Australian Architect, Richard Thorp as the competition winner was published widely. Reviews of the announcement were cursory, generally approving and did not attempt a thorough examination¹¹. However, there were some murmurings in Australian architectural circles about the value of the winning design.

The opening of Parliament House in 1988 brought the opportunity for a more thorough study of the built result against the promise of the competition. Some upheld their initial praise for the design being 'The Right Answer' for the Griffin/Mahoney

¹¹ A more complete review of the literature surrounding the New Parliament House is provided in Chapter 4.

plan and the Australian people (Jennifer Taylor, 1988). Rory Spence, a regular contributor to *Architectural Review*, commended the parliament building for a 'brilliant resolution of seemingly contradictory criteria'. He noted the building's response to the Griffin/Mahoney plan, the access over Capitol Hill as symbolic of the 'democratic subordination of parliament to the people', the clarity of the plan, its formal and spatial resolution, and art program as positive contributions. He remarked, however, that many aspects of the building were '... puzzlingly bland' (Spence, 1988).

Later, the Harvard graduate, James Weirick (1989), then professor at RMIT, and head of the then recently convened Walter Burley Griffin Society, delivered 60 pages of 'Critical Response' to Parliament House in *Transition* 7. Weirick contended that Giurgola's design never got past the diagrammatic stage and failed to provide the same cultural challenge that Griffin had delivered in the design of Canberra. He also claimed, echoing Denise Scott Brown's comments 20 years earlier, that neither did the building live up to Giurgola's philosophy. Paulo Tombesi (2003) argued that the hang-over resulting from the infamous procurement of the Sydney Opera House had a much greater influence on the parliament building design than had been previously portrayed. A 'Pragmatic Classicism', he labelled the result.

Following Parliament House, Australian buildings in which Giurgola had a direct role continued to be published by the local architectural press, albeit briefly. *Architecture Australia* featured the St Thomas Aquinas Church (1991), the University of New South Wales Scientia Building (2000) and St Patricks Cathedral (2002). *Monument* and *UME* magazines published the Cathedral project and *UME* also published Giurgola's weekend house in Lake Bathurst. All publications included photographs of the buildings and short texts pointing to their main features and a degree of reflection by recognised critics.

In 2000 a symposium held in Sydney 'To honour architect Romaldo Giurgola in his eightieth year', looked at Giurgola's work and contribution to the art of architecture. The program was divided into four sessions: (1) Philadelphia/New York; (2) Conversation with Aldo Giurgola; (3) Parliament House, The Art Program; and (4) Parliament House, Urbanism. Prominent members of Australian architectural

academia as well as artists associated with Parliament House spoke on the various aspects of Giurgola's work, from the early years in the United States up until Parliament House. The keynote address was presented by Paolo Tombesi. He discussed the 'Roman years' of Giurgola until 1950, arguing that Giurgola's arrival in the United States was 'more of a development of an already defined cultural trajectory' (Tombesi, 2000). Building on Bourdieu's concept of *habitus* (Bourdieu, 1990), Tombesi connected Giurgola's formative experience in Italy with his mature design approach in America and Australia.

In the Philadelphia/New York session, the architectural historian Conrad Hamann reviewed the 1960s work of the firm, noting the 'antecedent work' of Kahn, Aalto and others (Hamann, 2000). Harry Margalit examined the 'Philadelphia / New York Years', noting Giurgola's 'distrust of formalism' and his criticism of the 'self-referential design methods' of the New York Five, but, Margalit noted Giurgola's fondness of formal devices such as the diagonal (Margalit, 2000). Gevork Hartoonian addressed Giurgola's input in the gray vs. white debate noting that there was much to learn from Giurgola's architecture in the re-invention of historical typologies, as opposed to pursuing the 'anonymity and abstraction' of the 'futility of revitalising the project of modernity' displayed by the Whites (Hartoonian, 2000). Maryam Gusheh reviewed the contribution of the Philadelphia School to the 'otherwise disparate and chaotic mood' of the 1950s noting that Kahn's discourse on the role of 'institutions' to evoke an 'inspired way of life' remained a central focus in the Mitchell/Giurgola practice (Gusheh, 2000). She commented that the remoteness and distance of their respective parliamentary projects provided Kahn and Giurgola with an 'idealised pallet' for implementing Kahn's conception of an inspiring democratic institution. Similarly, Martin Hayes, in discussing Giurgola's writings, related Giurgola's architectural philosophy to Kahn and Venturi and cited architect and theorist Manuel de Sola Morales in saying that Giurgola's planning schemes were 'perhaps not as well-known as they deserve to be'.

In the Parliament House session, James Weirick, in more conciliatory tones than his review of the building in 1988, discussed the parliament building in the context of other 'great expressions of the democratic spirit in the twentieth century' (Weirick,

2000). He noted the subtlety of Giurgola's work in the fusion of landscape and urban space, and the 're-awakening' of the Griffin/Mahoney Canberra plan. Following Weirick, Haig Beck and Michael Jasper continued with further discussion of Parliament House and its relationship to the Australian context. Beck interpreted the symbolic meaning of Parliament House that, in his view, is apparent through encoded historical references in its planning, materials, finishes, detailing, and craft and art works. In his paper, Jasper reflected on the urban presence of the building and three aspects of its urbanism: 'the plan; flattened space; the profile'. Jasper (Jasper, 2000) found that Giurgola's plan contradicts 'the strict formality and sterile monumentality of the criticised solutions while bearing some surface resemblance'. Other speakers included the long-time advocate of the Parliament House design, Jennifer Taylor, who reiterated her early support, and Peter Meyer who praised Parliament House for its evocation of 'a sentiment far more ancient than the comfortable disposition of an Antipodean Garden City' (Myers, 2000). This, Meyer claimed, was achieved by following a 'melancholic tradition' stemming back to Roman antecedents.

Artists who worked on the parliament building praised Giurgola's collaborative working methods and foresight in establishing an art program from the outset of the project. Pamille Berg (Berg, 2000), who coordinated the art program, spoke of Giurgola's 'intense interest in collaborating with artists and craftspeople'. She related Giurgola's fragments to human memories that can be distilled equally from the experience of art and architecture. Of particular note to later discussion in this thesis the Danish artist Lin Utzon (1984) spoke of her work with Giurgola at the Volvo Headquarters in Gothenburg, Sweden to which she attributed the launch of her career in ceramic and textile art. Little mention was made at the 2000 symposium of Giurgola's other Australian works, perhaps inferring that his contribution to the artistic development of architecture in Australia was considered concluded with the parliament building.

A similar event was held ten years later in 2011 to celebrate Giurgola's 90th year. Entitled 'The Reluctant Master: A Symposium to Honour the Life and Work of Romaldo Giurgola', the symposium was similarly structured around four sessions, in chronological order covering the places where Giurgola taught and practiced - Rome,

Philadelphia, New York, and Canberra. Of note to this thesis is the lecture by the Roman architect Dr. Riccardo Vanucci, who cited many architectural values shared between Giurgola and the Italian architect Mario Ridolfi, an influence that would carry through Giurgola's entire career. Also of particular relevance is the presentation by Stephen Frith entitled, 'Past exchanges in the work of Romaldo Giurgola' referring to the conversations he had had with Giurgola over several years from 2000 to 2009 and the cultural exchanges Giurgola inherited from an education in Rome and his career in the United States. Frith's paper looked at Giurgola's architectural training at the Università di Sapienza and the significant Italian Rationalist architects who had a great influence upon his work as well as the importance of the commissions Giurgola received from Volvo (Frith 2011).

Giurgola's writing (1962–2010)

1960s–1980s

During the 1960s and 1970s in the United States, Giurgola published several articles in architectural journals and magazines and an entire book on the work of Louis Kahn following Kahn's death in 1974. These works address a number of related ideas that contribute to the understanding of his designs and way of working, particularly his ideas of architecture as fragment, the importance of context and designing for specific places and the idea of a 'partial vision', which he outlined in his seminal article in the Yale architectural journal, *Perspecta* (Giurgola, 1965).

Giurgola began relating his ideas on the development of cities and the role of the past when he was Associate Professor of Architecture at the University of Pennsylvania. In papers produced following a conference entitled, 'The Architect and the City', held at the Cranbrook Academy of Art in 1962, Giurgola wrote that a 'unified vision of the city life has been lost' (Giurgola, 1962). He went on to detail past visions across Europe and America, particularly the misconceptions of functionalism in the post war transformation of European cities. He stated that the full range of needs of city dwellers cannot be addressed by technical solutions alone. Giurgola compared historical city redevelopment with recent and contemporary proposals in London, Paris, Amsterdam and Philadelphia. He concluded that the essence of city vitality is an 'artistic order' that has primacy over function, and that the interior spaces of cities

rightly determine their form. Referring to Husserl's *Lebenswelt*, Giurgola states that a successful and 'authentic' intervention in a city must study its 'content' (the 'historic, social and natural experience') and 'form' (the city's style, rhythm and measure). The references to philosophical and literary works outside of architecture was a common theme amongst Giurgola's contemporaries inside the Yale/Penn enclave, such as Venturi and Moore. The article also demonstrated Giurgola's broad depth of knowledge of past and contemporary city planning theory and practice. He cited as experiments that he saw exhibited promise of fulfilling his wish for more dynamic and poetic cities recent projects by the Metabolism Group, the Smithsonian Hauptstadt Berlin Competition (1957), Aalto's Plan for Helsinki (1954), Tange's Tokyo Bay Project (1961), Quaroni's Venezia Mestre Competition (1958).

Two years later, Giurgola wrote along similar lines for the University of Michigan publication, *Dimension*, addressing the 'Early Stages of an Idea in Architecture' (Giurgola, 1964). The article featured images of Mitchell/Giurgola's White House (1963) and first buildings of a new residential for 40 students at the Bryn Athyn Academy of the New Church (1962). Giurgola discusses the impacts of globalisation, urbanism, and the legacy of the high modernists, progress in technology and obstructions in the progress of art. He expressed his concern with the translation of European modernism, stating that architects have for too long 'been producing the diluted essence of their discoveries'. He remarked that the focus on formal appearance and technology overlooks the reality of the event of architecture. Instead, Giurgola proposed, similar to his earlier article on city planning, that buildings need to be conceived from the inside out. In explaining this concept he uses the example of the Baroque city where the vitality and 'continuous vibration' of the city is the result of a 'multidirectional architectural sequence' that is generated from the dynamic of the interior. These ideas were the basis of his later criticism of the 'the New York Five' mentioned earlier (Giurgola, 1973).

In this article Giurgola also provided insight into his highly intellectualised way of working on a design problem. He explained that for him architecture is a discovery of 'limitation' and 'measure of space' that affects every part of the construction and the immediate environment. He described a meditative process by which he 'accepts

modestly' competing parameters, without exclusion. By undertaking this meditation the architect is then better placed to apply his or her 'will' and 'imagination'. He warned against applying preconceived ideas such as the 'exaltation of technology as an end in itself' or focusing only on a rational/functional solution to a list of programmed spaces. This was a theme that Giurgola regularly returned to in his later writing.

By 1965, Giurgola further developed and articulated his thoughts on the ordering of urban spaces. In his most well-known article, 'The Realism of the Partial Vision' he described a concept he called 'partial vision'. Partial vision is a method by which architects would produce each architectural event with less focus on universal social theories. Instead, the view should foreground 'sympathies and human aspirations' (Giurgola, 1965). It was also the article in which he expressed his later oft-quoted 'fear of theory', claiming that 'too often a theory or a competent principle counts more in essence than in realisation'. Giurgola again wrote of the importance of the past as a reference where, in speaking of city development since the turn of the century, 'The old must exist with the new. The city is a complex of poetic essence'. Further, with language echoing Robert Venturi, he argues that 'a complexity of partial visions is sought'. However, the notion of a partial vision never took hold in the same way as Venturi's more charismatic slogans. The same publication, edited by Robert Stern, contained articles by Charles Moore, Philip Johnson, Louis Kahn, Vincent Scully, H.R. Hitchcock, Paul Rudolph, G.L. Hersey, Peter Millard, and an extract from Venturi's *Complexity and Contradiction* which he would publish in 1966.

Following the period of fairly sustained contribution from 1964—1966, Giurgola appeared to take a pause from writing on design theory and instead concentrated his efforts on recording the work and life of Louis Kahn. In 1967, Giurgola wrote for *Zodiac* on Kahn's contribution (1967), in 1969 for the French magazine, *L'Architecture D'Aujourd'hui* (1969, p. 4), and in 1974 upon the Kahn's death for *Progressive Architecture* (1974). The writing on Kahn reached its high point in 1975 when, with Jaimini Mehta, Giurgola produced the first entire book dedicated to Kahn (Giurgola & Mehta 1975). Six years later Giurgola wrote a follow up piece on Kahn for *AIA Journal* (1982a).

In the late 1970s, Giurgola wrote three smaller articles in which he returns to his ideas in the 1960s. He attempted to reconcile the reality of building with what he considered to be the dual artistic and social role of architecture but there is a noticeable shift in his language away from the concepts of ‘measured space’ and ‘order’ developed alongside Kahn and Venturi, to speaking about the concept of ‘place’ and ‘morality’ in architecture (1975, 1977b, 1980, 1981a). There are signs of Giurgola’s divergence with Venturi as his writing is critical of the use of pop-art imagery as an appropriate source for content in architectural production.

In ‘The Aesthetic of Place’ (1977), he distinguished ‘place’ from ‘space’ by describing place as the poetic experience of a unique locale, whereas space ‘has to do with numbers and geometry’. He related the making of a place with the building up of fragments over a number of episodes and layers of historical development. Although Giurgola rarely cited his sources, or did so obscurely within the text, his use of these concepts was undoubtedly influenced by the rise of phenomenology in the late 1970s, a concept which developed from the writings on subjective experience by the philosophers Husserl and Heidegger, and was being actively translated into architectural thinking by architectural theorists such as Christian Nordberg-Schulz¹².

Following the announcement of the Parliament House competition, Giurgola wrote a poetic piece entitled ‘The Producing Moment’, in which he described his formative experiences as a child in Rome; at the age of 19 when he visited ‘Asplund’s Copenhagen’; and a second experience when he arrived in the United States, his visit to Jefferson’s University of Virginia. According to Giurgola, it was these specific encounters that established his conviction that architecture is ‘an idea’ and a ‘phenomenon’. For Giurgola, the ‘thought’ of a building is present together with the ‘process’ which is made more readable through the identity of its elements, the

¹² In the 1970s, under the influence of Dalibor Vesely and Joseph Rykwert, the School of Comparative Studies at the University of Essex was the breeding ground for a generation of architectural phenomenologists. These included David Leatherbarrow, later professor of architecture at the University of Pennsylvania.

character of its parts (Giurgola, 1981b). In ‘An Open Letter to Students and Colleague’ in the same year, Giurgola called upon teachers of architecture to make the study of ‘measured space, adequate and calibrated to its human purpose’ central to their education. As in his earlier writing on urbanism, in these articles Giurgola made eclectic and uncited reference to writers outside architecture to support his discussion - writers in art history, literature, and philosophy.

When speaking of morality, he wrote, ‘It seems to me that it is impossible to assess it without taking into account the morality of the personal act’ ‘...[E]thics’, he went on, ‘enters into architecture in the form of the relationship between art and morality, or between the realm of the beautiful and the good’ (Giurgola, 1980). An ethical act of architecture, he claimed, is undertaken when the personal act seeks to do good work. He contrasted this with acts of architecture that seeks to desire merely the beautiful, monuments produced under dictatorships, or ‘virtual images’ of architectural prototypes – referring to pop architecture.

To achieve these aims Giurgola described internalised narratives that he called an ‘itinerary’, in which architectural references to past traditions are strung together in a story board. In his article of 1979—81 Giurgola wrote:

In all of these instances, architectural forms depend on the definition of an itinerary; they are forms bound to complex conditions rather than generalised assumptions, and composed in such a way that they allow a continuity between episodes and fragments. They come into being as a result of the intention that one walks through them should feel, as in a poem or music, as if one is in the midst of an endless environment (Giurgola 1981).

Giurgola was not a prolific writer during his time in the United States, but made pronouncements at critical points in his development. His writing is much like his buildings of the same era: understated, well composed, and not ostentatious. From his writing one can also gather up a picture of his inner reflection, in which, throughout his texts, he attached himself to the humanistic writings of progressive periods that he brought to bear on his designs.

Australia: 1980s–2000s

From 1981 onwards Giurgola was regularly invited to speak in Australia and the United States. In 1982 he gave the Walter Burley Griffin Memorial Lecture in which he reiterated his views on the creation of ‘places’ as distinct from ‘sites’. He used the city of Canberra as an example to flesh out his views. He also laid out the principles by which he states that Parliament House was designed. They were:

- *a response to ‘two kinds of rules: the order of the city...and the order of the land’;*
- *‘the view of it as well as the view to it...’;*
- *‘...[t]he building must confront in its scale the scale of the landscape...’;* and
- *‘... eliminating an ambiguous distinction between environment and landscape’(Giurgola, 1982b).*

In 1986 Giurgola delivered the Ian McLennan Oration at the University of Melbourne. He spoke again of place, defining place as the meaning of a geographic location as in the Greek ‘logos’, and how in designing Parliament House he wished to ‘evoke the power of that particular selected place...in its aggregate of elements and sources, is far stronger than what a single, isolated building might convey in its physical reality’(Giurgola, 1986). Giurgola (1987) chose a similar topic for his acceptance speech for the Thomas Jefferson Medal in Architecture. In this speech he concentrates more on American examples of places and their meanings. At the National Landscape Architecture Students Conference five years later, Giurgola (1992), spoke of the notion of authenticity as it applies to architecture, with reference to the American literary critic Lionel Trilling. He considered that masterpieces of architecture, authentic architecture, are ‘both apart from, and part of the environment in which they exist’.

Into the 2000s Giurgola spoke at several public events related to the planning and development of the city. On each occasion, citing Ebenezer Howard’s self-sustaining ‘garden city’, and with echoes of Christopher Alexander’s ‘Distribution of Towns’, Giurgola described his vision for Canberra and its regions. He argued that Canberra should establish limits to its urban sprawl and suggested that regional centres based on a cluster of existing towns, such as Yass, Gundaroo and Bungendore, could be

developed into larger towns to support population growth in the broader region, separated by farming land and natural areas. Although offering no clear justification on the figure, according to Giurgola, the population of Canberra ought to be limited to between 300,000 and 500,000 (Giurgola, 2002a, 2002b, 2005).

Following the completion of the Parramatta Cathedral, Giurgola and Pamille Berg (2006) published a substantial book on the building. Some 185 pages richly cover the building's architecture and its art program with photographs, sketches, working drawings and commentary on the design process. In the introduction to this latest work, Giurgola returned to many of the concepts that have informed his past architecture: synthesis, content, limit, narrative, collaborative work, ethical space, and a consideration for the surrounding context. Giurgola explained the cathedral design as a 'modest effort' towards each of these principles.

Some Common Themes

Contextual modernism

From close to the beginnings of Mitchell/Giurgola in 1958 commentators of Giurgola's work recognised a distinction from European rationalist/functionalist ideology and the International Style as it was being codified in the United States. A common observation was Giurgola's consideration of the context within which his designs sat, and that these strategies set Mitchell/Giurgola apart from their contemporaries, including Louis Kahn.

While it was not expressly noted about the earlier Wright Brother's Center or White House, the discourse surrounding the Boston City Hall competition (1962) foregrounded Giurgola's use of varying scale and disposition of elements to acknowledge the existing structure of public spaces and settings of adjacent historic buildings (Collins 1963). Of his competition entry it was also noted that the building's facades varied in the choice of materials and configuration of openings according to the setting onto which they faced. According to Collins these strategies were 'attempts to establish a rapport' with surrounding buildings. A former colleague of Giurgola's later argued that the relationship with surrounding buildings was a broader criticism of modernism,

It is clear that the tension created between the monumentality of architecture on one hand and the subtle place-making on the other lends to an ambiguity yet unfamiliar to the orthodox modernist discourse in architecture (Mehta, 2011).

Ten years later, reviewing the Mission Park Residential Houses for *Progressive Architecture*, David Morton (1973) observed that the new dormitory complex for 294 co-ed students, large in comparison with the campus's historic buildings, 'enriches its surroundings even it is distinctly unlike any buildings around it – in style and plan, in size and materials, and even in siting'. Morton referred to 'several devices' that diminish the scale of the building and relate it to its surroundings:

First, it is placed to the rear and lowest part of the site where it also acts to define both the park and the campus. Then the structure is imbedded in the ground so that only four floors are visible from the front, where the four connected houses are expressed as eight separate, stepped units; each bedroom is articulated with a bay window that de-emphasizes the whole volume while repeating similar proportions to those of the older buildings. In addition, the shape of the building encourages a dialogue with the others nearby as its extended wings seem to reach out to them (Morton 1973).

Morton also claimed that the students are 'openly enthusiastic about the new dormitory', citing one student who said, 'it's uncanny how much this place reminds me of the old houses, and I don't know why'.



Figure 2.10 Mission Park Residential Houses, Williams College, 1972. Courtesy of The Architectural Archives, University of Pennsylvania. Ref: aap.267.144.13_a

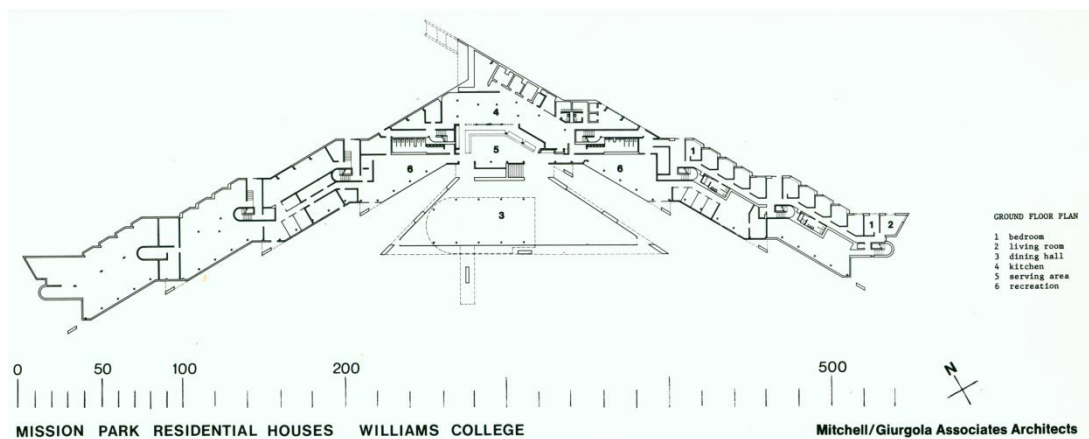

Figure 2.11 Mission Park Residential Houses, Williams College, 1972. Courtesy of The Architectural Archives, University of Pennsylvania. Ref: aap.015.V.133_a

The following year, in 1974, *Progressive Architecture* reported on ‘Two recent buildings’ by Mitchell/Giurgola. Critic Suzanne Stephens similarly concluded that although pairing the St Bede’s Worship Assembly building (1973) and Swarthmore Music College building (1973) ‘may seem haphazard’, the buildings are expressions of an approach that looks to the ‘specific situation’ (Stephens in (Chang & Architects, 1977)). She went on to explain that Giurgola’s approach was not an overt desire to relate the buildings to a context of forms, styles, and imagery. Rather, the two buildings accomplish site specificity through ‘site planning, building configuration, scale, and choice of materials’. At St Bede’s Stephens praised the relationship with

the existing nineteenth and twentieth century brick monastery buildings. 'At the same time', she comments, 'the building's placement and exterior treatment, which its sculptural light monitors, shifting planes, combination of highly polished reflective glass and textured brick assure the building's distinctiveness'. Conversely, she observed that the exterior form of the Swarthmore College music building is 'rather plain and straightforward'. And yet she found that the consideration of views to the surrounding landscape from the main music hall is equal to the spiritual space of St Bedes.



Figure 2.12 St Bedes Worship Assembly Building, 1973. Courtesy of The Architectural Archives, University of Pennsylvania. Ref: aaup 267.II.A.22b



Figure 2.13 Lang Music Building, Swarthmore College, 1973. Photograph by Rollin La France. Courtesy of The Architectural Archives, University of Pennsylvania. Ref: aaup.015.V.088.3

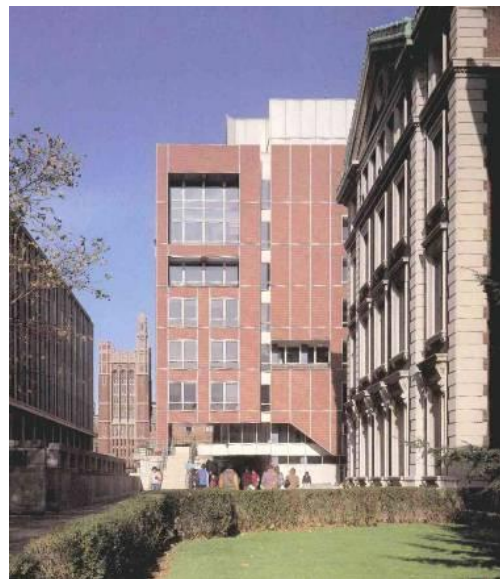

Figure 2.14 Life Sciences Building, Columbia University, 1977. Photograph by author, 2002

Chang conducted a more thorough review of Mitchell/Giurgola in 1977 (Chang & Architects). He made several observations: the brick-clad end walls of the University Parking Garage (1963), which repeat the colour and texture of the existing buildings

reflected the University's desire to make the building an 'appropriate addition to the neighbourhood'; the disposition and materiality of Giurgola's proposal for the AIA National Headquarters (1965) created the conditions in which the historic eighteenth Century Octagon House 'is allowed to enrich and become part of the present'; and the varying designs of the concrete screen façades for the Headquarters Building for the United Fund (1971) were designed according to their orientation. Similarly, Chang noted the Life Sciences Building (1977) is related to the surrounding Georgian buildings by its scale, fenestration and choice of a terracotta tile façade.

According to Phoebe Stanton, writing in the same publication, Mitchell/Giurgola's thinking and work could be distinguished from their predecessor Louis Kahn by their greater consideration for the 'world around them'. Conversely Kahn, although he resisted some earlier ideas of modernism, 'continued to think of the building as a form in space' (1977). Stanton identified the Lang Music Building (1973) and the Penn Mutual Tower (1975) as two examples of Mitchell/Giurgola work that in her opinion were elevated to a 'higher level' by the way in which they 'cooperate and are considerate of their larger environment'.

A growing awareness of site-specificity had crept into the modern movement earlier than Giurgola's time, with many leading practitioners of modernism introducing vernacular building methods and materials. In seeking to describe the work of R.M. Schindler, Michael Darling remarked that the American houses of Marcel Breuer, for instance, incorporated stone and sloping roofs as 'an attempt to integrate modernist sensibilities with East Coast tradition, guided by elegant abstraction' (Schindler et al., 2001). Darling described this as a superficial use of materials. Schindler's houses, on the other hand, displayed a deep-rooted concern for negotiating harmony between client and site. To elaborate, Darling provided further examples in the work of Le Corbusier, who used local materials 'to camouflage his machines for living', showing little concern with the actual conditions of the site and climate. On more than one occasion, Le Corbusier managed to create stunning sculptural statements, but failed miserably to create hospitable dwellings. Citing the historian Colin St. John Wilson, Darling concluded that Le Corbusier's house for Helene de Mandrot (1929—31):

illustrates an aspect of Le Corbusier's mind that was both its strength and its weakness: the attempt to raise every project to the level of a general issue of which it would then become a model demonstration' (St. John Wilson 1995, cited in (Schindler et al., 2001).

A feature of the reviews mentioned above was Giurgola's specific recognition of the surrounding context, be it neighbouring buildings, or a wooded college landscape. It is the specificity that reviewers claim distinguishes the work and explains the apparent stylistic inconsistency that some also observed. In a more recent review Architectural historian Sarah Williams Goldhagen (2001) argued that of Kahn's work and underlying philosophies conceptualised a 'situated person'. Kahn, she claimed, believed in a 'universal moral imperative' and that modern architects have a role to develop spaces that lead to self-awareness and awareness of those around them, thereby being more likely to consider the consequences of their actions. Goldhagen wrote:

In developing this belief he [Kahn] conjoined the political and social vision of early modernism with the philosophical-ethical paradigm drawn from Existentialism and an empirical analysis of the new social and cultural circumstances of the post-war period into a reframed notion of modern architecture dominated by the concept of the situated person, defined in both social and phenomenological terms (Goldhagen & Kahn, 2001).

While Kahn's concept of a universal moral undoubtedly was an influence on Giurgola – this is evidenced by his book on Kahn and the language of his own writing – Giurgola extended Kahn's concept to a *situated* building set within a landscape of what Giurgola referred to as 'fragments' of past occupation. This is also Stanton's insight mentioned earlier.

Robert Venturi, who is often mentioned alongside Giurgola in accounts from the 1970s, is also noted for practicing 'contextual architecture', of which his best-known example is the Venturi, Rauch and Scott Brown-designed Sainsbury Wing addition to the British National Gallery (1986—1991). In many ways the Sainsbury Wing is a

critique of Kahn's museums (Venturi 1991, cited in Hawkes 1996). Venturi and Scott Brown, akin to the Le Corbusier described by St John Wilson, elevated the specific project to the level of a demonstration of the 'mannerist' ideology they had adopted, re-deploying the ornament of the adjacent gallery exactly, but within a disorderly rhythm.

In Australia, Parliament House was noted by all reviewers for its formal connection at the macro scale to the geometry of the Griffin/Mahoney Canberra plan. The building's supporters also praised the building at a metaphysical level for allowing citizens to walk up and over the house, relating the experience to the expression of an egalitarian democracy (Spence, 1988).

Of the two religious buildings Giurgola realised in Australia, the St Patricks Cathedral received more attention. According to Jennifer Taylor, the relationship between the old and the new is 'one of the most elegant and coherent examples in modern architecture anywhere'. For Taylor the relationship is evident in the 'blending and poise of complementary opposites' (Taylor 2004). She reported that the 'complementary affiliation of the dissimilar' is achieved by a 'rapport of opposites' by the addition's juxtaposition of alignment, simple horizontal form, transference of rhythm and choice of materials. Giurgola himself acknowledges that he consciously used the proportions of the existing cathedral to develop the heights and length of the new cathedral space. He also made mention of the careful choice of materials, which he declared were intentionally opposed (2006). Of the lesser Charnwood church, Nigel Westbrook noted the connection between the existing and new buildings, mentioning alignment, but gave little attention to the theme (Westbrook, 1991).

The question remains at this point as to whether Giurgola was indeed a proponent of a post-modernism of wit, ornament, and double-coding as were some of the later assumptions about Parliament House; or whether the discussion around the parliament building has, to a degree, clouded Giurgola's contribution.

Learning from Alvar Aalto and the 'Nordic style'

Although again little mentioned in early accounts of the firm's work of the 1950s and 1960s, the influence 'Nordic style', particularly mention of the Finnish architect Alvar

Aalto, began to be mentioned in reviews of Mitchell/Giurgola buildings around the mid-1970s and continued through the 1980s. The first minor mention of Aalto occurs in Giurgola's writing on urban structures in 1954. However there can be few conclusions drawn from the influence at that early stage. As artistic director of the American *Interiors* magazine in the early 1950s, Giurgola would have been well versed in the Scandinavian furniture and design popular in the United States. Aalto's scheme for Helsinki is amongst an extensive list of projects that Giurgola praised as good models for urban development in his 1954 article.



Figure 2.15 An advertisement for imported Swedish furniture, typical of the 1950s, in *Interiors* (1953)

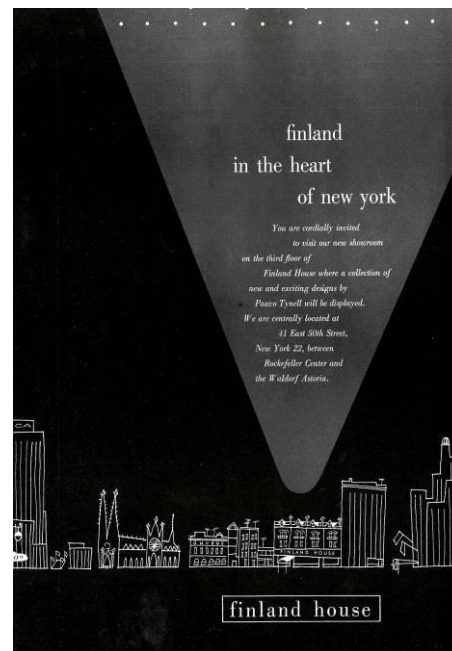

Figure 2.16 An advertisement announcing an opening for 'Finland House', typical of the 1950s, in *Interiors* (1953)

It was not until the death of Alvar Aalto in 1976 that Giurgola wrote that Aalto has had an influence on his thinking and design. *Progressive Architecture* published testimonials to Aalto in 1976, and invited contributions from Venturi, Giurgola, Gunnar Birkerts, George Baird, Ake T. Tjeder, Klaus Dunker, Nory Miller and Martin Price. Venturi wrote of his profound appreciation for Aalto, noting his admiration of Aalto's use of the free plan, choice of natural materials and contradictions by which Aalto articulated monumentality (Venturi, 1976). Giurgola's (1977) testimonial described a poetic memory of Aalto from his student years:

At the end of World War II, while it was yet impossible to perceive the immensity of destruction, a debate on the merits of rebuilding towns on new sites went on in Italy. Architects of the Bauhaus logic, aggressive as ever, generally favoured the construction of new places, down from the medieval hills into the valleys, close to rails, airports, and industries ... he [Aalto] suggested that if the only relic of a burned-down house was the brick chimney stack, that alone was a good reason to build again at the same place, piece by piece, mending the human fabric from those scattered fragments of life. For Alvar Aalto needed a sign to begin, his aspiration was toward a place, a new place with a tie to the past, however tragic' (Giurgola, 1977)

Despite this tribute, Giurgola did not mention Aalto when interviewed for the 1977 *Process: Architecture* monograph on the firm's work (Chang 1977). Mention of a Scandinavian antecedent is notably absent from the entire extensive review of the firm's work, aside from the final project in the monograph entitled 'Retreat House' and subtitled 'Northern European in Design'.

And yet, in Giurgola's writing following the death of Alvar Aalto, Aalto and Gunnar Asplund became counterpoints to Kahn's legacy. In 1981 Giurgola wrote of a visit to Stockholm from Italy in his formative years mentioned earlier, comparing what he saw as the synthesis between the old city and Asplund's library with that achieved in 'my Rome'. Two years later, Kenneth Frampton (1983) remarked that Giurgola found his late master, referring to Kahn, 'difficult to follow'. Although Frampton viewed Kahn as central to their work, he attributed the 'organic side of European Brutalism' typified by Aalto's House of Culture, and James Stirling's Leicester Engineering Laboratory as contributing to methods by which Mitchell/Giurgola had distanced themselves from Kahn. Frampton described the Tredyffrin Public Library (1976) and the Lukens Steel Company Administration Center (1979) as buildings that have roots in Scandinavia. The 'parti' of the Lukens building he attributed to Aalto and Asplund:

– to Aalto for the compositional device of ordering irregular masses against a straight line (as in Aalto's Leverkusen Cultural Centre

project of 1962) and to Asplund for the deployment of a series of free-standing orthogonal pavilions, running in front of a suppressed mass, as in the funerary chapel entrances to the Woodland Cemetery Crematorium, Stockholm, of 1940.

Clark and Pause's (1985) thematic study found similarities between the American work of Mitchell/Giurgola and the work of Aalto. Under the theme of 'mediation', they aligned the Tredyffrin Public Library (1976) with Aalto's Vouksenniska Church (1956–1958), writing that they share a progression between two conditions. At Tredyffrin, the mediation is between a point marked by a tree and the orthogonal built environment. In Aalto's church the design mediates between other buildings and the natural context of the woods. (See Figure 2.16) Clark and Pause also noted similarities in the 'geometric balance' in both buildings.

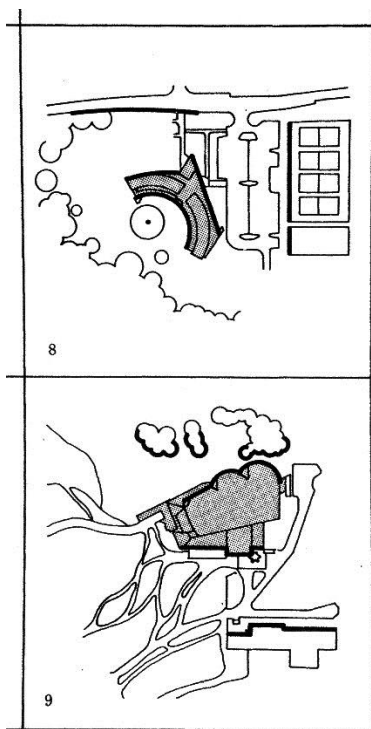

Figure 2.17: Detail of Clark and Pause's analysis. Source: Clark and Pause (1985)

Despite Giurgola's assertions in the 1970s and 1980s about the importance of Aalto and Asplund, mention of this influence in Giurgola's work in Australia are almost absent. The mono-pitch roof of the St Thomas Church, that is, according to Westbrook, 'reminiscent of Aalto's late work' (Westbrook 1991) is the only mention.

No reference of a Scandinavian/Nordic influence is made in literature for Parliament House, St Patricks, or the Lake Bathurst House.

It has recently been argued that in many of Aalto's works, a single room is designed to carry the essential architectural idea (Anderson 2011), quite similar to the notion of a 'room' more explicitly described by Louis Kahn. Kahn is said to have criticized Aalto's work saying that a building composed of designed responses to casual activity would be a monument to casualness. The antecedent of Aalto and Asplund for Giurgola, who is often portrayed as one of the closest adherents to Kahn's ideas, deserves greater attention. How Giurgola manages to navigate between the two is an intriguing, and understudied aspect of his work.

Working methods

In the publication of the first retrospective review of the firm's work in 1977, reviewers begin to question how the office of Mitchell/Giurgola went about their work. Giurgola's partner, Ehrman Mitchell, reported on the operation of the firm, stating that although the firm had two geographic locations: New York and Philadelphia, Mitchell/Giurgola was one entity. He described the assignment of a new project to a partner or associate of the firm who will lead the selection of teams and deliver a project from beginning to end. 'That which they design and detail they must also build', he stated. Mitchell drew a picture of the working environment in which each member of the office 'contributes to the whole' (Chang & Architects, 1977).

In the same publication, Giurgola was interviewed. In speaking about how Mitchell/Giurgola was formed, Giurgola commented on the expansion of the firm from 'doing everything ourselves' in 1958 to a larger office. He remarked that in his view it was important for people to have his reassurance in their work.

So I make a point of spending time in each group. I will try to work things out with everyone around, so everyone is concerned about that detail or that site place; they know all the time what is going on in the building. I do that with the client also. Sometimes, in the middle, I get almost everybody there, and many times, the client

*won't like that. He'll say, 'Well, there are too many people around',
but I like that (Chang & Architects, 1977)*

When questioned directly on the first thing that he would do when he began to design, Giurgola described a process internal to the office as the first step:

I think first we come up with what will be the team that will do the project. We set up a table to do the work. And then we discuss the nature of the project.

The second step was external to the office, spending time on the site. 'Sometimes two or three days, not to do anything special', he commented, 'We want to assimilate atmosphere and character'. He described this experience as being of greater value than an encounter with other sites of a similar nature. 'A wonderful trip and we enjoyed it', he remarked about a tour of dormitories in Europe before designing housing for Yale University, but stated that instead, 'I wanted to stay at Yale as much as possible, see the students, what they are doing'.

Reviews of the firm's work in the 1977 monograph by the various critics did not look too deeply at its internal processes, instead concentrating on the built product. It was not until Parliament House that greater insight was given into Giurgola's way of working. It was those who worked closest with Giurgola at the 2000 Symposium who noted his 'inclusive approach', particularly the artists and craftspeople who had worked with Giurgola on the parliament project. They praised Giurgola for an intense interest in collaborating with artists in his building designs (Berg, 2000). Pam Berg connected 'Giurgola's natural working method... of working 'side-by-side'' with young architects and staff with his belief that art and architecture carry a 'resonance' through 'memories, fragments, and intentional visual references'. She noted Giurgola's early involvement of artists in the making of the firm's corporate and public buildings, pointing particularly to the Volvo Headquarters. Artist Helge Larson praised Giurgola's 'Collaborative Effort', remarking on his surprise at the intense interest in his work for the suspended light fitting at the entrance to the House of Representatives (Larson, 2000). Mandy Martin claimed that Giurgola knew how artists think, and 'indeed thinks like an artist himself' (Martin, 2000). It is clear that

those who worked closely with Giurgola developed a deep affection for the man and his collaborative way of working.

The later symposium in 2012 focused less on this theme, apart from architect Robert Thorne, who discussed his observations from working with Giurgola on the St Thomas and St Patricks buildings.

Discussion

The majority of published articles about Mitchell/Giurgola and the firm's work during the 1960s and early 1970s are special photographic features contemporary with the construction of their major buildings. Other than demonstrating the considerable amount of media attention that Mitchell/Giurgola received during that time, these articles provide little more than images and some construction details of several of the firm's major projects, with very little text and no real contemporary criticism. However, by the late 1970s, in broader retrospective reviews across a body of their work, greater focus was given to the underlying philosophy of the firm.

Overwhelmingly Giurgola was linked to the discussions of urban planning and architecture that occurred on the East Coast of America in the 1960s-1970s with Venturi and Kahn. Other groups with which Giurgola was associated were variously described as the 'third generation', 'inclusives', and 'grays' in the gray vs white opposition with the New York Five. A common thread among these groups was seen as a greater concern for the role architecture plays in building up the character of urban places; the environments in which people undertake their daily lives, and which speak to them about the community in which they live.

Whereas it is accepted by critics that Giurgola was a disciple of Kahn, it is noted (although a little studied aspect of the firm's work) that Mitchell/Giurgola distanced their work from Kahn. According to some commentators, Giurgola's buildings displayed an otherness related to how they responded to the specific nature of their location. It is an aspect of Giurgola's work that deserves closer attention. There is also scant study of Giurgola's work after Parliament House and no comprehensive assessment of the Australian body of work that may yield new insights into our

understanding of the parliament building, and the contribution of Giurgola, an important and yet understudied architect of the recent past, to Australian architecture.

Chapter 3 Method

Introduction

Giurgola's passage from his birthplace in Italy to his arrival and emergence in the United States, and later encounter with Australia, is a rich tapestry of architectural practice that touches on many of the major themes of the second half of the twentieth century. The early development of this project began with observations during the period I was employed at Mitchell/Giurgola & Thorp Architects in Canberra. I was intrigued that Giurgola, when discussing a project, referred as much to the work of Alvar Aalto or Gunnar Asplund as he did to the work of Louis Kahn. This was unexpected as I knew Mitchell/Giurgola for their association with Kahn in the United States, and later in Australia, through the discussion around the parliament building, but not the connection with Aalto or other north European architects.

To expand knowledge of the work of the firm, the most direct source of primary evidence available was talking with Giurgola; and in addition, exploring the firm's archival drawings, and visiting the Australian buildings themselves. However, even though the observations of a participant observer is a legitimate architectural research method (Groat & Wang, 2002):180, and allowed me insights into Giurgola's way of working, I was an active participant in the work in the initial phases of research, not objective observer. This was a transition that occurred as I exited the office. Also, my experience of working directly with him was limited to the one project, which, while it offers a valuable snap-shot of his late career, more could be gained from expanding the study to other Australian buildings.

Other ways of looking at Giurgola's work were also explored, initially focused on the single case study of the St Thomas Aquinas Church; it being the most recognizable example of a Scandinavian influence, particular that of Alvar Aalto. It was also a project that was confounding; as to how Giurgola moved from the enormity of the parliament building to a small church in the Canberra suburbs, and that the building had such a strong formal relationship to Aalto's Maison Louis Carré. Giurgola's personal contact with Aalto was limited to a couple of visits when traveling to Finland, and his memory of Aalto's presence in Italy during his architectural training.

It was not the meaningful exchange he had in the conversations with Kahn and Venturi on the east coast of America in the 1950s to 1970s. Therefore his admiration of Aalto, amongst other Scandinavian architects was apparently from a distance. Although, in working and speaking with Giurgola, I learnt that the admiration went deeper than an appropriation of formal aspects of Nordic modernism to the underlying concerns with values of landscape, context and human experience.

To further understand the lessons from Aalto's architecture, I looked to several studies that took a formal analysis method to ask how do we 'know' Aalto's buildings? Studies by Griffiths (1997), Radford and Oksala (Radford & Oksala, 2006) and Duany (1986) proved to be useful lenses. For instance, Bell's (1979), and later, Radford and Oksala's paradigm of 'discontinuity' is of particular bearing as I later contend that the indistinctness in Giurgola's architecture is deliberately calculated. Further, that it is a common pattern that binds Giurgola to the practical art of architecture described in St John Wilson's other tradition; despite the 'variety' noted in Giurgola's past work (Stanton 1977, Frampton 1983) that swings from the concrete brutalism of the School of Law at the University of Washington to delicate infill like the Subway Concourse Entrance to the comprehensive urban schemes like the Australian Parliament, or his United States Capitol Master Plan.

The formal analysis tool has been used for study of other architects of Giurgola's generation. For example, Lyndon Johnson's study (1986) of Charles Moore uses diagrams to discuss the influence of Kahn and Aalto in his work of the 1960s. Johnson compares Moore's Jobson House (1961) with the Johnson House at Sea Ranch (1965) designed with William Turnbull a few years later, both variations on the theme of geometric shapes enclosed by a square. In the Jobson house it is a square within a square, whereas in the Johnson house, it is an octagon enclosed in the square. The rigid geometry of the plan is then adjusted by the addition of 'saddlebags' which contain service areas. Both houses are covered by a pyramidal shaped roof centred over the central square or octagon which is cut to the shape of the plan. Johnson comments that while the plan is additive, the roof is subtractive. He concludes that in these houses Moore, 'fused the work of Alvar Aalto and Louis Kahn', referring to Aalto's Villa Carré and Kahn's Trenton Bathhouse. By use of diagrams, Johnson was

able to demonstrate the consistency of design tactics developed in the design of the two houses, such as the octagon in the square, which flowed through to his later work.

Thus, I began working with the formal analysis tool to broaden my understanding of the St Thomas Church and how the formal devices employed may relate to earlier buildings. Whilst undertaking this study of the formal aspects of the work itself, I interviewed Giurgola's colleagues and clients to understand more about the context in which the work was created. The information gained from the interviews in turn informed the formal study, and conversely insights gained from interviews pointed to aspects of the buildings for further analysis.

In summary, the tactical procedure had the following parts:

1. A study of the literature about the firm of Mitchell/Giurgola and Mitchell/Giurgola & Thorp;
2. Interviews with Giurgola;
3. Interviews with architects who worked with Giurgola on projects in Australia and America;
4. Interviews with Australian clients;
5. A study of documentary evidence in the form of sketches, works of art, documents and office records; and
6. Formal analysis of selected case study Australian buildings.

Hence, I have divided the method discussion into two sections. The first section looks at the traditional strategies of a constructed narrative. It begins with a description of my personal experience as an architect in the office of Mitchell/Giurgola and Thorp from 2000 until 2003. A subsection describes the series of interviews undertaken from 2002 to 2007.

The second section of this chapter looks at formal analysis methods, particularly the role of the diagram by its potential to bring out underlying ideas present in the object of production. The section also introduces case study as a relevant paradigm to look at Giurgola's encounter with Australia, as well as describing the rationale for the

selection of four of the Australian buildings. It includes a short discussion on a method and an ethical theoretical position that is of interest to the study. Warwick Fox's theory of responsive cohesion to architecture, and how this may connect with formal analysis.

Historical-Interpretative Process

Participant Observation

I was employed in the office of MGT Architects, Canberra (formerly Mitchell/Giurgola & Thorp Architects) from 2000 until 2003. The partners were Tim Halden Brown (Canberra), Richard Thorp (Sydney), Hal Guida (Canberra), Pamille Berg (Canberra), Steve Moseley (Canberra), and Richard Francis Jones (Sydney). Although officially retired from the practice in 1999, Aldo¹³ remained a strong presence. He kept a drawing board on the studio floor and an office from where he consulted on various art programmes and collaborated with MGT Architects on the St Patrick's Cathedral project for which he held full design direction. MGT Architects supplied administration, project management, and junior staff. The experience in the office and working directly with Aldo has contributed greatly to my understanding of the way in which he undertakes design tasks and works with others.

The cathedral was in the documentation phase when I entered the project. I was given the task of completing design and documentation of the internal details and furniture and worked in collaboration with artists of the art programme run by Partner, Pamille Berg and industrial designer Jon Burchill. This was Aldo's favourite way of working - to foster interaction between diverse opinions and backgrounds. In addition, Aldo regularly sought out and encouraged input from the youngest members of the team.

What became immediately apparent amongst the long-standing employees of the firm, and those especially close to Aldo, was a sensibility to Scandinavian architecture and design. Hal Guida recalls that in the late 1970's Giurgola brought a copy of Architectural Review featuring the Bagsværd Chapel to show him on one of his trips

¹³ Romaldo Giurgola is affectionately known as 'Aldo'.

to Philadelphia (H. Guida, 2007). Utzon's Bagsværd Chapel and Giurgola's St Thomas Church often featured in discussions on the Cathedral project and were clear antecedents for the Cathedral in their art and technique. Furthermore, the same artists from the St Thomas Church and Parliament projects were sought for commissions in the artwork for St Patrick's.

I did not start working immediately with Aldo but over time had more interaction with him over a couple of small projects. He appeared to be the happiest working with the younger people in the office. He frequently invited us to his board to look at what he was working on, and demanded our criticism. In 2001, I began working full time with Aldo on the cathedral project for Parramatta. The project had been in the office since 1998 and was entering the design development phase. The architectural project team consisted of Aldo (design architect), Bob Thorne (project architect), Cassandra Keller (architect), and myself. Partner Pam Berg (Art Program) was also integral to the project and attended all meetings with Aldo. Others came and went from the project as demand required.

The Parramatta cathedral project linked me to Aldo for eighteen months until the final stages of its documentation. MGT Architects relocated office to Fyshwick around this time - an outer semi-industrial suburb of Canberra. When my role finished with the Cathedral in 2002, I was moved to the design of a Primary School in Adelaide under the direction of Partner, Harold Guida, who had 'grown up' in the firm. He joined the office of Mitchell/Giurgola in 1968 as a fresh graduate from California and was one of the architects who moved to Australia with the parliament project, later, like Aldo, electing to permanently relocate to Canberra. The work of Alvar Aalto, also for Hal, was a constant reference and the first sketch design proposals for the school, included precedent studies of Aalto's Säynätsalo Town Hall.

In 2000 a symposium was held in Sydney to celebrate Aldo's 80th birthday. It was convened by the University of New South Wales. I had known a little of Aldo's work before the parliament building and it was at the symposium that the depth of his work was revealed to me. Additionally, I became aware of the academic interest in his work.

The enquiry for this study began as a series of recorded conversations with Aldo discussing Aalto's influence in 2002. From this point I began to see the work of MGT Architects in Australia through the eyes of our conversations.

In 2003 the MGT Architects partnership was dissolved and I left the firm. The Sydney office was restructured as Francis-Jones Morehan Thorp, and the Canberra office as Guida Moseley Brown Architects. At the same time I discussed with Aldo the possibility of a research project about the influence of Alvar Aalto on his work – something that I had observed during my time in the firm. Aldo encouraged the project. With encouragement and assistance from Aldo, I was prompted to travel to Finland in order to visit the works of Alvar Aalto, and to live and work for one year from 2003 until 2004. This led to a first project at a Masters level which was later upgraded to the current Doctorate project in 2007.

The following table details my contribution to and visitation of buildings.

Building	Contribution	Period employed on the project	Dates visited
Sherman Fairchild Center for the Life Sciences, Columbia University	Nil	-	2004
St Thomas Aquinas, Charnwood	Nil	-	2002 2007
Red Centre, University of New South Wales	Nil	-	2000

Science and Mathematical Sciences buildings, University of Adelaide	Nil	-	2002 2010
Scientia Building	Nil	-	2000
St Patricks Cathedral, Parramatta	Detailed design, model construction and contract documentation	2001—2002	2004 2007
Mawson Lakes Primary School, Adelaide	Concept design, detailed design and contract documentation	2002—2003	2004
Mawson Centre, Mawson Lakes	Concept design	2003	2004
RG House, Lake Bathurst	Model construction	2002	2002 2004 2007

Conversations and interviews

A series of interviews were arranged with Giurgola and those who had worked with him over a longer period of time. The strength of these interviews lies in their ability to uncover previously unknown material, but more importantly, they generate discussion about the relationships Giurgola held during his career and bring out a better understanding of his personal and collective identity (Thomson, 2006). Over his career he belonged to professional, collegiate, and familial groups which influenced, informed and reinforced certain memories while downplaying others. The interviews

allowed me to compare his views with those of his colleagues and clients. They also allowed the triangulation of events in historical timelines against documentary evidence.

Interviews were conducted in two sessions related to the two stages of research and were as follows:-

2002

Conversations regarding the Master research topic (Aalto). The conversations were held in a relaxed format, over lunch with open ended questions. They were taped using an analogue tape recorder and transcribed by the author. The draft transcriptions were provided to Aldo. His notation and clarifications were incorporated into the final transcripts.

Interview with the parish priest, Father Drinkwater, of St Thomas Aquinas Church, Canberra.

Interview with Robert Thorne, Project Architect for St Thomas Aquinas Church.

2007-10

The second round of interviews reflects the broader subject matter related to the PhD proposal and included other members of the MGT Architects office and clients.

The interviews with Aldo were taken over three days. Questions were sent in advance of the meetings. A first interview was taken in his office and the second interview in his home on the following day. Some clarifying questions were added on the third day. Consideration was given to Aldo's age (87 at the time). Therefore the interviews were limited to one hour per session, longer only if it was felt that Aldo would like to complete a narration.

Others that were interviewed in the same visit included those who had followed Aldo from the United States, known and worked with him for a long period of time and former clients. They are as follows:-

Pam Berg, former partner of MGT Canberra, and former employee of Mitchell/Giurgola in the Philadelphia and New York offices. Interview held in Pam's office, Canberra, 10 September 2007.

Harold (Hal) Guida, partner of Guida Moseley Brown Architects, former partner of MGT Canberra, and former employee of Mitchell/Giurgola in the Philadelphia office. Interview held in MGT Architects office, Canberra 10 September 2007. Hal also provided written feedback to various drafts of this thesis in 2014.

Douglas Brooks, Associate of MGT Canberra, employee (1982-2002). Interview by telephone 2007.

Rollin R. La France, former associate and partner of Mitchell/Giurgola and Thorp, Canberra, and former employee of Mitchell/Giurgola. In 1980 La France undertook a study tour to Finland of Aalto buildings. Interview was by E-mail correspondence in 2014.

Pehr G. Gyllenhammar, CEO and chairman of Volvo from 1970 until 1994. Gyllenhammar oversaw the Volvo Headquarters building (1984) and formed a friendship with Giurgola during their work together. The interview was held over the telephone in 2010.

Bishop Kevin M. Manning, former Bishop of the Diocese of Parramatta, client of Parramatta Cathedral. The interview was held over the telephone in 2010.

Father Peter Williams, member of the Art Advisory Committee for the Parramatta Cathedral. The interview was held in Adelaide during a visit by Father Williams in 2010.

All interviews were taped using a digital recorder and transcribed by the author. For Berg and Guida, draft transcripts were returned to and their comments were incorporated into the final transcripts.

The method varied slightly with the client interviewees in that they were not provided with a draft transcript for comment.

Formal Analysis

As Baker (Baker, 1989) explains, the formal analytical methodology seeks to discover the primary organisational factors and generic forms which operate in a building, and in doing so to reveal the pre-occupations of the designer, regardless, one must add, of whether the designer was aware of them, or not . Formal analysis operates by breaking the building down into fragments and discussing the relationship between these fragments. The form can then be analysed in reference to the purpose which the building was intended to serve, and to the kind of symbolic imagery which the building expresses.

Formalism, on which the formal analysis method is based, is understood to be rooted in German idealist criticism from the turn of the century, that of Heinrich Wolffin and Paul Frankl, according to whom the truth embodied in a building is in its form, and its meaning, although produced at a particular time, remains universal and accessible (Griffiths, 1997): 13. Formal analysis is understood to be linked to structuralism and the discovery that underlying structural similarities which recur from one 'text' to another, irrespective of apparent differences in the work. A criticism therefore of structuralism, as a mode of study, is that the object is removed from its context and that it takes systems of human reality as universal ones (Groat & Wang, 2002). Still, interpretation and meaning are context dependent, particularly so in the case of an architect such as Giurgola who was inspired by the reality of Parramatta in designing the St Patricks Cathedral.

The working tool of formal analysis is the diagram. Graf (1986a) writes that the reductive analysis of an object to information (words) results in a loss, removing it from the firm position of artefact to the more uncertain territory of artifice. In his outline of a formal method, Graf contends that it is not possible to fully 'know' a building. As the object of analysis, the building is reduced to information; information is reduced to invention, and invention to interpretation. 'The process wrests the building from the tangible world of the specific, complete but unclear, and deposits it as fragments, clear but incomplete, in the intangible world of the general, a world in which genera become central.' (Graf, 1986b p.42). Instead, the diagram, Graf argues, 'is the intermediary; it loosens rather than loses, developing its attributes from both

aspects of opposing dualisms and thus presenting rather than representing, explaining rather than embodying. The diagram, then, can be a simultaneous discussion of the thing itself and what it manifests' (Graf, 1986b p.43). It is a process of relating elements and configurations to the human experience. An awareness, that 'she or he is somewhere; she or he has a means of going somewhere; and thirdly, that there is somewhere to go.'

Graf (1986a), describes operational elements of the Pythagorean series to define the elements and their configurations: centre, perimeter, intersection, and module, explaining that the juxtaposition of elements establishes a relationship of equivalence or difference (See Figure 3.1). In a study of Aalto's Enzo-Gutzeit building in Helsinki, Griffiths (1997) terms these predispositions as 'Place', 'Projection', and 'Limit'. However, as Griffiths emphasises in his study, it is not only the internal relationship between fragments of form which give rise to interpretation and meanings, but that the context is also one element.

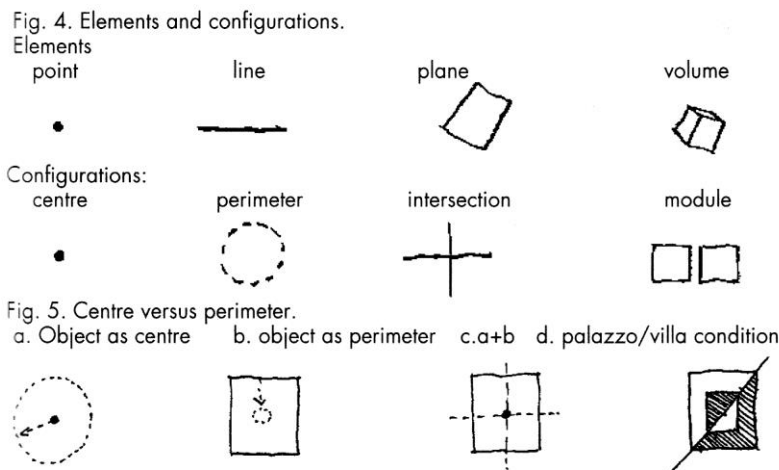

Figure 3.1: Element and configuration diagrams from Griffiths (1997).

In studying Aalto's work, Griffiths goes on to detail the usefulness of the figure/ground diagram to open interpretations of form within a context, specifically the *Palazzo* condition of Frankl's studies of Roman villas (1968). Griffiths defines this configuration as demonstrating 'an anxiety of presence or absence or mutually referential whole...the anxiety being shown at the point of reverse figure-ground in the *Gestalt* double image interface'. This is central to Griffiths' study of the Enso-

Gutzeit building as a palazzo and his proposal that Aalto used a strategy to create anxiety in his compositions to consciously engage in a formal discussion with the surrounding physical context. The example that Griffiths offers is his brief analysis of Aalto's MIT Baker House Dormitories (1947-48) where he describes its palazzo condition diagrammatically:

One can note that the curve of the building supposedly acknowledges the bend of the adjacent river (Fig. 13ii), but that the pavilionised common room block becomes an object centre around which the motif becomes rediscussed (Fig. 13iii). The river is a continuous 'bar', and the building reproduces this – the bar could be extended much further (fig. 13i). But the common room pavilion holds this in check. Of course, if there had been another pavilion within the second curve this would have continued the extendible bar motif (Fig. 13iv); and, indeed, there is a second pavilion on the other side of the lobby, but it does not contain the same arguments as the common room pavilion – it is more like a fragment which has broken free (Fig. 13v). With the façade which faces the river being interrupted as the main 'representative' façade (Fig. 13vi), this introduces a difference of hierarchy across the axis of the bar (Fig. 13v). So, the ends of the bar can then be joined in a palazzo motif (Fig. 13vii). But then how would one reconcile this with the pavilion? The pavilion can be reconfigured as the cortile – after all, there is an open well at the centre of the pavilion, i.e. a certain centre (Fig. 13viii). What we have, again, is the axis of anxiety between the palazzo and the villa motifs (Fig ix).

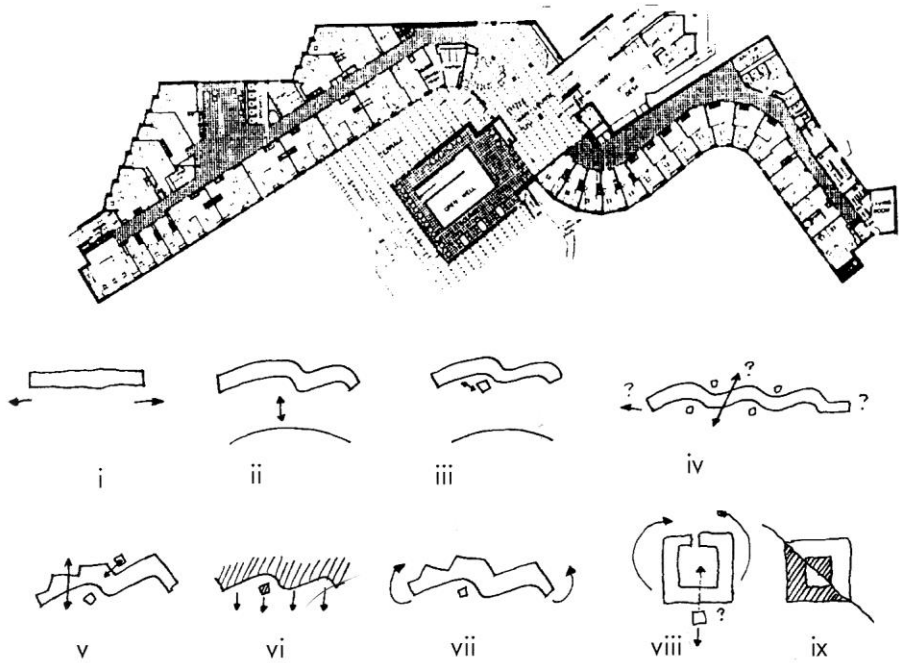

Fig. 12. Aalto's MIT Baker House Dormitories (1947-48), plan;
 Fig. 13. (i-ix). Formal analysis of the building, showing diagrammatic representations of bar, and palazzo/villa themes.

Figure 3.2: Diagrams explaining formal analysis of Aalto's MIT Baker House Dormitories from Griffiths (1997)

To anticipate a later discussion in this thesis, the description of the palazzo condition informs the study of Giurgola's buildings. For example, in the parliament building the odd change of scale between the flag pole and parliament chamber roofs, against the backdrop of the covering lawn, which I will argue Giurgola used to deliberately confuse. It is also relevant to the use of double-coding following from Robert Venturi. Venturi's Vanna House is an example, which by its deceptive simplicity but distorted symmetry, aims to create a condition in which the building is read as 'both/and'. Venturi consciously creates a point of anxiety at which the building's contextual reality is brought into question.

Another useful way of looking at the relationships between complex sets of contexts is the more recent work in the philosophy of ethics by Warwick Fox (2006). In his book, *A Theory of General Ethics: Human Relationships, Nature and the Built Environment*, Fox argues that 'conventional' environmental ethics is wrong to not include the built environment. Fox writes that the built environment is 'the most obvious and prominent form of our human-constructed world — the one that

structures most of people's day-to-day lives in space and time more than any other kinds of human artefacts...?'

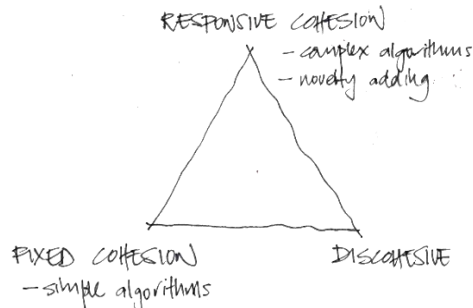

Figure 3.3: Sketch of Fox's three possible relationships between things. Taken during a lecture by Fox at University of Adelaide 11/11/2012

On the other hand, things have *discohesion* when they 'lack a clinging or adhering together' or are 'chaotic or anarchic'. At a third point lies *fixed cohesion*, a form of cohesion that is characterized by minimal modifying interaction between its salient features, by having elements that are forced into place, or by screening out a whole range of salient features from the situation being considered.

As design theorist Antony Radford (2010) explains, in relating Fox's concept to architecture, responsive cohesion is a state or relationship,

...in which a 'thing' (creature, community, building) or process (learning, play, design) exhibits mutually beneficial interactions between itself and its contexts, and also between its internal components. This contrasts with domination by one factor (fixed cohesion) or anarchy (discohesion) (Radford, 2010).

Fox provides pertinent examples to explain his concept of responsive cohesion. The simplest of these is a conversation between two people. A conversation that displays responsive cohesion, and is therefore valuable, is one in which each party has equal share of speaking and listening, and the conversation is coherent to both participants. By contrast, a poor conversation will either be dominated by one participant (fixed cohesion) or the participants, although having equal share of the conversation, speak 'past' each other, neither comprehending the other (discohesion). In the larger sphere

of human relations Fox relates that the responsive cohesive, and therefore ‘best’ system of governance, is democracy. Neither a dictatorship (fixed cohesion) nor anarchy (discohesion) is desirable.

In the physical realm of architecture, understanding the relationship between salient visual features (forms) is the ‘glue’ which defines their coherence. This could be seen in terms as the internal world of the building set within the wider world, that of the street, neighbourhood and city. The recent disagreement surrounding the construction of London’s 95 storey ‘Shard of Glass’ designed by the architect Renzo Piano is an example of the types of value questions that architects face in the design of significant change to the established pattern of development that makes up an historic city. Comparing the London Shard intervention with Giurgola’s design for an extension to Louis Kahn’s Kimbell Museum, Giurgola’s 1989 proposal to imitate its iconic concrete vaulted roofs was strongly criticised for not differentiating enough from the original design. The episode is discussed in further detail later but the comparison demonstrates that values are attributed to existing systems whether they are historic cities or iconic works of architecture. A successful addition, in Fox’s terms, would seek to provide a mutual benefit; that is, the sum of the parts is greater than the value of individual pieces. For example, are the values of the historic city increased by the insertion of such a dramatically contrasting element? In Giurgola’s addition to the Kimbell Museum, are the values degraded or enhanced by imitation of existing forms? Giurgola argued that he was being faithful to Kahn’s original plans for a larger building.



Figure 3.4: A model of Giurgola’s proposed extension to the Kimbell Museum

Several objections have been raised against the assertion that responsive cohesion is the foundational value in ethics , (Brennan, 2007; J. H. Brown, 2008; Stephens, 2008). Some of these relate to a misunderstanding of Fox's assertion while others expect too much from the concept, anticipating that values may be measured in some way. Irrespective of the merits of these objections, Fox's practical concept of mutually supportive systems (or contexts) is useful to conceptualise the field of contexts in which a design problem sits – a facet that brings a broader view of sets of contexts, such as collective desires, to St John Wilson's other tradition.

Case Study Selection

Although Giurgola remained active in the architectural output of Mitchell/Giurgola and Thorp, as established in Canberra from 1988 until 2000, and Mitchell/Giurgola (New York & Philadelphia), following the Australian Parliament he progressively focused on the few Australian buildings. Giurgola's collaborative approach to a design task was a feature of his career, sometimes allowing for the emergence of strong contributors. For instance, the Scientia Building at the University of New South Wales is widely credited to both Giurgola and his younger associate Richard Francis-Jones, some giving greater credit to Francis-Jones. Similarly buildings at the University of Adelaide, New Molecular Life Sciences Building and New Mathematics & Engineering Building (1995-2000) were executed in association with a local Adelaide firm of Hardy Milazzo. The selection of buildings for further investigation in this study was weighted to those in which Giurgola was the central actor. The benefit of selecting a few case studies also opens several simultaneous methods of interpretation through which to consider Giurgola's wider body of work (Groat & Wang, 2002).

The selected buildings are Parliament House (1981-88), St Thomas Aquinas Church (1989), St Patrick's Cathedral (1998-2004), and the house he designed for himself at Lake Bathurst (2002). Giurgola's St Thomas Church is given special attention in this study intersects a multitude of contextual factors – from Giurgola's arrival in Australia, the physical landscape including the overlay of the Mahoney and Griffin Canberra plan, the history of planning of communities in Canberra, to the much broader socio-political and architectural contexts, such as the theological principles

set out by the Second Vatican Council. Parliament House, on the other hand, is treated in a slightly different way than the other buildings, with less focus on the formal analysis and greater focus on its historical narrative. Like Giurgola's introduction to Australia, Parliament House is used to establish the circumstance of his arrival, and set the background for his further contribution.

Discussion

In looking at an appropriate method to study Giurgola's work, a number of qualitative methods have been explored. The initial resources were the author's personal experience of working with Giurgola, the oral history of the subject, his sketches and other documents in the traditional historical interpretative mode. The examination of these sources alone has the potential to expand our knowledge of an important Australian architect, and provide new insights into Giurgola's journey that have previously been overlooked. However, to further exploit the opportunities presented by his design output, other methods, including formal analysis were utilised.

The advantage of using a 'cosmopolitan research strategy' (Brewer & Hunter, 1989) is in the triangulation of methods. My personal experience of working with Giurgola has contributed to my understanding of his idiosyncrasies and his way of working with others, although at the time I was not actively engaged in research. Still, I was observant because I wanted to learn from Aldo, whom I admired, not only as a talented and experienced architect, but for his humility and generosity. Later, through the interviews with Giurgola and others around him, I was able to learn more about the context that brought him to Australia, and his reasons for staying here when he could have returned to an established business in the United States, where he was better known.

On the other hand, the addition of the formal analysis and case study method allows a critical distance from the subject. An examination of each of the individual case study buildings has the potential to draw out recurring and unexpected themes which complement and contrast the narrative study, and allows for the material arising from interviews to be reassessed. In turn the formal analysis acted as a spur for what has been left out of the interview process. This study juxtaposes the formal analysis with

Giurgola's recollections of the design process and unpublished material – sketches and drawings – from the Mitchell/Giurgola and Thorp archives. In doing so, it endeavours to understand the connections between Giurgola's design output and other forms of modernism.

Chapter 4 New Parliament House (1979-1988)



Figure 4.1 New Parliament House, Canberra. Photograph by Max Jefferies.

On May 9, 1988 Australia's New Parliament House was opened by Queen Elizabeth II, replacing an earlier, and much loved, temporary building further downslope, towards Lake Burley Griffin. The opening date was designed to coincide with celebrations of the bicentennial year of European settlement in Australia. The building consisted of accommodation for the two houses of the Australian Parliament, their supporting offices and facilities, committee rooms, offices for the parliamentary media, and a great public hall. Spread across a 32 acre site and at a cost of \$AUS1.1 billion it stood as one of the greatest government structures of the second half of the 20th Century.

In her opening address, the Queen noted the building's relationship to the Griffin/Mahoney Canberra plan¹⁴ and the impression of finality that the Mitchell

¹⁴ Even though modified from its original scheme, Walter Burley Griffin's 1912 competition winning design for Australia's capital city is the basis on which Canberra has been developed. The competition

Giurgola & Thorp design, selected 8 years earlier from an open, two stage competition, brought to the Federal Capital:

The completion of this splendid building has put the finishing touch to Walter Burley Griffin's grand design chosen by the Australian Government seventy-six years ago. It is as if all the other buildings of the great national institutions had been waiting for this, the greatest of them all, to take its rightful place as their centre and focus.

This is a special occasion for the Parliament, but it is also a very important day for all the people of Australia. After eighty-seven years of Federation, a permanent home has been provided for Parliament, which is both the living expression of that Federation and the embodiment of the democratic principles of freedom, equality and justice.

The cleverness of the Mitchell/Giurgola & Thorp design was in its merging of the building with site's topography. This appeared to resolve the unease about the selection of Capitol Hill which was not the originally intended location in the Griffin/Mahoney plan for the parliament building¹⁵. In its deployment, the Mitchell/Giurgola & Thorp design was strongly symmetrical, relating in an easily interpreted rapport with the established axial geometry in the Canberra plan. The assessors' report on the winning scheme noted its simplicity and accessibility where

entry was submitted in Walter's name, however the plan was formulated in collaboration with Marion Mahony Griffin.

¹⁵ Griffin and Mahoney used the land formations around Canberra as the basis for their plan for the city and to define symbolic axes. Capitol Hill was not the intended site for the Parliament. Instead, Griffin had selected a butte downslope for the houses of Parliament, reserving Capitol Hill for a large ceremonial building. For an in-depth study of Canberra's development, refer *Canberra following Griffin: A Design History of Australia's National Capital* (Reid 2002).

children ‘will not only be able to climb on the building but draw it easily too’ (Parliament House 1980)¹⁶.

In explaining how the design was supposed to be read, and his intention to align the building with the progressive principles of the Griffins, Giurgola stated:

The site of the new Parliament House is at a vital point of confluence which completes the geometry of the plan of Canberra. As conceived by Walter Burley Griffin in 1912, the plan is one of intense order which at the same time preserves a pliable and enfolding landscape.

Within the context of the new Parliament House, with its balanced and unforgettable geometry, forms an intimate relationship with the topography and the colour spectrum of the surrounding vegetation, rather than being an imposing and dominating presence on the Hill.

Through the welcoming gestures of its forms, the building implies direct connections with a long cultural tradition which we have all implicitly made by living in a democratic society as individual parts of a whole (Giurgola 1988).

In profile, it is a flat building, of no more than three stories. The first (ground) and third levels are restricted government areas. Sandwiched between them is the public level. Great arcing granite clad walls, each 460m in length, hold back the earth on two sides. From the corners, four grassy lawns run up to an open summit over which ascends a giant spidery supported flagpole as the centrepiece of the composition.

In plan, the curving walls neatly slice the hill into four discernable sectors, aligned to the main functions of the building: the two houses of government, north-west and south-east; public entry and the executive of government, north-east and south-west

¹⁶ For a more in depth review of the competition, refer Andrew Hutson’s article, “Square Peg in a Square Hole: Australia’s Parliament House” (2011)

(Refer diagrams 4.2-4.5), the partition physically representing the divisions in Australia's bicameral parliamentary system. In between the two houses, at the centre, is a ceremonial space, the 'Members Hall', cutting through the three levels. It is intended to function, on the members' level, as an informal meeting place for members of parliament as they cross from sector to sector. On the level above, the public wander around the perimeter overlooking the passage of their parliamentarians. Like the trafficable roof, it promotes the idea of 'the people' being able to overlook their governors at work. At the very centre of the hall is a pool made from a single piece of South Australian Black Imperial granite in which the flag is reflected through a glazed roof above.

In the front of the hill, facing towards the parliamentary triangle, lake and distant War Memorial, a forecourt plaza is carved out, paved with red gravel. It is furnished sparsely, with a low level fountain, a mosaic in granite sets designed by indigenous artist Michael Nelson Jagamara, and a white marble-clad portico, defining the public entry. On entering, under the 'great verandah', the public is presented with a richly, but reservedly, decorated entry foyer, populated by a forest of green stone-clad columns. It is at this close level that the extreme care taken with the surface detailing of the interiors is evident. Despite the building's enormous superstructure, there is an intimacy and craftsmanship in the overlay of timber, plaster, and stone veneers that humanises and brings a sense of constancy and comfort. Some seventy art and craft works were commissioned and built into the fabric of the building. Each piece was designed for a particular location. A key commission in the main foyer are twenty panels of timber marquetry depicting native flora from around Australia. The marquetry panels are intended to refer not only to the Australian landscape, but to the entwined histories of Aboriginal and European cultures. But, with the majority of the public spaces facing into primly designed courtyards, there is little connection back to the outside world from its interiors. It is not until the culmination of the public journey through the place, bypassing the secure third level, via elevator, to the top of the hill, standing under the flag, that there is a reunion with the powerful axes of the Canberra plan and topography.

- 1 Forecourt
- 2 Great Verandah
- 3 Foyer
- 4 Great Hall
- 5 Members' Hall
- 6 Senate Chamber & Offices
- 7 House of Representatives & Offices
- 8 Ministerial Wing

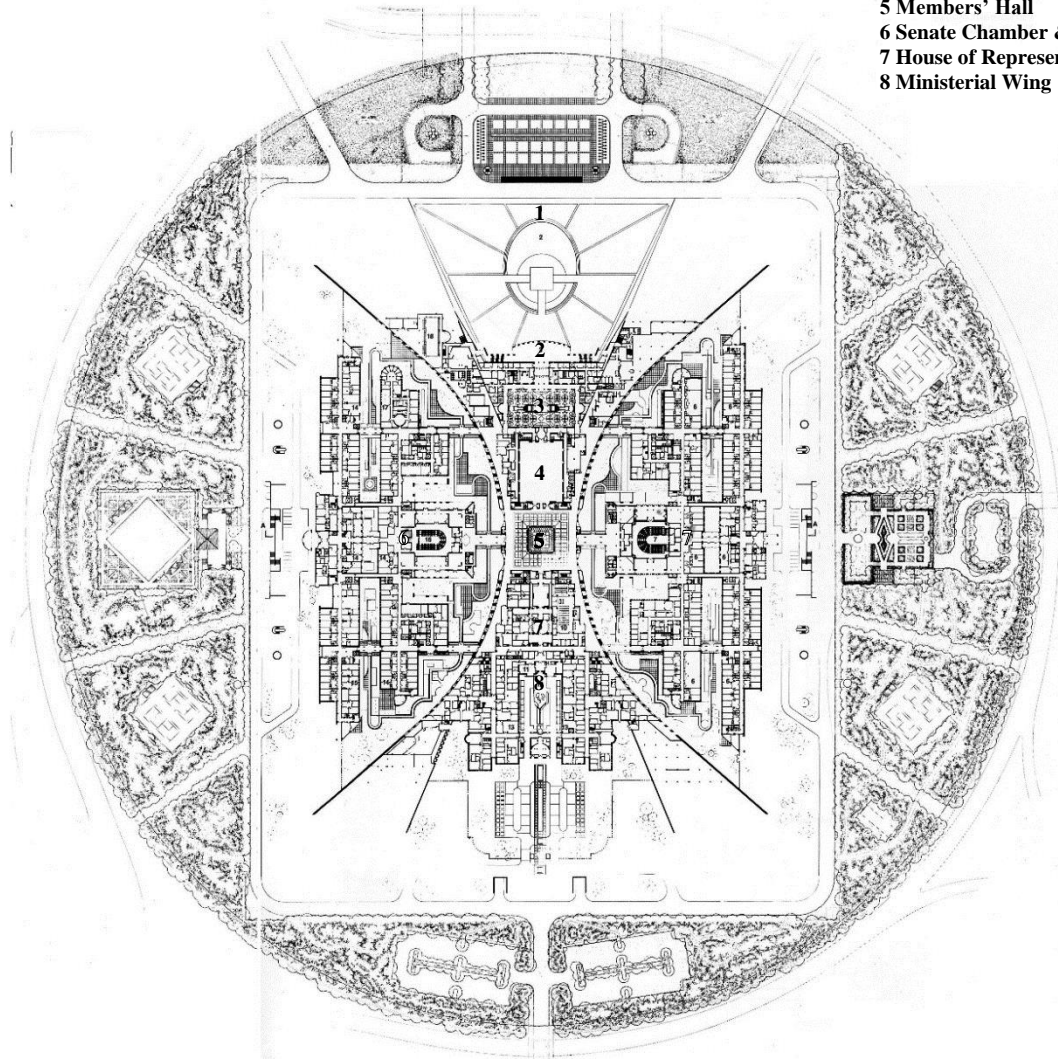

Figure 4.2 Parliament House, Canberra, Ground Floor Plan.

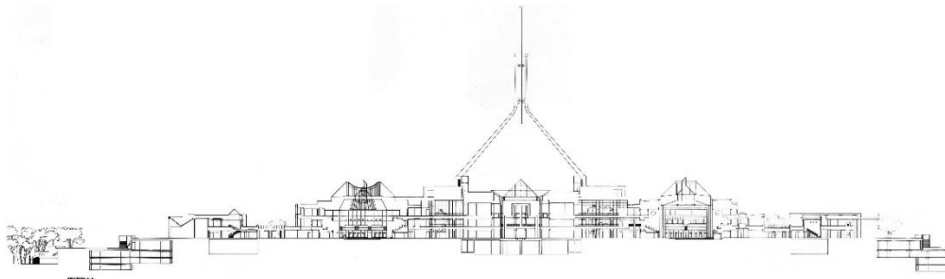

Figure 4.3: Parliament House, Canberra, East-West Section.

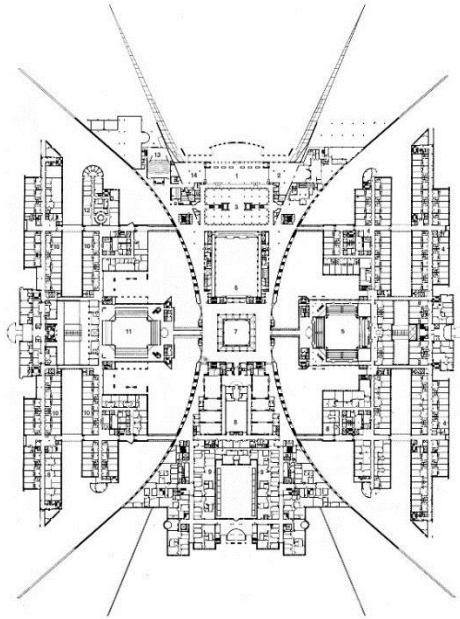

Figure 4.4: Parliament House, Canberra, Level 2 Plan

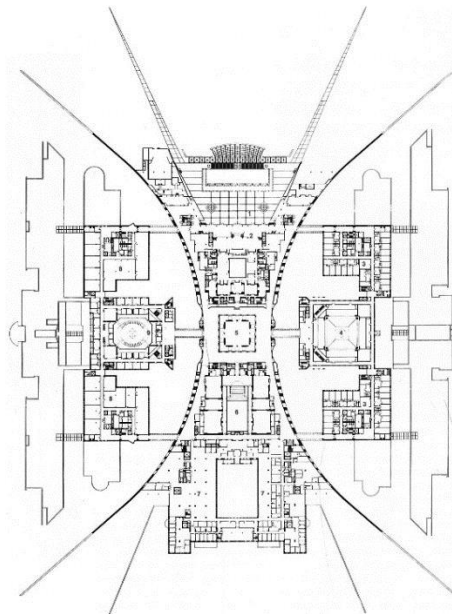

Figure 4.5: Parliament House, Canberra, Level 3 Plan

Before the results of the first stage of the competition were announced little was known in Australia about the winning New York-based architectural firm Mitchell/Giurgola and Thorp, led by Giurgola. Equally, having never visited the country prior to the competition, Giurgola knew little about Australia. To understand more about the transformation that took place in the 10 years from the announcement of the winning entry in 1980 until the opening of the New Parliament House, this

chapter will look at its background on both sides of the Pacific and the context of Giurgola's decision to remain in Australia.

Ultimately, Mitchell/Giurgola and Thorp's New Parliament House drew heavy criticism when the building was opened: neo-Classical lines, a Beaux Arts *parti*, and the building's occupation of Capital Hill were seen by many critics as neither relating to the Australian landscape and culture, nor, when compared to Jørn Utzon's Sydney Opera House, providing the daring architectural courage needed to inspire the nation. The critical issue for reviewers was the design's ambiguity; it was seen to be neither 'culturally challenging nor [sufficiently] site specific' (Tombesi, 2003). Detractors point to an overbearing design brief and the 'fast-track' procurement process as major influences in its failings. Giurgola's Swedish and Italian immersion at the end of the 1970s is not considered.

Now, 30 years on from the competition, this chapter looks at various facets of the project's history, design and making, including the contest of ideas in North America in the 1970s and early 1980s; the broader narrative of Giurgola's life surrounding the project (particularly the influence that resulted from his engagement with Sweden through the Volvo commissions); and, finally, some observations on the parliament building itself. I discuss the formal elements evident in Parliament House in relation to the latent patterns of Giurgola's earlier house designs. It is not intended to overstate the Swedish or Italian association rather, to highlight that Parliament House is the precursor to the later Australian buildings in which the other tradition of modernism flowers in his work.

Critical reception of the New Parliament House: An overview

*'yawn'*¹⁷

Debate on the chosen design of Australia's New Parliament House was sparked from the moment of the announcement of the winning entry by collaborating partners

¹⁷ Giurgola reported that a 'yawn' was the response of architectural critic Kenneth Frampton upon viewing the entrance hall to the Parliament House (personal communication).

Mitchell/Giurgola and Thorp. The design was promoted by its authors on two planks: the formal response to the position it occupied within the Marion Mahoney and Walter Burley Griffin design for Canberra; and its cultural dimension as essentially humanist, referring to an expression of democracy through a neutral, but poetic, anti-monument that looked to the land itself for inspiration and validation.

The winning design's formal response to the site and build-ability were qualities which the assessors of the competition recognised in reaching their unanimous decision, reporting that:

...the design we have ultimately chosen is an exciting and stimulating solution, which is functionally efficient, eminently buildable, extremely sympathetic to the site, and which exhibits, moreover, an outstanding empathy with Walter Burley Griffin's planning concept for the National Capitol... It derives a strong presence by merging built form with landform. The successful synthesis of these two essential elements has resulted in a design that is at once natural and monumental (Parliament House 1980).

The Sydney-based architectural historian and critic, Jennifer Taylor, announced it as the 'Post-modern Parliament' as did Norman Day (Day 1980), who stated that, 'The winning entry is a typical example of post-modern American design so it will always be a building of its time, a trend follower of the early 1980s'. Taylor focused on the cultural contribution of the design stating that with its 'balanced design, in part contained and controlled, and in part free and wilful' (J. Taylor & Buchanan, 1980) the building successfully translated the collective Australian aspirations for a new parliament. Further, she wrote in her report prepared for the Australia Council that the design is a 'proposition of an architecture containing both dignity and humanism'.

Once completed, the New Parliament House created a flurry of attention across local and international architectural media. Publications included two official monographs: *Australia's New Parliament House* produced by the Parliament House Construction Authority (1985) and *Parliament House Canberra: A Building for the Nation* edited by Haig Beck (Haig Beck & Mitchell / Giurgola & Thorp Architects, 1988); a special

issue of *Progressive Architecture* (Dixon, 1988; Murphy, 1988; J. Taylor, 1988); and articles in *Architecture Australia* (Giurgola, 1988; Turnbull, 1988) *Landscape Australia* (R. Johnson, 1988) and Deas 1988), *Landscape Architecture* (Johnson 1988), *Art and Architecture* (Jennifer Taylor, 1988), *Architectural Record* (Goad, 1988b), *Artcoast* (Goad, 1988a), *Architectural Review* (Corrigan, 1988; Cox, 1988; Indyk, 1988; Spence, 1988), and the *RIBA Journal* (Sharp, 1988).¹⁸

According to James Weirick in his detailed 1989 essay, *Don't you believe it: Critical Response to the New Parliament House*, the majority of these assessments, although largely complimentary, expressed, 'some very real doubts'. Mitchell/Giurgola and Thorp's parliament did not set out a clear ideological stance and glossed over real social and political history. In his detailed criticism Weirick was particularly barbed, stating that,

Instead, each citizen brings some awareness of history and social context to the building and this collides disturbingly with the apolitical emptiness of Giurgola's intentions....the only conclusion the individual can reach is that the building is not about democracy at all (Weirick 1989).

Instead, the dialogue around Mitchell/Giurgola and Thorp's description of their design philosophy positioned Parliament House in a safe 'Rousseauian' dimension, void of an attempt to capture the spirit of the time (Weirick 1989). Moreover, the design was automatic and never got beyond its diagrammatic stage. The plan neatly resolved the apex the Griffins' city plan with its outstretched arms pointing down its diagonals, but the 225,000 square metres of building complex did not translate to a cohesive experience on the ground. The internal spaces were derivative and the content of the building was reduced to layered surfaces.

¹⁸ See James Weirick's essay for a comprehensive review as well as a dissection of the political context surrounding the Parliament (Weirick 1989).

Other commentators noted that while being set into the hill allowed people to walk up and over Parliament House, thereby symbolically putting the people above their elected representatives, it implied something hidden. The segregation between public and member only areas has led some to question to what extent the building represents democratic ideals. Philip Drew (1994) compared Parliament House to Uluru which has become Australia's most identifiable natural symbol of its geographic centre, 'You could say that it is a kind of neat, lawn covered suburban version of Ayers Rock¹⁹...hence the New Parliament's natural dome suggests concealment and hidden power'. Cultural commentator Livio Dobrez (1999) surmised that:

New Parliament House, Canberra, an architectural complex entirely geared to the visitor, the spectator, hygienically sealing off the actual business of politics from its spectacle. This is because New Parliament House envisages politics in contemporary terms, as image-making, PR, in short, virtuality.

This 'sealing off' is not necessarily all of Mitchell/Giurgola and Thorp's making since the competition brief was specific about the separation of secure areas from the public areas and graduation of levels of security. Nevertheless their emphasis on the land form and the land axis in the Mahoney Griffin plan appeared to heighten the polemic surrounding the accessibility of members of government and statements of power related to land, landscape and nationalism.

The reasons later speculated for the perceived deficiencies were various. Firstly the competition was preceded by what many believed were sequential planning disappointments enacted contrary to the Mahoney and Griffin vision for Canberra, stretching back to the Griffins' own struggle to implement their design of the Federal Capital at the beginning of the century. Mahoney and Griffin's plan intended that the legislative assembly would be built on the lowlier Camp Hill, at a distance down from

¹⁹ A dual naming policy of Uluru/Ayers Rock was adopted in 1993 that recognises both the traditional Aboriginal name and the English name.

Capitol Hill for which the Griffins planned the city's crowning 'Capitol' building, a large ceremonial building for both official and popular events, more than for deliberation and counsel (Reid, 2002).

The decision in 1923 to build a temporary Parliament immediately in front of the Griffins' Camp Hill site, and in the absence of a patron or clear description for the institution that was intended to occupy the building intended to be the climax of the city, left Capitol Hill uncertain and a ready site for contest. In his dissection of the political context of the building of a new parliament house, Weirick went as far as to suggest that the Australian people probably got their just deserts for their apathy towards political institutions and, 'entrusting the shaping of their National Capital to a group of people with no interest in these things – technocrats and bureaucrats whose commitment to democracy had to be zero'. The criticism of Giurgola's parliament could well be a criticism of Canberra itself, a city detached from the centres of economic and cultural production of Sydney or Melbourne. The ambiguity for which Mitchell/Giurgola and Thorp's design was criticised had already built into the implementation of the Australian capital. Throughout Weirick's review, he portrays Griffin as hero and Giurgola as complicit in the undermining of a Canberra that might have been.

Secondly, an imperative described in the brief that the building be completed before the Bicentennial anniversary of British arrival in Australia in 1988 resulted in a competition in which entrants were asked to produce a design to symbolise Australian democracy and be delivered in a specified time frame. According to Weirick, the motivation for the selection of 1988 (rather than the bicentenary of Federation in 2001) was an instrument of the Malcolm Fraser led Liberal-Country party government to rejuvenate Canberra as the centre of power in the wake of the unusual occurrence in the dismissal of an Australian government in 1975. In Weirick's view Mitchell/Giurgola and Thorp's scheme neatly shoe-horned into a conservative view of governance in which the power elite are detached physically and symbolically from the populace.

Paolo Tombesi (2003) also argues that the project procurement and the controversy of the Sydney Opera House had a larger influence on the outcome than previously

credited. Tombesi reasons that the troubled gestation of the Sydney Opera House experienced thirty years earlier overshadowed preparations for Parliament House, and that at its heart the parliament competition favoured a utilitarian solution. The condensed program of procurement shortened the usual time between a conceptual competition – in which the architect had participated at a distance, geographically and culturally – and the development of the narrative of spaces they had touted in the initial design report.

Mitchell/Giurgola in the 1970s: Italian and Swedish connexions

Mitchell/Giurgola first became aware of Parliament House competition when in 1979 Sir John Overall, a member of the newly formed Parliament House Construction Authority (PHCA), telephoned the Mitchell/Giurgola office in New York to make an appointment with Giurgola. Sir Overall informed Ann Olavson (Giurgola's secretary) that he had come to the United States hunting for two competition jurors (H. Guida, 2007). Later on, prior to gaining the opportunity to meet Giurgola, Overall selected the Chinese American architect Ieoh Ming Pei; Giurgola's contemporary, and the Australian architect, John Andrews. Both were known to Giurgola through their contact in East Coast architectural circles. Giurgola had advised on the Port of Miami Passenger Terminal, a commission won by John Andrews. Having already filled the jury positions for the Parliament House competition, Overall visited Giurgola and invited him to participate in the competition.²⁰

In 1979 Mitchell/Giurgola consisted of two offices: Philadelphia and New York. Phase 1 of the parliament competition entry was undertaken in Philadelphia(1979) but by phase 2 the work moved closer to Giurgola in New York. Giurgola's participation in the design was fragmented between the two offices; and his commitments to Yale meant that his time on each design was limited to participation at design meetings, sketches and notes that he often prepared en-route to the next meeting (H. Guida, 2007).

²⁰ Giurgola's much publicised claim is that he refused the juror invitation in favour of competing.

Around the time of the design of the Parliament House competition, Giurgola explained his way of working,

I like to work with other people very much. I make a point of working in a group, and I really believe you can obtain much better results by working in a group. I always do sketches and drawings in the office. We always sit around the table and if I have any ideas I will put the ideas in front of everybody...I say that is what I have been thinking and I make a sketch. Everybody starts to think about it... then we try to see that the work is...successful; instead of putting five people on a thing we put two and we try to make it in time (Chang & Architects, 1977).

Mitchell/Giurgola projects of note in the 1977-79 period include the Life Sciences Building, New York (1977), Lukens Steel Company Administration Resources Center, Pennsylvania (1978), The American College Graduate Studies Centre, Pennsylvania (1978) and Giurgola's design consultation for the preparation of a Master Plan for the United States Capitol and the Capitol Grounds – this likely caught the attention of John Overall when looking for competition jurors. With the exception of the Lukens Steel building, the tenor of the commissions was major public buildings. Mitchell/Giurgola received critical praise for their architecture of this period in the United States. Frampton, for instance, commented that the Graduate Centre is one of Mitchell/Giurgola's finest buildings to date (Frampton, 1983). Similarly he states that the Luken's complex is, '...one of the most elegant and efficiently planned administration buildings erected in recent years...', attributing the building's composition *parti* to Alvar Aalto and to Asplund for the deployment of a series of free-standing orthogonal pavilions, running in front of a suppressed mass.

In conversation with Giurgola, he recalls his earlier tribute to Aalto of 1976 and stresses the importance of his first knowledge of the Finnish master during a visit by Aalto to Italy:

It was soon after the war and everyone in Italy was talking about how we should start re-building the cities. The old cities were built on the hills while the railways and industry where in the valleys, so

it made sense to leave the old towns and start afresh next to the means of transport and place of work. Aalto was there in Italy at this time and he said, 'if there is only one chimney left standing in the old town, this is where you should build' I was very impressed by that (Giurgola, 2002c).²¹

As the office tackled the second stage of the competition, Giurgola tried to understand more about Australia through its literature and the Australian architect Ric Thorp who had joined his office. Giurgola explains:

Australia fascinated me. I only read Patrick White, Voss, and the Manning Clark Short History of Australia. That was my knowledge of Australia. It fascinated me this notion of moving west because there was this little place of Western culture still alive, surrounded by this great continent of Asia and the Pacific Ocean so it really was another world. The history was interesting because it was a basic survival history, in every sense of the word, and yet with this democratic sense of leaning together in a certain way. Then the room, the kind of great room that there was. I was very conscious of all that when I started the competition... The only connection that we really had to Australia was Ric Thorp. And he was really a pain in the neck because everyone was complaining because he was talking so loud and he was talking with this Australian accent. He

²¹ It is not clear if Aalto was present in Italy in the late 1940s as Giurgola suggests. From 1946 to 1948 Aalto was a teacher at the Massachusetts Institute of Technology and was in the process of completing the Baker House Dormitory commission (1947-1948), returning permanently to Finland in 1948. Although an article does not appear to have been published in *Casabella* as suggested by Giurgola, Aalto's "Architettura e arte concreta" was published in the Italian journal *Domus* in 1947. This article may well have been Giurgola's first exposures to Aalto and Aalto's part in the theoretical debate on the problems of rationalism in architecture. The oft-quoted paper was later published as "Taimen ja tunturipuro (The Trout and the Stream)" in the Finnish journal *Arkkitehti* in 1948.

was working hard too but he tended to take it easy and I liked that idea. So we asked him to be part of the team (Giurgola, 2002e).

Looking back on the eventual move to Australia, Giurgola saw the country as a fresh start. He states, ‘...I had this rather successful career in the States but I was feeling that I was repeating myself. Even though I loved America — I made my career there — I got a little bit tired of that kind of taking things in the surface of things’ (Giurgola, 2007b).

Alongside the upcoming competition entry for Parliament House and commissions in the United States, Giurgola was involved in the US Agency for International Development’s work in the Friuli area of north-eastern Italy. The Friuli area had been devastated by the earthquakes of 1976. Giurgola designed an elementary school in the town of Aviano (1981), a Technical High School in Maniago (1981), and Student Housing in San Pietro al Natisone (1981) that all feature characteristics of vernacular northern Italian buildings: rendered wall surfaces and terracotta pitched roofs. The Friuli designs also show experimentation with marble facades, terracotta roofs and fenestration, some of which display a degree of peculiarity in the out of step rhythms of window placement as in Asplund’s Snellman House (1918) (See Figure 4.10).

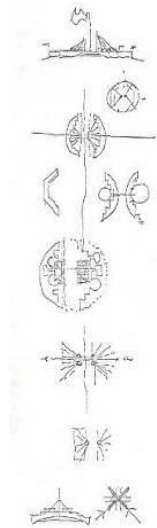

Figure 4.6: Giurgola's exploratory sketch diagrams of the Australian parliament. Mitchell/Giurgola (1983)

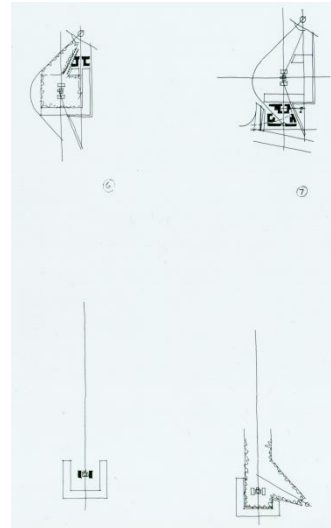

Figure 4.7: Diagrams the US Capitol Master Plan, 1977-1981. Courtesy of The Architectural Archives, University of Pennsylvania. Ref: 267.II.A.132



Figure 4.8: Elementary School, Aviano, Italy, 1981. Courtesy of The Architectural Archives, University of Pennsylvania. Ref: 015.V.103

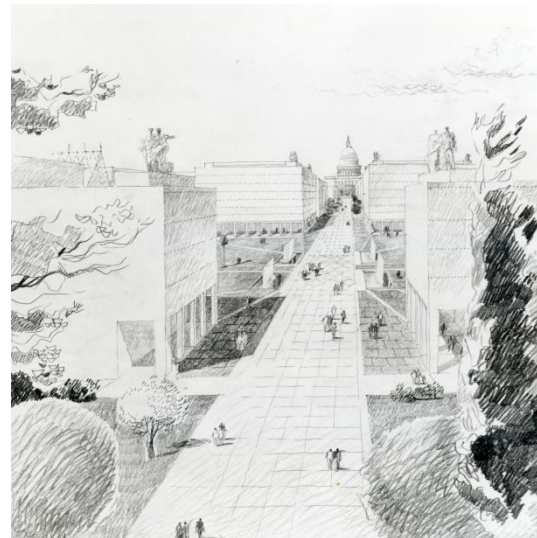

Figure 4.9: Sketch from the US Capitol Master Plan, 1977-1981. Courtesy of The Architectural Archives, University of Pennsylvania. 015.V.106

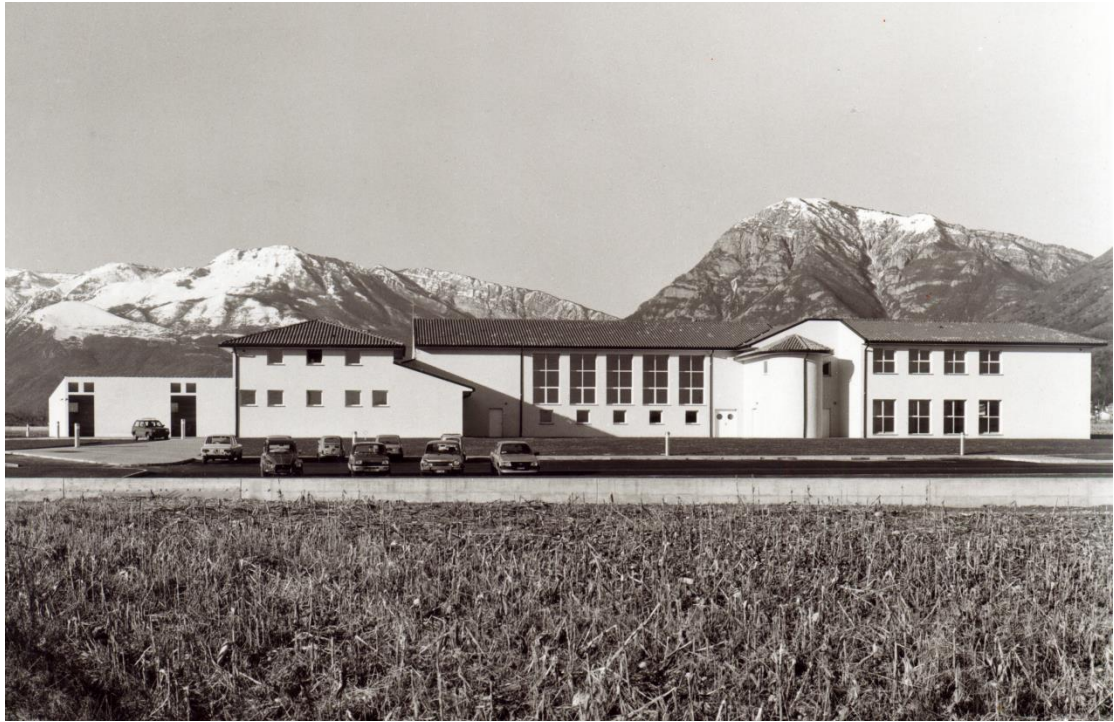

Figure 4.10: Technical High School, Maniago, Italy, 1981. Courtesy of The Architectural Archives, University of Pennsylvania. Ref: aaup.015.V.105.4



Figure 4.11: Student Housing, San Pietro al Natisone, Italy, 1981. Courtesy of The Architectural Archives, University of Pennsylvania. Ref: 015.IV.051b

It was also around the mid-1970s that Mitchell/Giurgola's association with Volvo began when the Swedish car maker expanded into the United States. Pehr G Gyllenhammar, an avowed social liberal²², was managing director of AB Volvo from 1971 to 1990. On a visit to the United States, Gyllenhammar (2011) was impressed with the work of Mitchell/Giurgola and appointed Giurgola as architectural advisor to Volvo and commissioned the firm for an extension to the Volvo factory in Chesapeake in Virginia.

Giurgola's discussion and friendship with Gyllenhammar had a significant influence on Giurgola's thinking, especially regarding the environmental conditions of workers and the inclusive, team-based work methods that Gyllenhammar promoted (Berg, 2007). In conversation with Stephen Frith in 2000, Giurgola reflects on his relationship with Gyllenhammar and Volvo:

There was a certain empathy between us, as there is with some artists when you meet them. We were really engaged in time and in the work. Several members of the office went to Sweden to study Volvo manufacture. We started to make sketches for the new plan in Virginia. We started to know people there...it was an attractive experience. We designed the factory, and did one module of a larger project before the economy changed, and the rest wasn't built (Giurgola 2000, quoted in(Frith, 2010)).

Giurgola advised Volvo on several expansion projects, although not always in the role of the lead architect. Gyllenhammar explains that Giurgola was happy for local architects to have the major role and this was the agreement for the factory in Torslanda where a Swedish architect²³ was the lead designer (Giurgola 2002). At

²² Gyllenhammar's was a member of the Liberal Party's board and is said to have been a candidate for party leader. He also wrote two books on the nationalist/socialist theme, *Jag tror på Sverige (I believe in Sweden)* Askild & Kärnekull, 1973 & *People at work* Addison-Wesley, 1977.

²³ It is assumed that this was Swedish architect Owe Svard who was also the local architect for the Volvo headquarters building.

times Giurgola's office did not find support for their work in Sweden, a country with strong socialist beliefs. In conversation with Stephen Frith, Giurgola explains that a Swedish newspaper published an article criticizing the firm for their patronage by capitalists with the same title as Giurgola had used in answer to the New York Five discussed earlier, 'The Discrete Charm of the Bourgeoisie'.

Giurgola became more closely involved with the design of the Volvo headquarters building in Gothenburg, designed in association with Ove V. Svard. The building received the 1985 National Honour Award from the American Institute of Architects. Gyllenhammar argued that the architects should make the headquarters like a villa, not like an office building (Giurgola 2000, cited in Frith 2011). According to Gyllenhammar (2011), prior to, and during the commission, Giurgola travelled extensively through Sweden, sketching the landscape and villages, with a particular interest in church buildings. When Gyllenhammar questioned him on the sketches, Giurgola replied that churches represented the aspirations of people because in the past they did not have any other place or institution of social gathering.

It was on these journeys that Giurgola observed the qualities of natural light in Sweden, noting that it had a more diffuse quality when compared to the harsher shadows created by the Australian or Roman sun. It is something he noted that the Nordic architects made good use of in their buildings. Of the Volvo headquarters he says:

That is why the Scandinavians like the window near the edge of the wall, not in the centre...I did this building with that in mind. In Scandinavia it is as if the building is painted into the atmosphere... (Giurgola, quoted in Frith 2010)

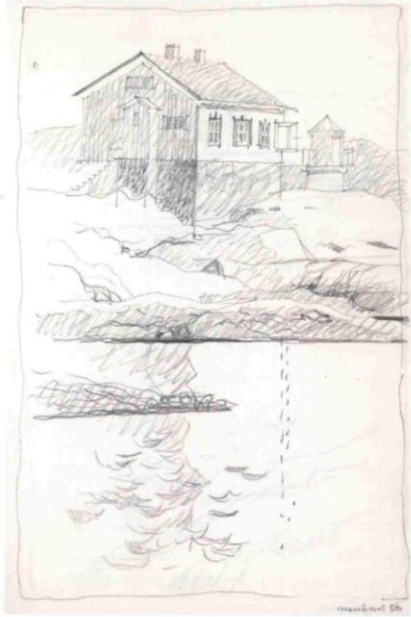

Figure 4.12: Romaldo Giurgola, *Holiday house of Pehr Gyllenhammar, Island of Marstrand, Sweden.* Sketchbook A7 1980/81



Figure 4.13: Romaldo Giurgola, *Göteborg, Sweden, 14/12/86, Sketchbook A5 1986*

Through the Volvo commissions Giurgola also became involved with local artists and craftspeople which were part of the company's social program. This deepened the cultural exchange between the staff in Giurgola's office and Sweden. The initiative for artists to contribute to the interiors of the Volvo headquarters was developed

between Giurgola, Gyllenhammar and Pam Berg. There is also mention of his time at the American Academy of Rome where he met Pam Berg. He explains:

I was coming back from the American Academy of Rome. After I had that heart attack I had some rest over there. I met Pam there and we had a good exchange of ideas, about the function of art into our environment. For instance she was very much looking at the changing perception in art: not the masterpiece of the Renaissance, glorifying one idea of a person, but the distribution into society and the formal expression that is generated by that very wide topic. Strangely enough when I came here I found that. There were not great artists around, or one that was celebrated, but there were a lot of people doing this thing: the bottle, or the tapestry, no-one that was really celebrated as a genius like in the States. You can open a show and become a genius immediately but then they deflate you. It was very interesting this interaction with Pam. Then she came to work in the office - mostly she was working in Philadelphia but we did the project of Volvo together. There we tried to apply to a great extent this notion of the participation of art into the architecture. Not as an after-fact, or as a postage stamp on the wall, nor even an image of something in order to fill the space, but as belonging to the process of making the space. She made a programme where we hired the artists at the beginning of the work. We found the president there, Pehr Gyllenhammar, a really enlightened person. He supported us very much and instituted a board for art and architecture....we came up with an art programme which Pam formulated. They had a lot of craft schools in Sweden that were closing because they didn't have enough students. Volvo started to give grants to the school so Pam developed a programme from which the company was producing money and we started to repopulate the schools (Giurgola 2002).

Lin Utzon, daughter of the Sydney Opera House architect, Jørn Utzon, was one such artist that Giurgola met through a common friend following her return from Australia. The 34-year-old Utzon was an unemployed artist recently returned to Denmark following her divorce from Australian architect Alex Popov. It was also reported that Giurgola came to know Jørn Utzon and visited him on several occasions during the parliament years (H. Guida, 2014). This must have given him an entirely different perspective of Australia:

...he is a wonderful guy but he is not too well now. These Nordic people they have this mind that all of a sudden explodes. They become very sarcastic and laugh all of the time. You wonder what is going on. He is a very generous guy. In a way he was a very unhappy. He was a great artist and he didn't do practically anything else other than the Opera House; the Parliament in Kuwait. And both of them, one was bombed and never finished and reconstructed in a makeshift way. You can count on your fingers what he did. He has this sort of mix of a generous attitude to life and at the same time the cruelty of all that. Like Ibsen perhaps (Giurgola, 2007b).

Amongst the works that Giurgola had seen of Lin Utzon's art work was her textiles in the Bagsværd Church from 1976, developed in collaboration with her father, and brother, Jan Utzon. In consultation with Giurgola and Berg, she designed and implemented a 36 meter long mural in porcelain tiles for the Volvo Headquarters, designed the director's table and several tapestries hung in public areas of the building.

Giurgola explains the relationship:

One of the artists was Lin Utzon and she started immediately: before we even started the design. I already had this notion of this big wall that she did. She worked in many parts of the building. She was working with Royal Copenhagen and doing cups and things like that. I saw one of those cups and it came to my mind to have her do a very big commission. And that is how her life changed too

in terms of doing things because since then she did a lot of work for us. She did the work for us in San Francisco for the garden that we did there, and San Jose for the convention centre. In Texas for the IBM we also had some of her work. In fact just the other day I received her book. She lives in Majorca now. This is the cup that I have over there (Giurgola 2002).

Stephen Frith's conclusion is that the cultural exchange between Mitchell/Giurgola and Volvo assisted the design of Parliament House, particularly the villa-inspired scale of the Volvo Headquarters building. And yet, Giurgola was focused in the initial phases on the relationship with the Canberra plan, memories of Italy and his personal journey,

... the site was a circle and so I started to occupy it like a citadel there. I had the images of those town in Italy, where you have a sense of a wall and things appear on top, where you have a hint of what is going on inside without knowing precisely...[it] wasn't the right concept in terms of a new place ... the tremendous exhilaration I'd always had of a virgin country or a new place ... So I thought that that constrictive plan is an echo of old cities that wasn't right, so I reversed this wall ... and the wall became open to all the outside...(Giurgola, 1989)

Similarly, Hal Guida (2007) remembers the early stages of the Parliament House competition entry as it was being developed in the Philadelphia office:

We had been investigating a scheme of two wings of buildings facing each other that incorporated the massive thing: these walls with all their functional things and it was a circle in a circle and Aldo always resisted that kind of concentric planning although his planning is very geometric very, very often; concentric planning is almost dead ended. He recognised that as Classicist. There was this scheme and it was concentric but it had its own freedom. Fundamentally - it was a wonderful thing - Aldo took the pieces and switched them. Everything fell into place from there: the

*engagement with the city; the marking of the axis; the cross axis;
the tensions of the two walls coming close to each other to make the
centre of the hill; and so forth.*

Thus, the first stage design fell into place by a serendipitous moment that brought the elements of the building into synchronization with the Mahoney and Griffin geometry and Canberra topography. The simple, yet decisive move set in train the development of the design away from a palazzo around a cortile to the outstretching arcs that distinguished the Mitchell/Giurgola entry from other similar Kahnian inspired *partis* present in the competition entries²⁴.

However, one outcome of the encounter with Volvo and Sweden was the considerable budget that was set aside for an art program to be managed by Pam Berg. Giurgola employed local artists and artisans in Australia for Parliament House hoping to recreate the ‘practical art’ achieved by the Utzon family in the Bagsværd Church and by Lin Utzon at the Volvo Headquarters.

²⁴ See Hutson, A (2011) for an analysis of the range of competition entries for the Parliament House competition.

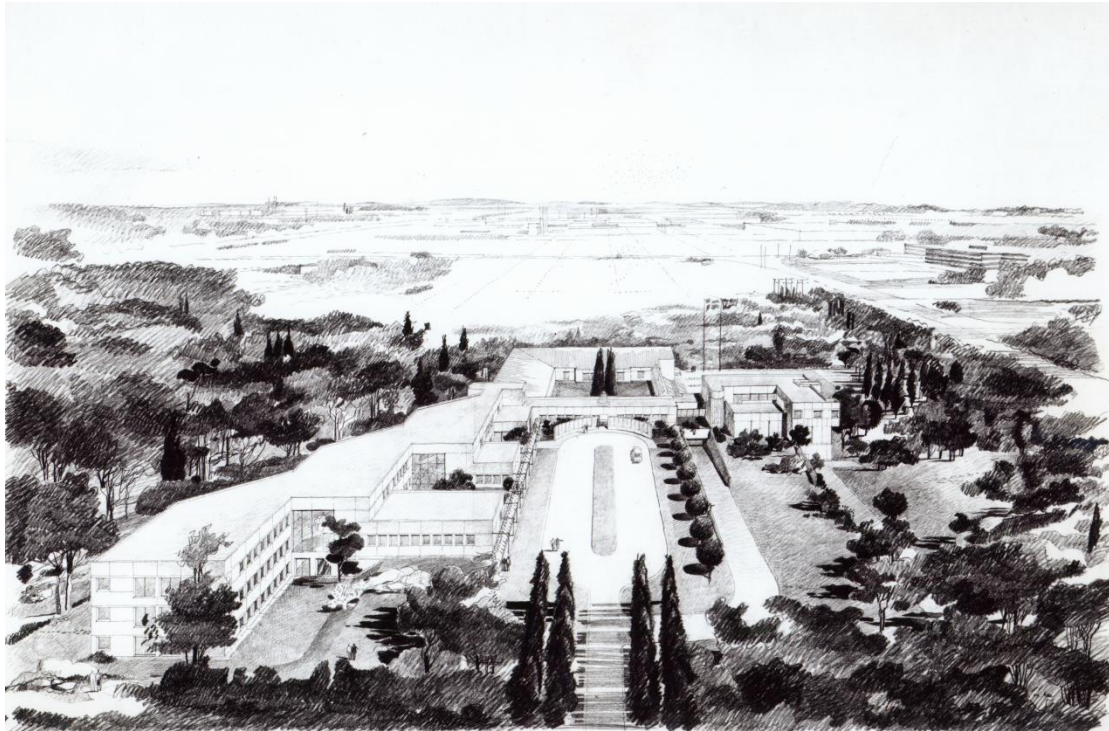

Figure 4.14 Volvo Headquarters, Torslanda 1984. Courtesy of The Architectural Archives, University of Pennsylvania. Ref: 267.II.A.151

The 1980s American Scene

At 62 years of age, Giurgola was at the height of his power and influence in the United States. To capture the moment, the monograph mentioned earlier was published in 1983 looking back at 25 years of Mitchell/Giurgola. Contemporaneously, in November 1982, the iconic debate occurred between Peter Eisenman and Christopher Alexander at Harvard University, setting the scene for American architectural culture of the 1980s. On the East Coast, Peter Eisenman was one the major protagonists in the emerging Deconstructivist program. Meanwhile on the West Coast, the Austrian-English émigré Christopher Alexander, proposed that the built environment be generated by collective intuition, normative ‘patterns’ of production, and organic aggregation. The debate offers the opportunity to position Giurgola in the architectural milieu on the East Coast of the United States at the beginning of the 1980s.

After a string of attachments to different intellectual social theories, Eisenman was drawn to the post-modern theory of deconstruction through his collaborations with the

French post-structuralist thinker Jacques Derrida. He argued that the role of architecture in society is to question the structure of itself, to create disharmony in the composition of architectural elements. Through this, people will be prompted to question accepted norms and positively contribute to the development of human society. If disharmony and anxiety is not present in people's lives then they may be lulled into 'thinking everything is all right, Jack, which it isn't' (1982). The role of art or architecture, as Eisenman saw it, was to remind people that everything wasn't all right. It is clear that Eisenman celebrated the role of the individual artist to bring about change.

On the other front, Christopher Alexander reacted against Brutalist modernism and what he saw as an alienation of the self from the collective underlying Modernism and the steady embrace of a scientific world. Opposition to this type of disconnected 'unfeeling' architecture saw his rise to prominence through *The Oregon Experiment* (1975) at The University of Oregon, the test bed for his better known *Pattern Language* (1977) in which Alexander proposed to build according to an established set of patterns that followed a 'natural order', an order existing in all things. For instance, his famous claim that roofs were pitched for very good reasons. The disruption of what he saw as the natural order occurred with the slavish acceptance of scientific method, stating that, 'Up until about 1600, most of the world views that existed in different cultures did see man and the universe as more or less intertwined and inseparable...we have been trained to play a trick on ourselves for the last 300 years in order to discover certain things' (Eisenman & Alexander, 1982).

While the Eisenman and Alexander propositions are ostensibly poles apart, they are somewhat akin in that they both pursued abstract concepts. Alexander's proposition appears to be the less cohesive of the two as is evident in Alexander's ambivalence when it comes to justifying his patterns. This vagueness is most clearly expressed in the notion of a 'quality without a name' which is at the heart of his theoretical treatise. He claims:

There is a central quality which is the root criterion of life and spirit in a man, a town, a building, or a wilderness. This quality is objective and precise, but it cannot be named (Alexander, 1979).

Considered individually however, Alexander's patterns, often respond only to a select subset of contexts ignoring inconvenient ones from broader political and social realities. It has been argued that Alexander's work runs directly contrary to many aspects of the capitalist, consumerist and individualistic societies in which we live (Dovey, 1990). By contrast, the cohesive strength of Eisenman's proposition for designed dislocation was found to be compelling and received much wider popular support.

Giurgola did not engage directly with this contest but nonetheless his 1983 reflection, entitled 'Constants' published in the monograph, mentioned above, appears more aligned to Alexander than Eisenman. Like Alexander, Giurgola expresses empathy with the phenomenological experience of architecture. In fact, Giurgola states his outright opposition to Eisenman's proposal, writing that he is dedicated to 'the resolution of the inherent contradictions in life and the balancing of opposite forces rather than the mere restatement of them.' Thus Giurgola believes that architecture should be thought about in terms of its contribution to human experience. He states that the affirmation of these experiences contributes to 'people's aspiration for a better life' and it is the role of the architect to reinforce good behaviours. With respect to the past, again agreeing with Alexander, Giurgola sees the architectural art as a continuum – not all past architectures should be tossed out. He makes specific reference to ancient Greek architecture being able to find the right balance between 'our forms and the forms of nature'.

And yet, this is where Giurgola differs from Alexander. Instead of trying to provide a universal answer to how we should build, Giurgola acknowledges that the world at the beginning of the 1980s is a much more complex place than could be fully understood. Giurgola states that 'we [architects] must become more sensitive to individual human issues while at the same time working with unaccustomed dimensions'. When Giurgola talks about constants he does not express a belief that there exists a universal order of all things and all architectural production should be seen through this universal vision. Instead he states that an 'all-encompassing total view' is 'something to which to aspire to rather than as something from which to begin'. His constants, he states are 'infinitely variable and malleable, being constant only in their existence as

eternal elements related to concerns in human life'. Giurgola's humble declaration describes a continuous concern about getting the right things done for a specific situation rather than the rationalisation of abstract theories, echoing the malleable model of modernism posited by St John Wilson. Despite having known St John Wilson, it is not an influence that Giurgola himself acknowledges.

By the mid-1980s Alexander's 'New Paradigm' was marginalised, as professional opinion steadily embraced Eisenman's ideas. A number of reasons have been put forward as to why this occurred. They include accusations that the sensation and spectacle generated by Deconstructivist architecture was more easily marketed; that it was a good fit with a late-industrial society, 'seeking ever more thrilling forms'; and that a good portion of Alexander's pattern language required the unpalatable erosion of capitalism (Steil, Hanson, Mehaffy, & Salingaros, 2004). The majority position championed by Eisenman was thus the backdrop of Giurgola's exit from the United States. It is coloured by a shift from the rationality of modernism and to the sensory and intellectual aspects of post-modernism culminating in the Philip Johnson and Mark Wigley's 'Deconstructivist Architecture' exhibition at the Museum of Modern Art of 1988, a canvas on which Giurgola's Parliament House was be received internationally and judged out-of-step.

Australian anticipation

Meanwhile in Australia, the fledgling RMIT journal 'Transition' in 1979 led off its second edition with a description of the 'Sydney School' followed by the publication of criticism of an exhibition by 'Four Melbourne Architects' presumably designed to draw a distinction between the architecture of the two centres of cultural production, Sydney and Melbourne. The third article in the journal described '9 Designs from Melbourne: Parliament House Competition'. Although the legitimacy of a Sydney School has since been questioned (Fung, 1985), the commentaries set the scene in Australia as the Parliament House competition opened.

The Sydney article's author Jennifer Taylor describes a group of architects based in and around Sydney pursuing a regional modernism that rationally responded to the physical and temporal context as well as the 'casual informality of many an

Australian lifestyle' (Jennifer Taylor, 1979). Architecture in which, 'Cobwebs, untidy piles of books, scattered tapes and records, and unmade beds seem quite at home'. For Taylor architects like Ken Woolley, Michael Dysart, Philip Cox, John Andrews, and Glenn Murcutt were accomplished practitioners of the style. Meanwhile Melbourne Architects Peter Crone, Maggie Edmond & Peter Corrigan, Greg Burgess and Norman Day exhibited their 'cultural inscriptions' (Peake, Drew, & Anderson, 1979) in which they describe the rediscovery of visual codes over function. Commentators at the time pointed to the re-focus away from European concepts to those derived from the United States. The influence of Christopher Alexander's patterns is evident in the work of Greg Burgess, and Peter Corrigan and Maggie Edmond's work is noted for its association with Robert Venturi, Corrigan's teacher at Yale University.

The '9 Designs from Melbourne' that followed described their schemes without exception through the lens of symbolism, exploring the translation of the meaning of a Parliament in post-colonial Australia into architectural form. Verandas, diagrammatic representations of the Federation, elements of the Australian landscape, and a 'Geometry of Disorder' were a few of the images around which central ideas in the schemes were conveyed. The Melbourne quarter thus anticipated that a new parliament building would be full of symbolism and reference to Australian mythology.

At the same time, Nordic architecture became a more popular reference in Australian architecture. Aalto, particularly, became a more prominent figure in the teaching and discourse of Australian architecture through the 1960s and 1970s, with more students and architects becoming aware of his work and visiting Aalto's buildings in Finland and elsewhere²⁵.

Other Possible Parliaments

Eisenman's deconstructivist proposition was perhaps formulated too late to have much influence on the Australian Parliament competition. Neither did a 'Christopher

²⁵ For a fuller discussion on the influence of Alvar Aalto in Australia, see (Radford & Schrapel, 2014)

Alexander's proposal appear.²⁶ Alexander's cosmology did not consider the concept of a national capital and his patterns did not include buildings of the nature or scale of Parliament House (Alexander et al., 1977)²⁷. A number of other contemporaneous themes of the late 1970s period were also not well represented (Hutson, 2011). They included the influence of the hi-tech created by Renzo Piano and Richard Rogers' Centre Pompidou, published in journals at the time. The parallel influences of Archigram and the Metabolists were found in a significant number of schemes but did not feature in the assessor's short list.

In the Brutalist vein, Colin Madigan's entry to the Parliament House competition further asserted his vision of Canberra. The project was one of a number of entries that challenged the symmetry of Griffin's parliamentary triangle. Consistent with the modernist deference to site legacies, Madigan instead drew on geometries unrelated to the site (Hutson, 2011). His competition winning scheme for the National Gallery and the later High Court, completed in 1982, had already clearly articulated a modernist 'form follows function' philosophy, particularly evident in the importance given to an expression of the lift shafts in the composition of the High Court, the most prominent of the two buildings in the Canberra landscape. Yet, its brutal concrete materials, multi-faceted asymmetrical shape and stepped outline give the appearance of a ruin eroded from a previous occupation of the site, or occupation built as a landform.

Mitchell/Giurgola's Condon Hall, built to house the School of Law at the University of Washington, Seattle, appeared to be along similar Brutalist lines. Completed in 1975, the building's circulation is accentuated by vertical expression of the elevator shaft, and in the horizontal, stretched masses hanging from each side of a central passage. Its elongated form and screens are the antecedent for the later university

²⁶ Eisenman's entry and Bernard Tshumi's influential winning design for the 1982/3 Parc de la Villette competition was widely published but post-dated the Parliament competition.

²⁷ Alexander instead concluded that the 'natural limit' for satisfactory human-human relationships was somewhere in the region between 2 to 10 million people, subdivided into communities of around 7000. Beyond that size governments disregarded local needs and repressed local culture.

campus buildings in Australia. Constructed from *insitu* poured concrete, finished raw, it has many of the hallmarks of the Brutalist style of architecture, the concrete tower received many architectural awards, including a Citation of Excellence from the American Institute of Architects (AIA), Philadelphia Chapter, 1976, and the Distinguished Building Award, Pennsylvania Society of Architects, 1977. Little scholarly interpretation was given in architectural criticism at the time of its completion (-, 1977) but later on it attracted criticism that was typical for Brutalist architecture. Upon the proposal to build a new law school 20 years after its completion, *The Seattle Times* reported that the UW Hall was, ‘...an ugly, badly designed, 20-year-old structure. With its narrow halls, windowless classrooms and sparse public spaces, the exposed concrete building is only slightly more appealing than the county jail’ (King, 1996).

And yet, there are elements like the thin, projecting pre-cast concrete sunscreens that do not easily fit the model. They have an exaggerated fineness against the backdrop of the bulkiness of the main blocks, giving them a light, screen-like appearance that has a closer relationship to the finely tailored concrete facades of Luigi Moretti’s 1950 Casa ‘Il Girasole’, and are a precursor to the themes Giurgola developed in his St Patrick’s Cathedral that will be discussed in chapter 6. There is also the interiors of the building that bear resemblance to Aalto’s Mt Angel Monastery Library in Oregon completed 5 years earlier. Clear articulation of structure, level changes, and the use of slatted timber are shared features of the two buildings. Guida, principal designer for the UW Hall, recalls a trip he took with Rollin La France (the building’s project architect) to see Aalto’s library in 1971 when the building was near the completion of documentation. Guida noted the distinction Aalto drew between finishes and materials of the library proper (detailed in timber and bronze) and the back-of-house spaces that were detailed economically and durably, ‘A good lesson – we used a somewhat similar approach to the use of materials in Parliament House’ (H. Guida, 2014).

Aalto’s libraries also had influence on other Mitchell/Giurgola buildings. An initial scheme for the William Jeanes Memorial Library (See Figure 4.20) has Aalto’s fan shaped reading room –albeit pulled into a more geometric layout of semi-circles and

diagonals; and the Tredyffrin Public Library that inverts the semi-circular plan and echoes Aalto's concern with internal landscapes.



Figure 4.15: Condon Hall, School of Law, University of Washington Seattle, 1973-5. Courtesy of The Architectural Archives, University of Pennsylvania. Ref: 342.II.37



Figure 4.16: Luigi Moretti's 'Il Girasole' (1947-50). CC BY-SA 3.0



Figure 4.17: Condon Hall reading room interior. Photograph by Harold Guida. Used by permission.



Figure 4.18: Mt Angel Monastery Library. Photograph by Omar Hason. CC BY-SA 3.0



Figure 4.19: Architects at work circa 1977:
Unknown (far left), Rollin La France (left),
Giurgola (centre) and Harold Guida (right)

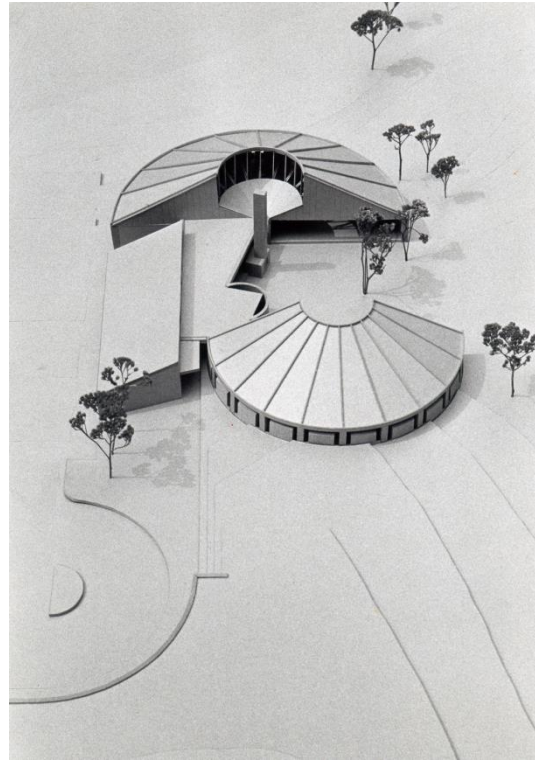

Figure 4.20: William Jeanes Memorial Library,
1967 –unbuilt. Photograph by Rollin La France.
Courtesy of The Architectural Archives,
University of Pennsylvania. Ref: aaup 267.II.A.160

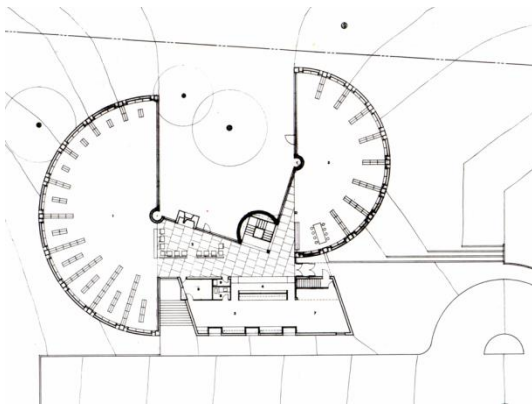

Figure 4.21: William Jeanes Memorial Library,
1967– unbuilt. Courtesy of The Architectural
Archives, University of Pennsylvania. Ref: aaup
342.II.42

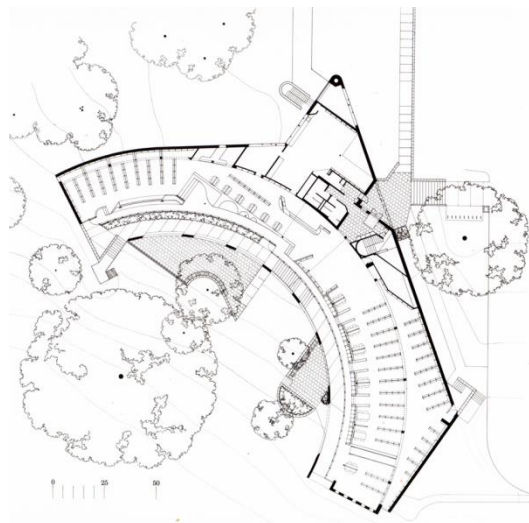

Figure 4.22: Tredyffrin Public Library, 1976.
Courtesy of The Architectural Archives,
University of Pennsylvania. Ref: aaup.015.V.092.2

‘Fitting in’: Some observations on Parliament House from a distance



Figure 4.23: View of Parliament House from War Memorial Drive. Photograph by Max Jefferies.

Almost 30 years on from the completion of the New Parliament, about halfway down the Australian War Memorial, looking down the ceremonial axis of Canberra, the central aspects of the design are laid out below. From this posture, its strongest design features are manifest: a symmetrical disposition about the Griffin’s land axis, two arc shaped flanking walls, and a towering flagpole structure. It is an image that Australians have generally become familiar with and it was its simplicity at a macro scale that set it apart from competitors, according to competition jurors²⁸. It sits at ease within the latent Griffins’ geometric overlay on the natural topography of the Molonglo valley. It ‘fits in’. The outstretching arms of the arced walls and centrally located flagpole re-affirm the two flanking diagonals of the Griffin’s Parliamentary Triangle and the symbolic centre of the Griffins’ plan. Andrew Hutson, after reviewing all of the entries in detail against the requirements of the brief, states that the Mitchell/Giurgola and Thorp entry was probably the only one that could have won. For Hutson, ‘Of the other 328 entries, I apologise, but they just did not read the brief’ (Hutson, 2008).

²⁸ Interview with juror John Andrews by Peter Scriver, unpublished.

In the scale of the city, much of the ambiguity of which critics at the time noted was already written into the briefing documents (1979). Hutson eloquently frames this in his summary of the uncertainty of the brief to entrants. The brief both mentions the United States Capital building and the spires of Westminster as examples to which to aspire to in becoming a major national symbol. These buildings as symbols, as Hutson notes, bring different connotations. Secondly, the brief poses a question regarding the scale of the anticipated building. The brief states:

What would be the connotations in the mind of the visitor of a building with a monumental scale sited on the hill? Does significance necessarily mean bigness?

Hutson claims that this is actually not a question, but an instruction to the architects entering the competition. The competition was therefore looking for something which is not like the Capitol in Washington and does not signify bigness in the sense of height and scale. 'It's something which could be informal and romantic and perhaps have an air of grace and simplicity about it', the brief stated. Being in the midst of carefully considering the vistas and approaches to the Capitol building in the Master Plan for the future development of the United States Capitol grounds (1977-81) the question of bigness was foremost in Giurgola's mind.

Following from Kahn, Giurgola's buildings from the 1960s and 1970s were often generated from interlocking plan geometries, although Giurgola found Kahn's unyielding assembly of platonic forms problematic. Contemporary to Parliament House are two examples of Giurgola's use of simple geometries as the building block for the plan, but in other ways the arrangements withdraw from being strictly symmetrical. The Newman Residence (1979) echoes the use of simple geometries displayed in Kahn's Trenton bathhouse (1955) but Giurgola moulded the Palladian derived plan to accommodate a greater variety of room sizes. The Kasperson Residence (1979), a series of interlocked square rooms, is a derivative of Kahn's Fisher House, but a wing comprising of the main living room and an underset porch is oddly splayed. Although there is an enormous difference in scale to the New Parliament House, the relationship to the Newman house is remarkable. Outwardly splayed walls frame the approach to an entry set beyond a heavy set, stripped down

classically proportioned portico, an element picked up again at the Volvo Headquarters. Equally, the combination of square and long vertical openings apparent in both buildings is a feature of Giurgola's designs dating back to the early days of Mitchell/Giurgola of which the White House (1963) is an early example. Despite the different scale these family homes, the use of similar motifs nevertheless indicates a desire to recreate the intimacy and human scale of the spaces in Parliament House as well as a series connected moments that links the spatial elements.

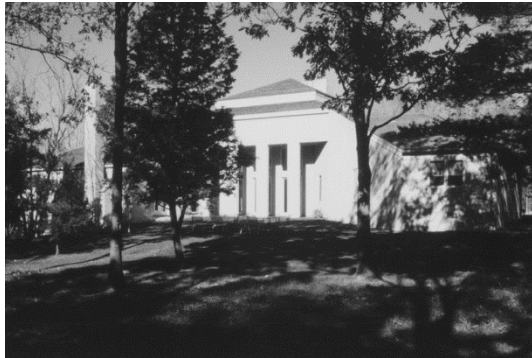

**Figure 4.24: Newman Residence, 1979. Courtesy of The Architectural Archives, University of Pennsylvania.
Ref: aaup 267.II.A.77b**

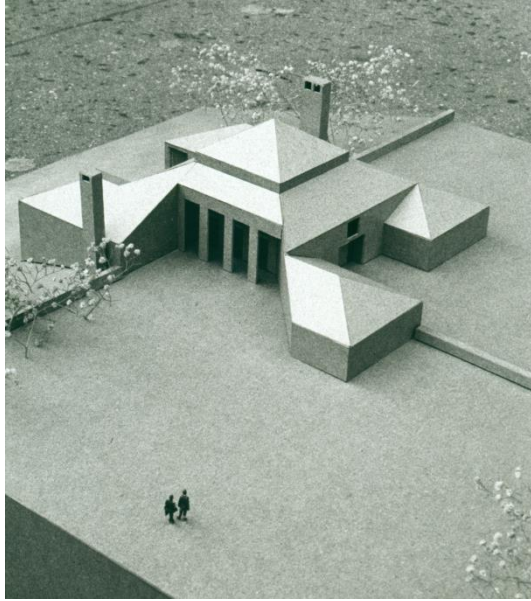

Figure 4.25: Newman Residence, 1979. Courtesy of The Architectural Archives, University of Pennsylvania. Ref: 267.II.A.77a

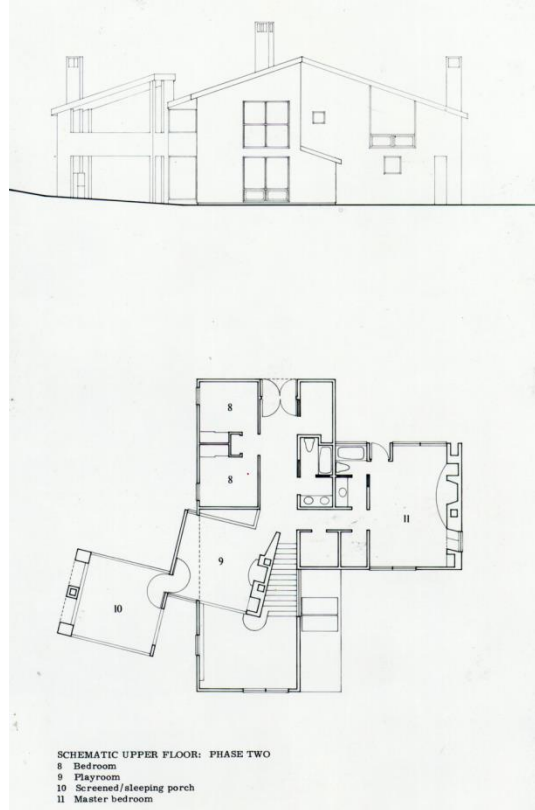

Figure 4.26: Kasperson Residence, 1979. Courtesy of The Architectural Archives, University of Pennsylvania. Ref: aaup.015.V.042.1

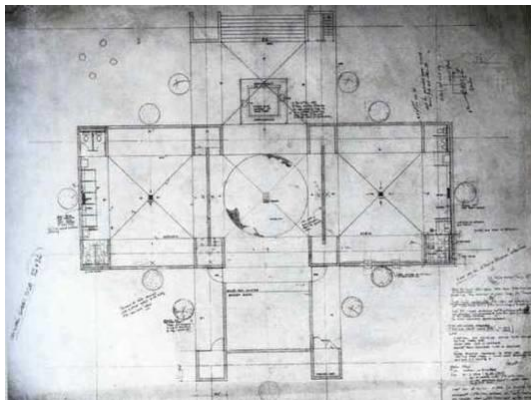

Figure 4.27: Louis Kahn, Trenton Bath House, 1955



Figure 4.28: White Residence, 1963. Courtesy of The Architectural Archives, University of Pennsylvania. Ref: aaup.015.V.131.1

It is therefore questionable whether the ambiguity for which Mitchell/Giurgola and Thorp's design was criticised is aptly aimed, and whether the Post-modern lens hasn't led to a misunderstanding of the intent of some of its motifs. The tripartite elements that adorn the roof for example; the oddly vacant flagpole structure and flanking

pyramidal terracotta roofs over the houses of Parliament do not necessarily fit with the larger diagrammatic plan. Instead of a dominant element, like that of the dome of the United States Capitol, the flagpole structure oddly frames the landscape beyond. In the Post-modern lens the building invites double-coded meanings of giant television aerials broadcasting Parliament's message to the proletariat, rolling green carpet lawns, exaggerated terracotta suburbia, and so forth.

However, as the study of his future buildings in Australia will show, Giurgola's use of oddities in scale, form and materials is a calculated device. In Parliament House, as in Condon Hall with its exaggerated concrete screens contrasted against a bulky, raw concrete volumes, there is a distinct change of scale in Parliament House between bigness (flagpole structure, arcing walls and house roofs) that relate to the scale of the city, and the finer elements (filigree screen of the great veranda); the latter appearing almost model-cardboard-like in the setting of the more city scale elements.

Examination of Aalto's buildings, as in Griffiths's description of the Palazzo form with respect to the Enzo-Gutzeit building discussed in Chapter 3, produce an unsettling character by unexpected junction, exaggerated perspective, and carefully considered perplexity. Like Aalto's buildings, Luigi Moretti's *Il Girasole* features many slight distortions in the building's symmetry and balance, including apparently unsupported masonry and overlaid materials without any apparent ordering system, creating an imprecise, but orchestrated appearance that produces a state of suspension: between support and collapse, between heavy and paper thin rustication, calling the materiality of stone into question. But it is not so much the contrast of the direct contrast of the elements in composition but that they are deliberately 'undecidable', as Peter Eisenman calls them (Eisenman & Harrison, 2008), that makes *Il Girasole* difficult to neatly catalogue into historical and doctrinal context.

For Robert Venturi, Moretti and Aalto were examples of complexity and contradiction. According to Venturi, *Il Girasole* was an example of his second classification of complexity and contradiction, ambiguity, in which 'oscillating relationships, complex and contradictory, are the source of ambiguity and tension' (Venturi, 1966). *Il Girasole* illustrated this calculated uncertainty: 'are they one building or two?' Venturi said. Aalto's buildings, using *Maison Carré* and Baker

House Dormitory as examples, are instances of Venturi's 'The Inside and Outside' wherein interior and exterior are contradictory, disagreeing with the modernist orthodoxy that the inside should be expressed on the outside.

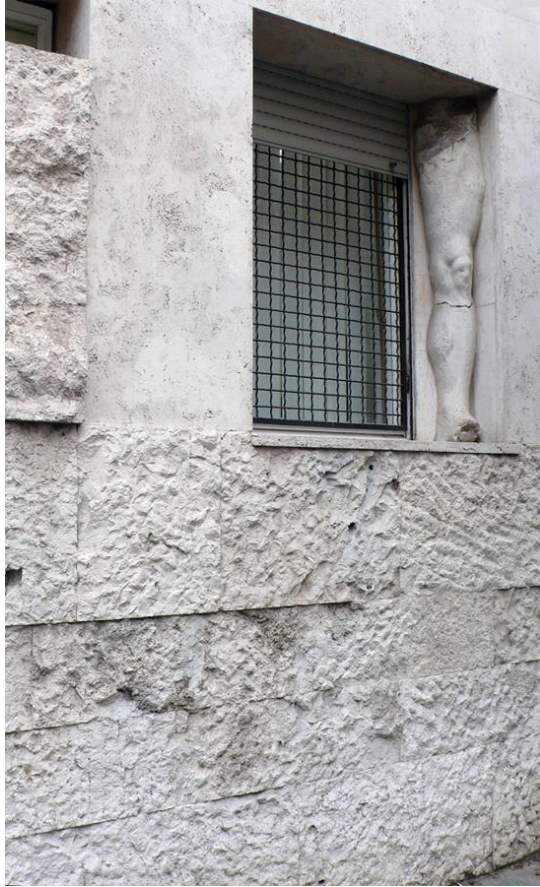

Figure 4.29: The juxtaposition of rusticated and smooth stone and historical references in the base of Casa 'il Girasole', Rome. Photograph by Jacopo Benci (2010). Used by permission.



Figure 4.30: Detail of Alajärvi Town Hall, 1966, Alvar Aalto, showing the irregular overlay of stone veneers. Photograph by Josep Maria Torra (2008). CC BY-SA 3.0.

In Giurgola's New Parliament House it is the indistinctness of scale that Giurgola composes in the building in the context of a designed city overlaid on the natural landscape. Suggestions of the wit and ornament of the post-modern claimed by its critics rather underplays the Giurgola's calculated indistinctness between big and small, outside and inside and buried and carved. The building in many other ways complies with a fairly straight forward answer to its setting in the design of the axial city and the fine urbanity anticipated by the delivery of a New Parliament. It's distinct symmetry, and at the closer scale, where inhabitants come into contact with the building, the finishes are carefully and finely detailed; quite a contrast to the

juxtaposition of materials in the rusticated base of Il Girasole or Aalto's experiments at his summer house or the Alajärvi Town Hall. In these ways Parliament House expresses the effete and refined grand palace rather than the rustic designed ruin of Aalto.

There is also Mitchell/Giurgola's Swedish experience that introduces questions about whether Parliament House is so easily dismissed as simply post-modern. While the conversations with Volvo had begun in the 1970s, it is unlikely that they had a significant bearing upon the initial concepts for the first stage competition entry for Parliament House. Nevertheless, the reconstruction of Giurgola's personal story reveals his larger context, particularly his re-visitation of Italy through the Friuli commissions. Tombesi credits Giurgola's formative experience in Rome, his 'Roman Habitus' for his mature approach in America and Australia, claiming that his arrival in the United States was more a development of an already defined trajectory (Tombesi 2000). Giurgola's formative experiences were carried forward, but the development of such motifs as the tiled Parliament House roofs are visual reminders of the qualities of regional Italian architecture in the 1970s. Through an amalgam of historical and symbolic references, and distortions of scale and materials, Giurgola touches on that threshold about which a shift from one reading of the building to another occurs, and hence codes the building with allusions of 'home', 'citizenship' and 'land'; his 'constants', whilst acknowledging that technology was an actuality to which Christopher Alexander's 'timeless way' could not fully respond. On the other hand Giurgola's encounter with Sweden led to other productive outcomes that informed the design's development and delivery. Giurgola translated many of the ideas fostered at Volvo, particularly the art program and the concept of the building-as-villa paradigm, as will be discussed in later chapters.

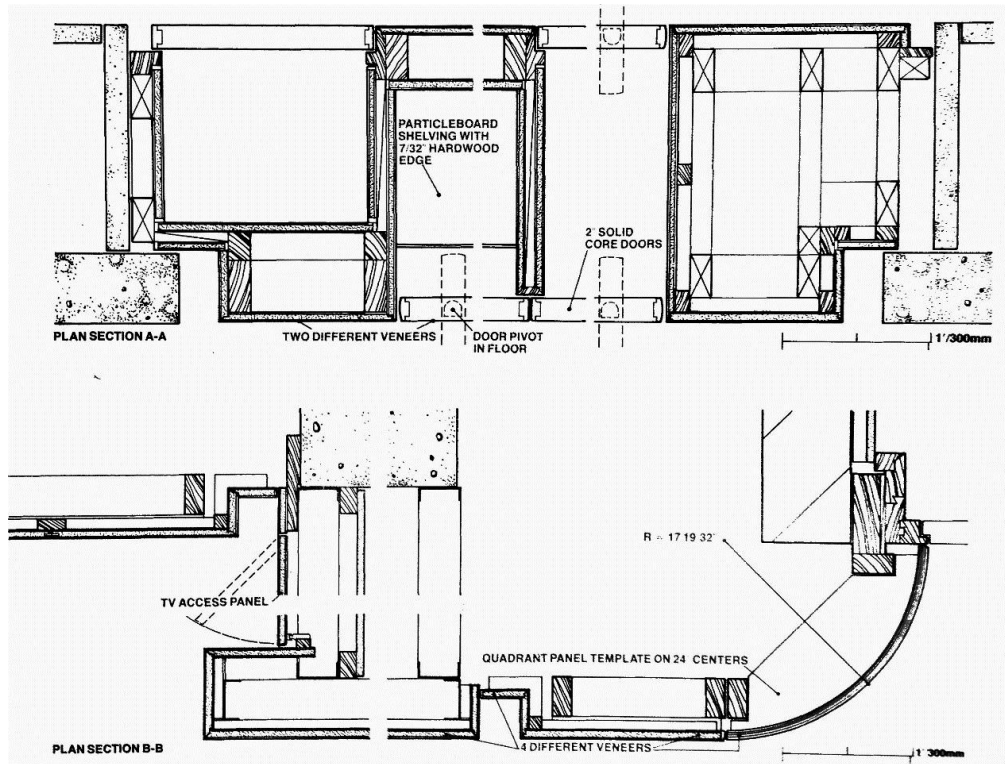

Figure 4.31: Details of Parliament House interiors, showing the delicate composition of pre-cast concrete, timber and plasterboard walls. Murphy (1988)

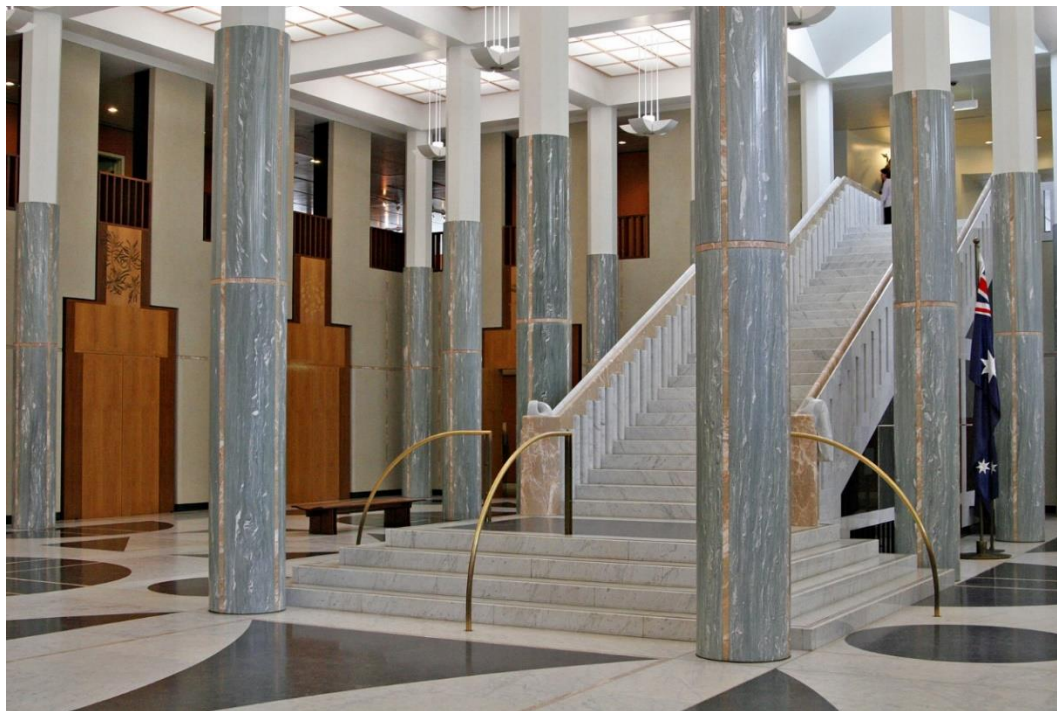

Figure 4.32: New Parliament House interior showing the highly composed arrangement of stone and timber veneers. Photograph by Fir0002/Flagstaffotos. CC BY-SA 3.0.

Postscript: After Parliament House.

By the end of the 1980s, despite two decades of success in the United States and internationally, Mitchell/Giurgola suffered a series of setbacks after the Parliament House competition. In 1989, Giurgola was commissioned by the new director of the Kimbell Art Museum, Dr. Edmund Pillsbury, to make an addition to the architecturally revered Louis Kahn building. In his design Giurgola recommended building precise replications of Kahn's vaults at either end of the long building. The literal reproduction of Kahn's design was defended by the architect and the museum's director as homage to the original architect, but publicly attacked by many of the project's critics as vulgar mimicry that would blur the distinction between Kahn's masterwork and the later additions. Architectural 'big guns' such as Philip Johnson, Frank Gehry, Robert Venturi, James Stirling and Richard Meier signed an outraged letter to the Kimbell board and New York Times calling the proposal a 'mimicry of the most simple minded character' (Koerble, 1990).

In January 1990 Giurgola and Dr. Pillsbury travelled to New York to argue in favour of the scheme at a symposium sponsored by the Architectural League. But at the sold-out public event, which attracted architects I. M. Pei and Robert A. M. Stern, the architectural historians Vincent Scully and Kenneth Frampton, as well as the architect's widow, Esther Kahn, no one except Giurgola and Dr. Pillsbury spoke in favour of the scheme. Architects and critics denounced it, with Kenneth Frampton going so far as to say that Giurgola's plan was 'petit bourgeois' (Swartz 1990). The expansion of the museum was eventually cancelled until 2007 when an addition was announced, to be designed by the accomplished museum architect Renzo Piano. In the 1960s, Piano worked briefly in Kahn's office. The new pavilion, opened in 2013, was designed in careful deference to Kahn's masterpiece (Rybczynski 2013).

It was also a personally difficult period for Giurgola. Ostensibly, Giurgola's choice to remain in Australia was based on his love of Canberra and Australia, but for him personally, the end of the 1980s his wife Adelaide had begun to show the first signs of Alzheimer's disease, even before he won the Parliament House competition (Giurgola 2002). In the late 1980s the small family moved to Arkana Street in Yarralumla where Giurgola had bought a 1967 modernist style house designed by Noel Potter of

Bunning and Madden. In the intervening years Adelaide had deteriorated, regardless of the care from Giurgola and their only child, Paola (a librarian and artist who moved to Canberra to be with her mother). Robert Thorne, an architect in Mitchell/Giurgola Thorp's office in Canberra close to Giurgola, recalled that Adelaide's illness was a significant influence on his decision to remain in Canberra, away from the busy streets of New York or another Australian metropolitan centre (Thorne, 2002). Adelaide died in Canberra in 1997.

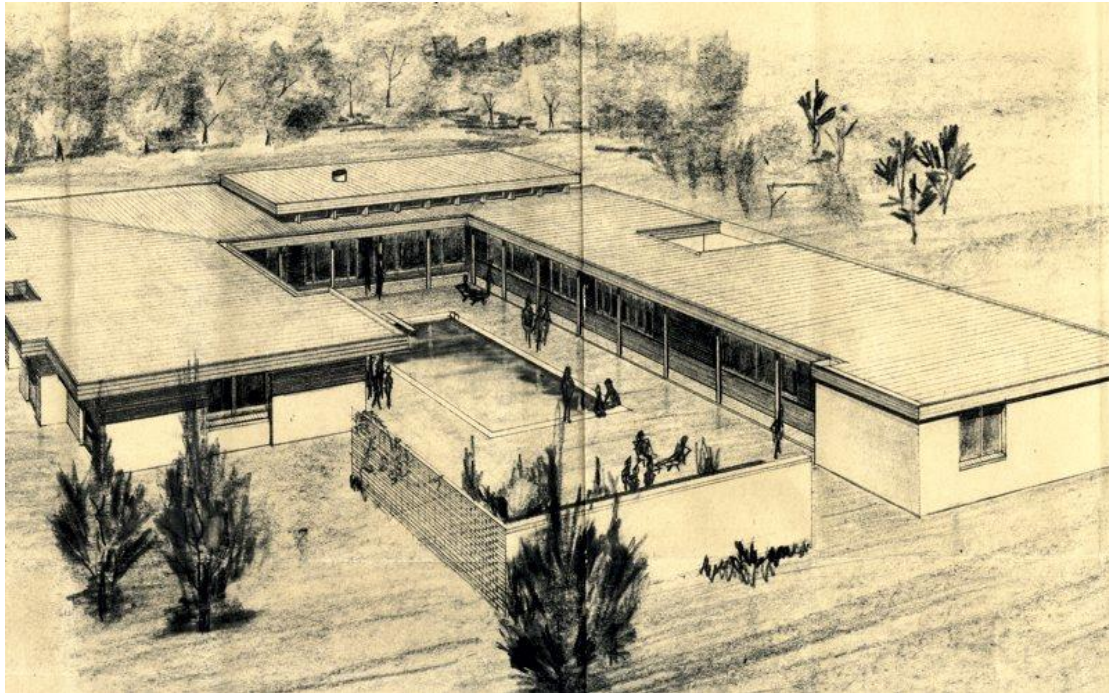

Figure 4.33 3 Arkana Street, Yarralumla, designed by Noel Potter of Bunning and Madden in 1967. CC BY-SA 3.0.

Giurgola retired as a partner in the office of Mitchell/Giurgola and Thorp in September 1999, aged 77, but retained a drawing board on the floor of the newly formed MGT Architects and a private office so that he was able to keep working on select treasured projects, the most prominent of which was the St Patricks Cathedral. In this way he was able to retain the resources of the office and a core group of architects that he had worked with for many years. Following a restructure of the partnership that concluded with the split of the Sydney and Canberra components, Giurgola left MGT Architects along with long term colleague Pam Berg and opened the very first office of 'Romaldo Giurgola Architect' in 2004.

Being progressively set apart from the profession as one of its wise elders, and in the context of a not yet fully realised fringe Capital, Giurgola produced some of his finest work on the margins of contemporary architectural polemic.

Chapter 5 Downsizing: St Thomas Aquinas Church, Canberra (1986–91)



Figure 5.1: St Thomas Aquinas Church, Charnwood, Canberra. 1986–91. Photograph by John Gollings © Guida Moseley Brown Architects

Introduction

Giurgola's St Thomas Aquinas Church of 1986-91 (See Figures 5.1-5.7) is located in the Canberra suburb of Charnwood, on the outskirts of the Australian Capital Territory. The suburb was established in 1973 as Canberra expanded to the north and south, outside of the extent of the Griffins' Canberra Plan, in planned satellite towns corresponding to the uptake of the motor car as the main form of transport in Australia. Its layout was based on the modern garden suburb model, founded on the 'Radburn' model, an offshoot of the English garden suburb and designs emanating from America. Building lots were arranged in cul-de-sacs connected by collector roads and were expected to be filled with single family homes. Each suburb was serviced by a group of shops, schools, recreation space, and one or two low-slung public buildings clustered at the highway exit. At Charnwood, between a fast-flowing highway and a collector road, is a strip of shops, fast-food restaurants and land for

community use. The latter land parcel saw the development of a Catholic community school and presbytery, constructed sometime in the 1970s, a collection of ordinary institutional educational structures with scant architectural merit. It is the latter building to which Giurgola appended the church.

Giurgola's church is around 500m² of building and 250 m² of external works, intended to accommodate 400 people. Built with scant resources²⁹, its painted brick and tiled raking roof are materials and forms of the suburban churches constructed during the 1970s to 1980s in Canberra. And yet, like the preceding parliament building, the church building responds to its context in unexpected ways.

When viewed from the East, along Lhotsky Street, the St Thomas church bears an uncanny resemblance to Alvar Aalto's Villa Carré. Robert Thorne (2002), who worked directly with Giurgola on the roof design commented that Giurgola's technical resolution of the long skillion roof was derived directly from the Aalto house. In the Villa Carré, in order to reduce the amount of roof water collecting at the low edge of the skillion, Aalto used an interwoven pattern of gutters. According to Thorne, the same solution was attempted for St Thomas but cost pressures resulted in the series of stepped skillions (see Figures 5.2 and 5.3), still not dissimilar to the pattern of roofs in the Villa Carré.

²⁹ Construction cost of the church cost was estimated at \$600,000. The monetary figure does not include work and materials contributed by the congregation members. Nevertheless it was a considerable undertaking to produce a building that could accommodate the program with the resources available. It has also been suggested that Giurgola provided a significant portion of his architectural service *ad honorem*.



Figure 5.2: Lhotsky Street (north) Elevation, St Thomas Aquinas. Photograph by John Gollings © Guida Moseley Brown Architects



Figure 5.3: Maison Louis-Carré, Alvar Aalto (1956—1959). Photograph by Maurizio Mucciola. CC BY-NC-ND 2.0. https://www.flickr.com/photos/maurizio_mwg/16019374266/in/photostream/

This chapter will examine the church through two lenses: the context of Giurgola's personal development; and a formal analysis of the architecture of the building. The analysis is informed by original documents sourced from the Mitchell/Giurgola and Thorp archives and from interviews conducted with Giurgola, other members of the office, and the client. While it is impractical to try to completely untangle the formal influences in the work such as those of Aalto, the analysis component of this case study of the St Thomas church interprets the object itself with the aim of uncovering themes that are not obvious at first impression: those which bind what might seem like eclectic array of influences in Giurgola's architecture into a pattern of consistently applied strategies related to those of the other tradition. Also, it will provide insights into the transition of Giurgola's work at the time of his arrival in Australia. It is not simply that Giurgola composed the building to directly contradict familiar concepts in western architecture, or indeed modern church architecture, but rather it is the way in which the building fuses with the site, responding to what Baker terms its *site forces*. The site factors, amongst others, I hope to show inspired Giurgola's design. The fact that he worked on the design largely alone (Giurgola 2002) is also relevant, and is discussed further.

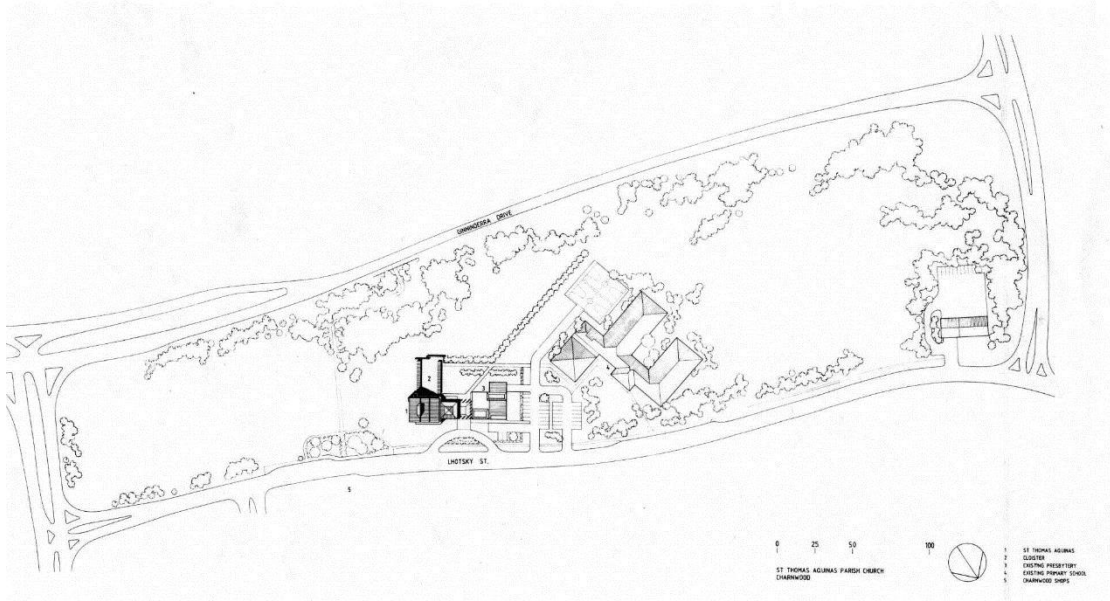

Figure 5.4: St Thomas Aquinas Site Plan. Guida Moseley Brown Architects

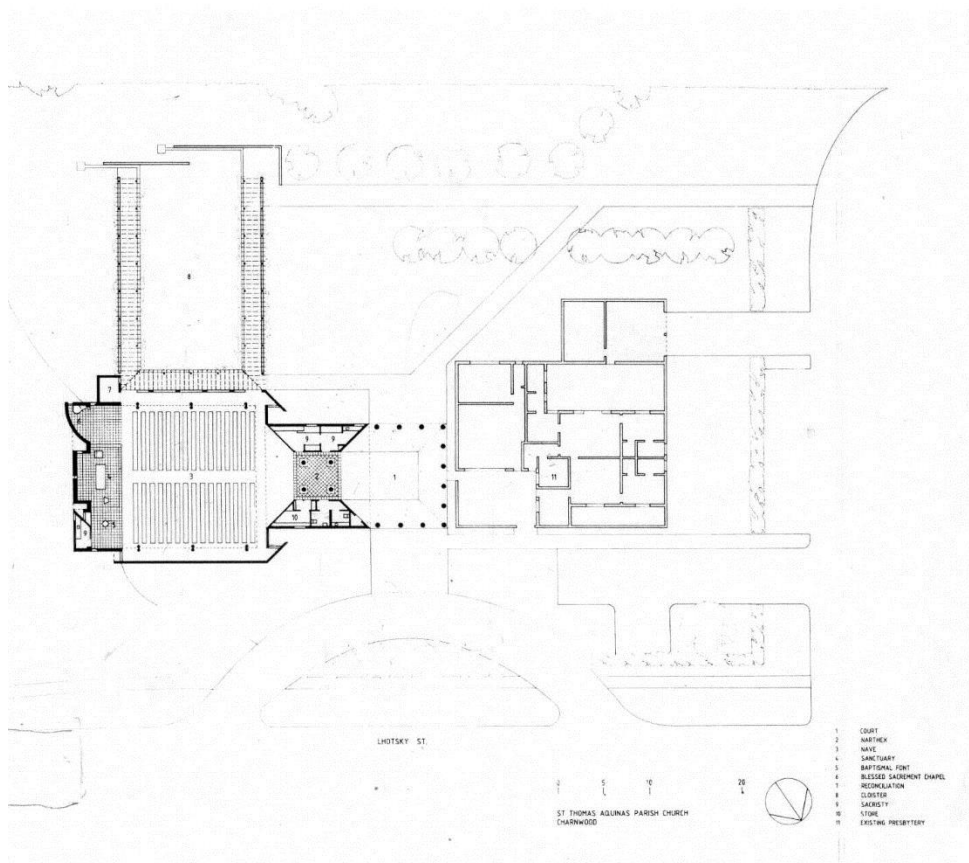

Figure 5.5: St Thomas Aquinas Plan. Guida Moseley Brown Architects

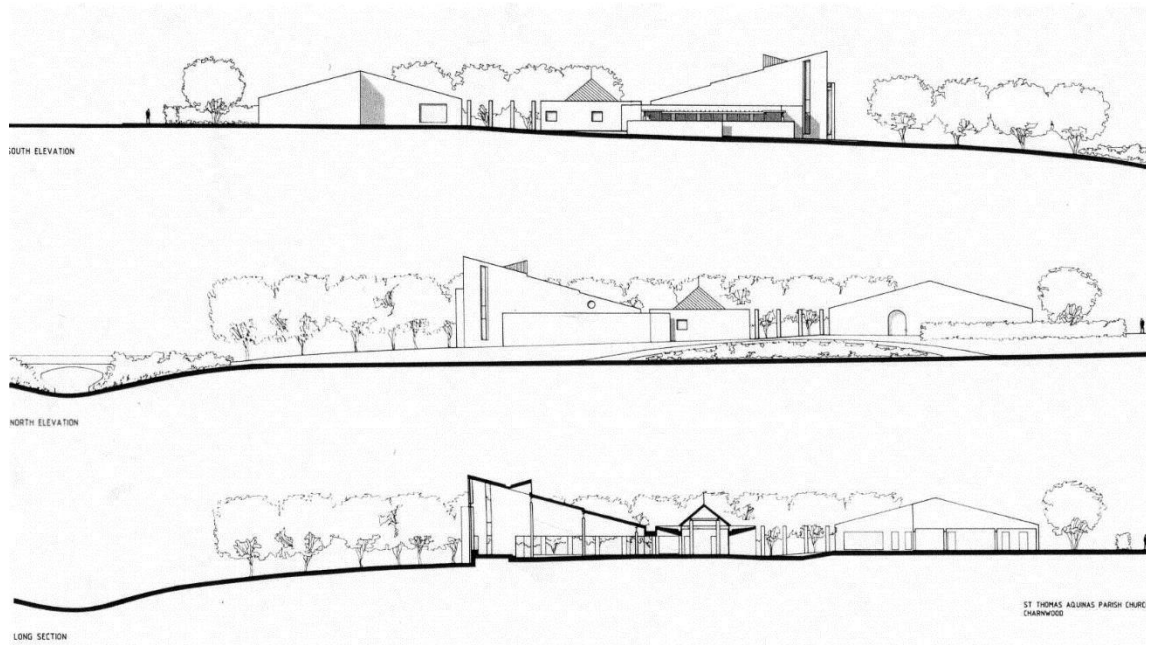

Figure 5.6 St Thomas Aquinas Elevations and Long Section. Guida Moseley Brown Architects.

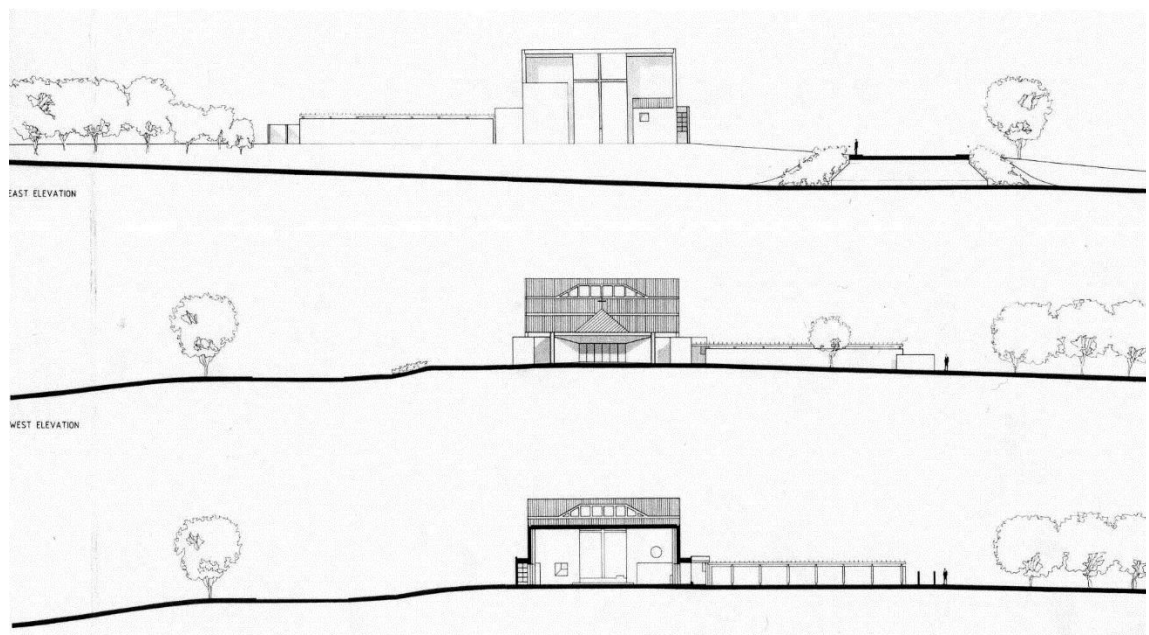

Figure 5.7: St Thomas Aquinas Elevations and Cross Section. Guida Moseley Brown Architects.

The most expensive architect in Australia

By 1986, when Parliament House was nearing completion, Mitchell/Giurgola and Thorp, had not secured further government work of any significance in Australia. There were expectations that commissions would follow from Australian governments or other large institutions. Giurgola (2002) was surprised by the lack of calls, but, he claims, he had not actively sought more government work. The lack of substantive work left Giurgola, his partners, and a considerable number of staff (some 200 at its height) in a tenuous situation. With Giurgola at almost 70 years of age, reform was the obvious conclusion for the company.

The first contact between the Charnwood parish and the Mitchell/Giurgola and Thorp office occurred in 1986. Before Giurgola knew of the upcoming development, Father Drinkwater and a steering committee of the Charnwood parish had advertised and interviewed local architects, and reviewed the submission of sketch proposals. When the process was almost complete Giurgola probed for inclusion. Thorne (2002) and Drinkwater (2002) recall that Giurgola had actively pursued the commission.

As Giurgola recalls it, the Charnwood priest, Father Drinkwater, appeared at the Mitchell/Giurgola and Thorp office in Manuka requesting a meeting with Australia's 'most expensive architect' (Giurgola 2002). During the meeting, Drinkwater's central queries concerned Giurgola's fee and his capacity to keep the project within budget. It is difficult to imagine that Drinkwater who Pam Berg later described as 'a man of simple faith' (Berg, 2007), would have approached the renowned architect for the design of the tiny parish church without Giurgola's solicitation, but the first official meeting may well have occurred in the way Giurgola describes. While the negotiations continued, and later during the project, Giurgola and Berg occasionally attended mass at the school hall where the parish met for services (Thorne 2002).

Meanwhile, the younger generation of architects in the Canberra office, some of whom like Giurgola had made Australia their permanent home, became more assertive. Hal Guida, appointed partner in charge of design coordination of the parliament building, grew further in stature in the Canberra office through later projects such as the ANA Hotel, the ACT Legislative Assembly and the University of the Sunshine Coast. Following Parliament House, Giurgola also worked separately on

large-scale projects like the Singapore Armed Forces Training Institute (SAFTI) but by the 1990s Guida had emerged as the principal designer in the office. The SAFTI project also established an ongoing push into South East Asia and China for the Canberra office of Mitchell/Giurgola and Thorp.

SAFTI, shown in Figure 5.8, was a large complex of buildings that included training facilities for all codes of the Singapore armed services, barracks, and administrative buildings. The predominant use of brick cladding, along with truncated arc openings, rhythmical galleries and exposed concrete lintels, is strongly reminiscent of Kahn's Indian Institute of Management, Ahmedabad. However, in contrast to Kahn's austere building, Giurgola roofed the SAFTI with pavilion-like roofs of terracotta tiles, evoking Asian temple typology. The SAFTI complex of buildings was completed in 1995 but has remained obscure.³⁰

There was also a view to expand Mitchell/Giurgola and Thorp to a wider market within Australia in the late 1980s. In 1989, a Sydney office of Mitchell/Giurgola and Thorp opened under the direction of Richard Thorp. The stimulus to open an office in Sydney was provided by two projects: an architectural competition for the multi storey ANA Hotel (completed 1992), won by a Hal Guida design; and a smaller commercial project in the Rocks area.

By the end of the 1990s, the Sydney office would overtake Canberra for local work but until then it remained an outpost of the Canberra office. Giurgola travelled to Sydney mentoring young architects like Richard Francis-Jones, who had joined the Sydney office almost from its inception. He was said to have been taken under Giurgola's wing (Brooks, 2007). Francis-Jones was later to be an influence on the direction of architectural development in Sydney through teaching and public life³¹.

³⁰ SAFTI was not published widely in architectural journals outside of Singapore.

³¹ Richard Francis-Jones is currently a partner in the Sydney practice, Francis-Jones Morehan Thorp Architects (formerly MGT Architects, Sydney). He is a visiting professor at the University of New South Wales and was president of the NSW Chapter of the Royal Australian Institute of Architects, 2000–2002.

Giurgola's mentoring role, however, did not include the St Thomas Church. Clearly, it was a project that was close to his heart and one which he developed alone, for feedback consulting with architects who worked directly on the building or with Pam Berg.

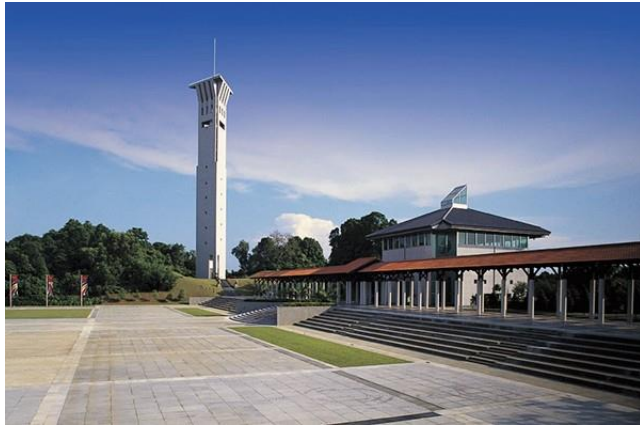

Figure 5.8 SAFTI Military Institute, 1990—1995.

http://www.mindef.gov.sg/content/imindef/mindef_websites/atozlistings/saftimi/about_Us/photos/_jcr_content/imindefParents/image.img.jpg/1429683818293.jpg

Concluded, or even *démodé*³²

St Thomas Aquinas church did not feature widely in publications of the time. The main piece about the church was published in *Architecture Australia* after the opening of the building in 1991. Its author, Nigel Westbrook (1991), wrote of the 'dilemma of authenticity' faced by the Church in contemporary Australian suburb building of the 1970s and 1980s, and compared Giurgola's church to other recently completed churches by Greg Burgess and Peter Corrigan.

Westbrook saw Giurgola's church as a reaffirmation of the Church's cultural role in the urban structure, praising Giurgola's skill in pulling together 'fragments' of historical references into an understandable itinerary of experiences that 'aspire to a whole.' Westbrook focused attention on the church's formal expression, particularly

³² Guido Canella (1977) speculating on the reasons why the 'third generation' modernists were not more widely published.

Giurgola's adherence to historical continuity. He noted that, '... a series of specific interrelated parts is strongly reminiscent of a monastic complex'.

Westbrook also commented on the abstract mythical themes he found within the design, declaring that,

*The columns of the atrium bear the sky as fragments of a lost order.
Their form is reduced to twelve 'rough-hewn' logs, ostensibly an
anthropomorphic representation of the apostles, but equally
plausibly a reference to the rustic tradition of the sacred grove,
guarded by wood gods.*

Further, and of relevance to this study, he notes the building's Nordic antecedent, stating that the mono-pitch roof inflected up towards the performance is in a manner reminiscent of Aalto's late work. In conclusion, Westbrook finds that Giurgola's work is 'both a truly modern and historicist work' (1991).

Giurgola's St Thomas Church was published five years later in 1996 by the Italian journal *Zodiac* as part of a celebration of the journal's 30th year. Its central essay, by Guida Canella, reviewed the work of architects of a 'third generation'³³ of Modernists, those born around 1920. Canella supposed that this is what Sigfried Giedion had intended by his essay 30 years earlier in the first issue of *Zodiac* (1965), in which he announced 'Jørn Utzon and the third generation'. Canella expressed doubt that Giedion's characterisation of a 'third generation' described a shift in poetics, but noted that 'in a synoptic context, the identification of certain

³³ Guido Canella, (1996) listed the European and American entries of this third generation as: Peter Blake [United States], Eduardo Catalano, [United States], Alan Coquhuon, John Miller [Great Britain], Marcello D'Olivia, Mario Fiorentino [Italy], Ulrich Franzen [United States], Yona Friedman [France], Ernst Gisel [Switzerland], James Gowen [Great Britain], Vico Magistretti, Angelo Mangiarotti [Italy], Claude Parent [France], Leonardo Ricci [Italy], Kevin Roche, John Dinkeloo [United States], Paul Rudolph [United States], Alison and Peter Smithson [Great Britain], Paula Soleri [United States], Jorn Utzon [Denmark], Aldo van Eyck [Netherlands], Vittoriano Vigano [Italy], Colin St. John Wilson [Great Britain] (Canella, 1996)

characteristics of one generation, if carried out with a certain elasticity, can contribute to a clarification of the evolution of taste' (Canella, 1996). He pointed out that although it was this generation of architects that set about building the modern vision, their work did not achieve the same attention as the heroic generations that preceded it. He concluded that, by the 1980s, their work was regarded as outdated.

On the other hand, Edmond and Corrigan's Chapel of St Joseph, Box Hill North (1976) and Greg Burgess's Church of St Michael and St John in Horsham (1987), received much wider coverage. Recalling lessons from Robert Venturi and, for Burgess, the teachings of Christopher Alexander, these churches overtly repurposed architectural language from the suburbs. Reviewer of Burgess's Horsham church, Harriet Edquist (1988), reflected that,

Burgess's formal sources are, like his thought, far more varied. The European traditions on which he appears to draw are not derived from the so-called "rationalists" like Le Corbusier and Mies. They are...more in tune with the organic and empiricist traditions – Art Nouveau, Steiner, Saarinen, Utzon and Aalto.

That Giurgola's church of St Thomas was so lightly covered by critical review, once in Australia at the time, and later in Italy, suggests that the building was considered a footnote work by an ageing and passé architect.

The design of St Thomas

Giurgola was not a noted architect of ecclesiastical buildings prior to the St Thomas commission. Despite the considerable reputation enjoyed by Mitchell/Giurgola for public buildings the St Thomas Church was only Giurgola's third opportunity to design a religious building. In 1965 Mitchell/Giurgola designed a church and school in Swarthmore, Pennsylvania. The project was never built. Eight years later he designed an assembly building for the Benedictine Society of St Bede (1973). Its planning and three dimensional forms bear the hallmarks of Louis Kahn: 'servant' and 'served' rooms, a geometric plan assembly, and the use of controlled natural light through high level openings. By this time in his career, the 45 degree angle in plan,

deployed again in this example shown in Figure 4.9 and Figure 4.10, had become a Giurgola signature.

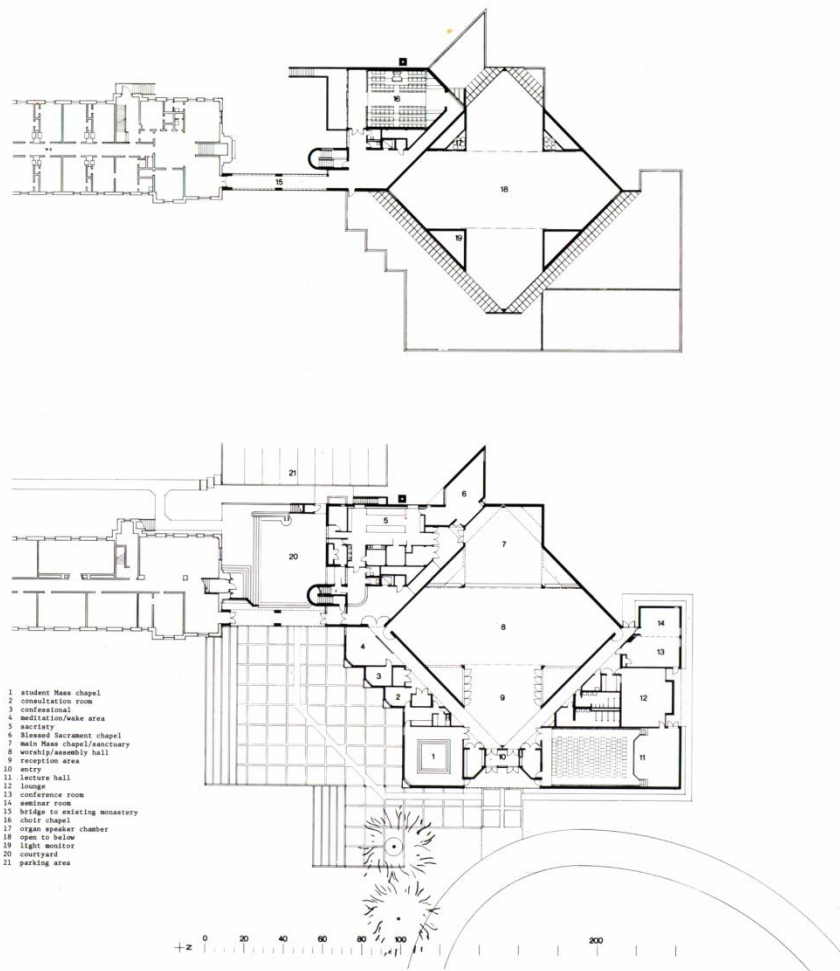

Figure 5.9: Plan of Worship Assembly Building, Benedictine Society of St Bedes, 1973. Courtesy of The Architectural Archives, University of Pennsylvania. Ref: aaup 267.II.A.22a

It was not, then, until late in his career that Giurgola had the opportunity to design a stand-alone church. In July 1986, after gaining the commission, while en route to Los Angeles, Giurgola wrote a letter to Pamille Berg in which he described his first thoughts for the suburban church. The letter is a detailed reflective conversation, communicating to himself and Berg, the development of the key underlying concepts of his design.

Through diagrams and notes, the pages reveal his inner reflection. The first page is dedicated to the intended function of the building. Giurgola identified ‘assembly’ as the prime motivating force in the planning. He explored the relative position of actors

in the scene and their movements when performing church rites. He commented, 'I began with the assembly of people around an altar ... assembly is the place, the first gesture towards form' (Giurgola, 1986).

The two elements in his first three diagrams (reading left to right) were indicated by the notes as, the assembly and, (indicated by the star) the altar or centre of liturgy. By the fourth diagram, and one could say implicit in the symmetry of the others, Giurgola had introduced a third element, a line indicating an axis running through the centre of the seating and the altar.

From the plan arrangement Giurgola moved his discussion to the points of focus in Catholic worship: the altar, 'where the action of man takes place', and the Chapel of the Blessed Sacrament, 'a fixed place, where the repository of the body of Christ is located'. With a single line diagram he described how he imagined their qualities and relation to the assembly, in a narrative. The assembly and altar were delineated from the exterior: the sacred from external or 'earthly' forces.

Giurgola continued to experiment with the nature of the line, as either open to the exterior or closed, the inflections and depth of which suggest the qualities he envisioned for those activities. The altar is shown as open to the audience, (denoted as 1. in Giurgola's diagram) whereas the chapel is expressed as pocketed and secluded. As the experimentation progressed the fluidity of the line disappeared and the corners were made acute, suggesting architectural intent. In the final sketch of the first page Giurgola extruded the line to a surface. On the following page, he described the surface as a wall folded around events and wrote, 'it receives its configuration from its use.'

Moving to the second page of his letter, Giurgola described two elements of accommodation, 'A', the roofed space or place of assembly and a new element, 'B', the cloister, 'open to the sky'. The wall resulting from his narrative sequence moves through 'A' and 'B'. He proposed a glass interface between the two to allow a visual connection from one to the other and a source of natural light to the assembly space. Giurgola noted this as a reason for placing the cloister adjacent to the assembly.

Giurgola continued by adding a human figure to the diagram, giving scale to the form. So the surface, as an extrusion of the line, implies movement for the figure in his diagram. The penitent moves from the outside world, through the cloister and inside the enclosed space; from event to event created by the undulations and breaks in the wall surface.

The figure is also asked to 'view' where Giurgola cut an opening in the wall. It seems from this instruction, indicated by an arrowed line, that he is asking the figure to contemplate the outside world as he travels along its surface. Perspective diagrams on the second half of the page further explain how Giurgola imagined this path as the Catholic 'Stations of the Cross'.

At this point in the letter (Giurgola 1986), his commentary turned to the nature of the light that he imagined for the spaces, with particular reference to the narrative wall and foci. 'The focuses [sic] are made clear by light...are the light in a literal sense' (Giurgola, 1986). Giurgola's purpose is to highlight the objects of the space. 'It should be real because of the things it touches, giving life to each of them. Walls, floors, tables, plants ...'.

On pages four and five of the letter Giurgola moved to the possibilities of form. He dedicated a significant part of the remaining sketches in the letter to the qualities of the back-drop wall. The influence of Jørn Utzon's Bagsværd Church (1974) is clearly evident in Giurgola's outline for the architecture of the building: simple volumes rising in height towards the centre of worship; flanking glass roofed aisles; and a narrative leading the patron through a series of courtyard spaces from green cloister to an enclosed main worship space.



Figure 5.10: Bagsværd Church, Jørn Utzon, 1968—1976. Photograph by Jonathon Reike, 2012.
<https://www.flickr.com/photos/jonathanreike/8755939173/in/>

Giurgola's reflective conversation expressed in this letter was an attempt to resolve issues similar to those faced by post-war church architects following the Second Vatican Council in 1962–1965. Previously the design of sacred spaces had relied on tried and true symmetry around a processional axis combined with light from above in order to create a sense of the sacred. Of particular importance to the design of churches from the 1960s reformation onwards was a shift from the viewpoint of the clergy to the viewpoint of the people. The key concepts of Giurgola's response to this design problem, expressed in his letter to Pam Berg are fourfold: the resolution of the plan with a collective worship ideology; the narrative in Catholic worship; the expression of materiality through the control of natural light; and an architecture inspired by Utzon's achievements at Bagsværd.

In the final diagrammatic plan on the second page, Giurgola makes the connection with site and context. The existing presbytery is shown dotted on the plan indicating the relative location of the new church. The lack of context in the preceding sketches may be the result of Giurgola's isolation while making them, but more likely points to a desire of gaining a tangible representation of his conceptual thoughts around the experiences of the church-goer before overlaying them on the site. Later references to the presbytery are shown on page four, in elevation, and on five, in a perspective drawing in which Giurgola sees the form as a component of the composition.

Other early sketches for the layout show Giurgola's experiments with Kahn-like geometries, from which an association can also be drawn between the planning of

Giurgola's planning and Kahn's 'servant' and 'served' rooms. These divide a program into a duality: spaces of greater importance, which are treated distinctly, and typically expressed by their location in the centre of the plan, elaborate interiors, high ceiling heights, and a sophisticated expressed structure. Spaces of lesser importance have lower ceilings, basic interior finishes, and simple structure. These lesser spaces are clustered around the central chamber so that the space of central focus is penetrated only through its flanking service rooms. Kahn's realisation of this strategy can be seen at the First Unitarian Church of Rochester completed in 1959 (Goldhagen & Kahn, 2001).

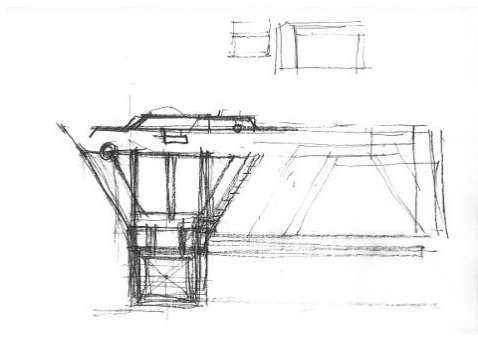

Figure 5.11: Sketch for St Thomas Aquinas Church, 1981.

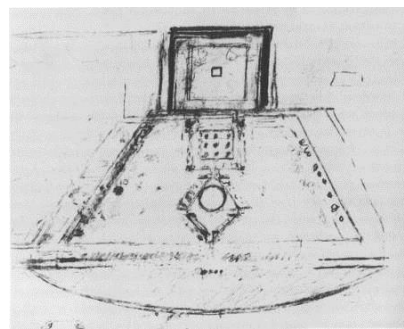

Figure 5.12: An early site plan by Louis Kahn for the National Assembly complex, 1963. Published in (Goldhagen and Kahn 2001): and taken from North Carolina State Student Publication of the School of Design 14 (May 1964).

The extent to which Giurgola had taken ownership of the project is revealed at the end of the letter by his apology to Berg for formulating the sketches without her comment. (See Figures 5.13–5.16)

dear Pam, this are rather premature thoughts, undisciplined about the Church. They are only to share with you. There are in it assumptions which are probably arbitrary and only discussion with Father D. and the community will clarify them. I began from the assembly of people around the altar - I don't know if it is the right point to start - but I thought that the assembly is the place, the first gesture toward form.

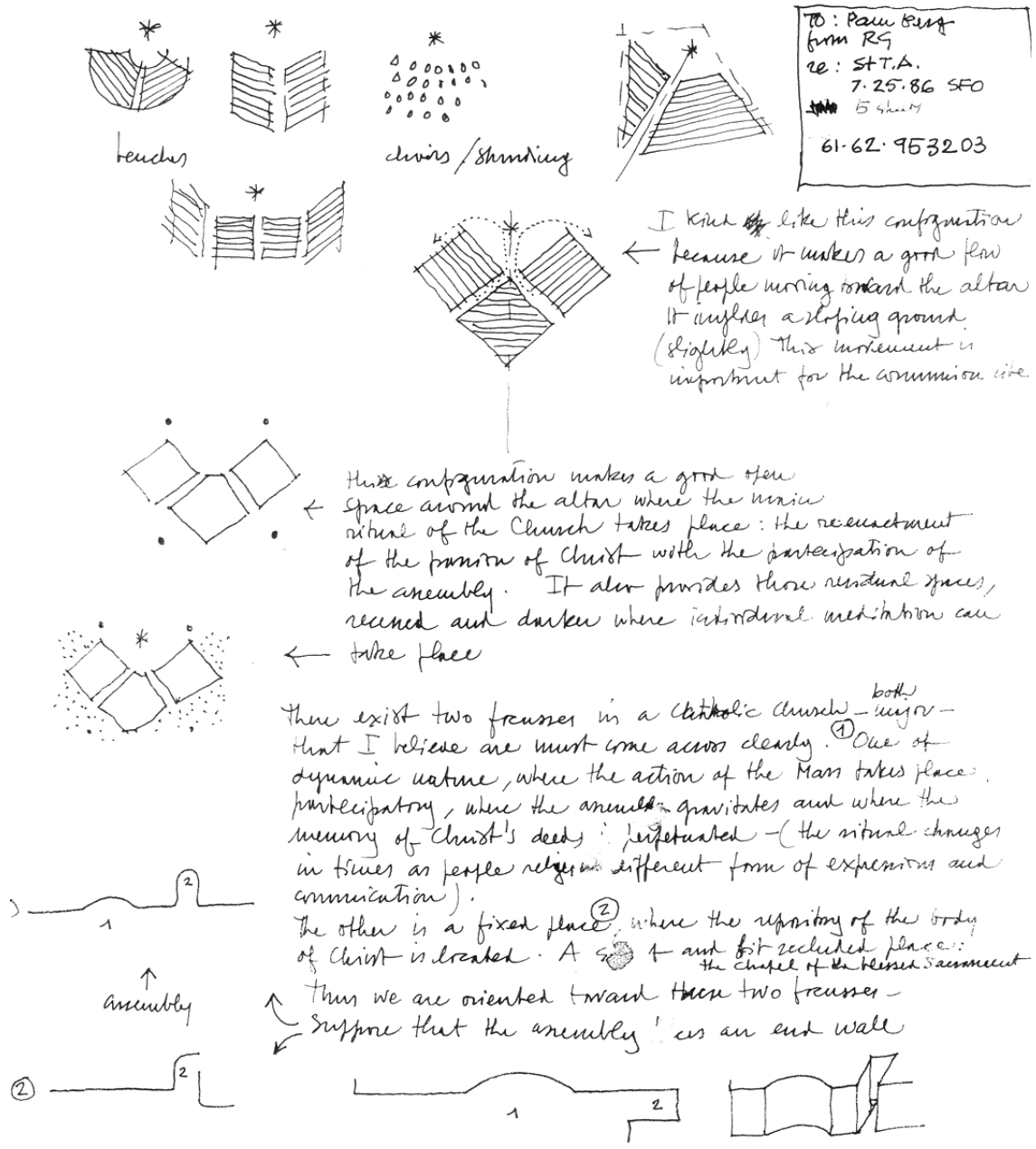
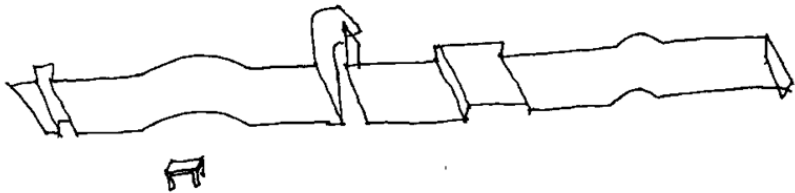
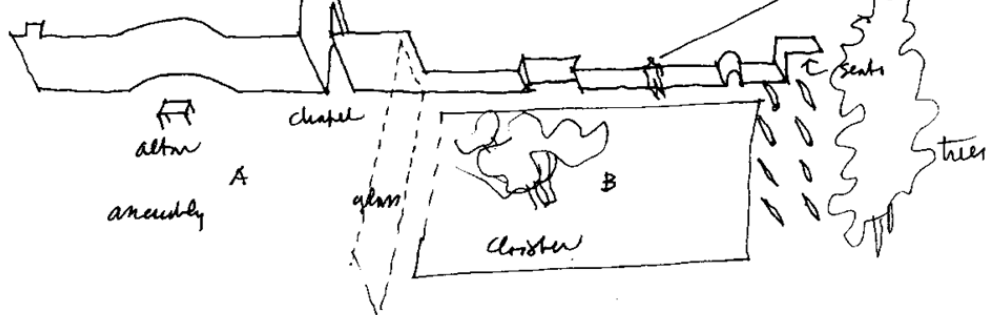

Figure 5.13: Romaldo Giurgola, Page 1 of 5, Facsimile to Pamille Berg dated 25/7/1986. Reprinted with permission from Pamille Berg and Romaldo Giurgola



this wall could be very important as it
receives its configuration from its use - It could extend from inside to
outside - The assembly is roofed - the chister B is open to sky



The focuses are made clear by light. The focuses are the light
in a literal sense, light in its different shades is the main structure
both in celebrative and intricate moments. The wall should have
light: where things
happen and where memories
are placed.

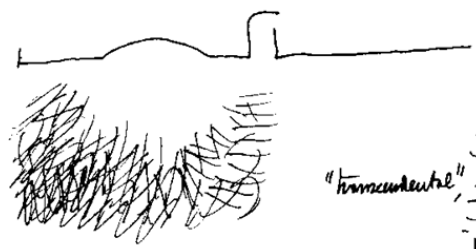

what kind of light? not
If it is natural it should be used
"fundamental" abstract even if its source is hidden.
It should be real because of the things
it touches, giving life to each of them.
walls, floors, tables, plants - - -

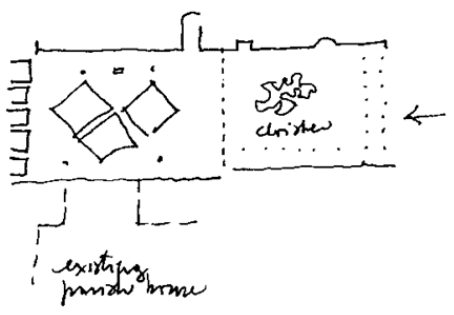

It should be tangible through the perfected
elements of nature. That is why
I am thinking of a chister adjacent
to the assembly
A plan begins to take shape

Figure 5.14: Romaldo Giurgola, Page 2 of 5, Facsimile to Pamille Berg dated 25/7/1986. Reprinted with permission from Pamille Berg and Romaldo Giurgola

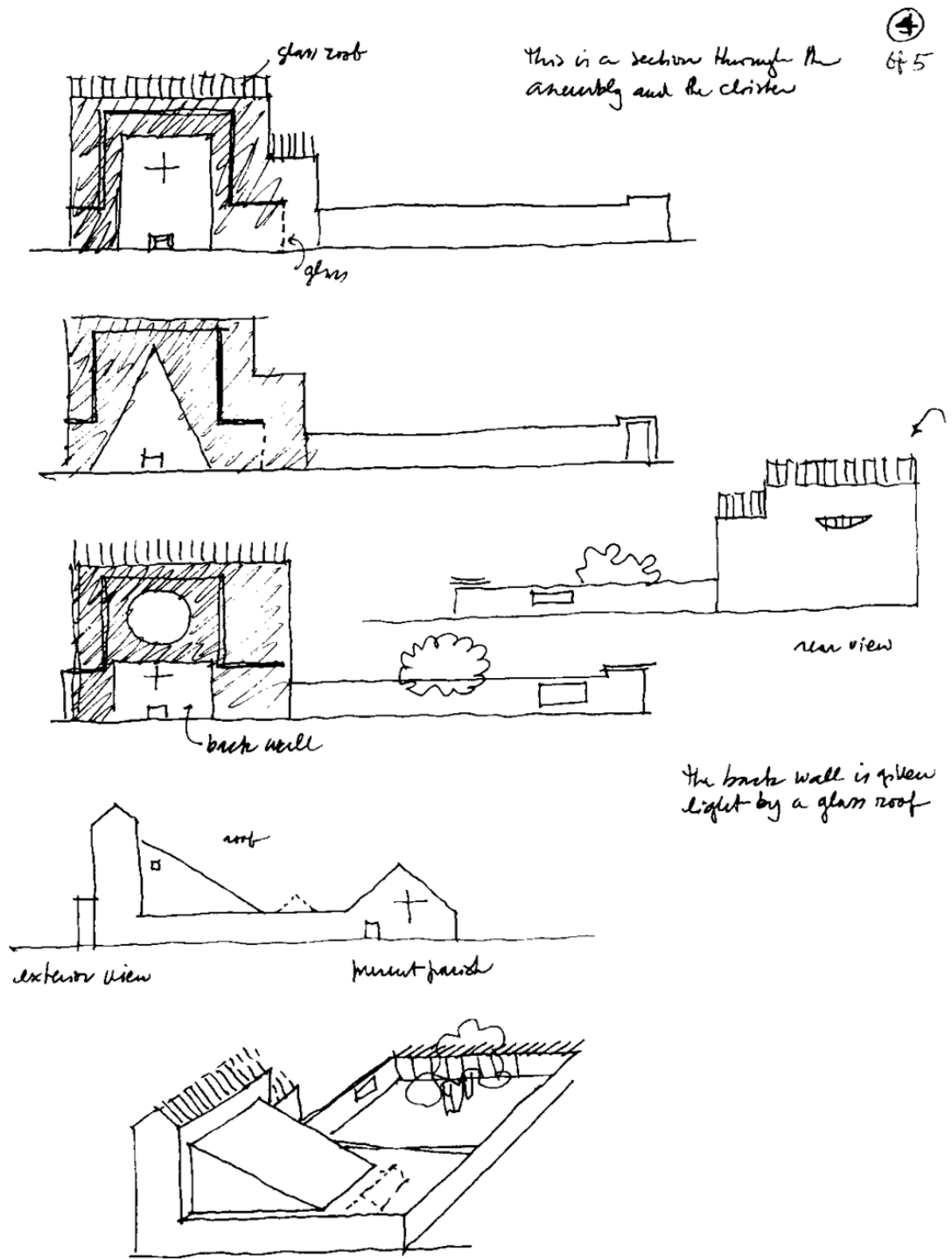

Figure 5.15: Romaldo Giurgola, Page 4 of 5, Facsimile to Pamille Berg dated 25/7/1986. Reprinted with permission from Pamille Berg and Romaldo Giurgola

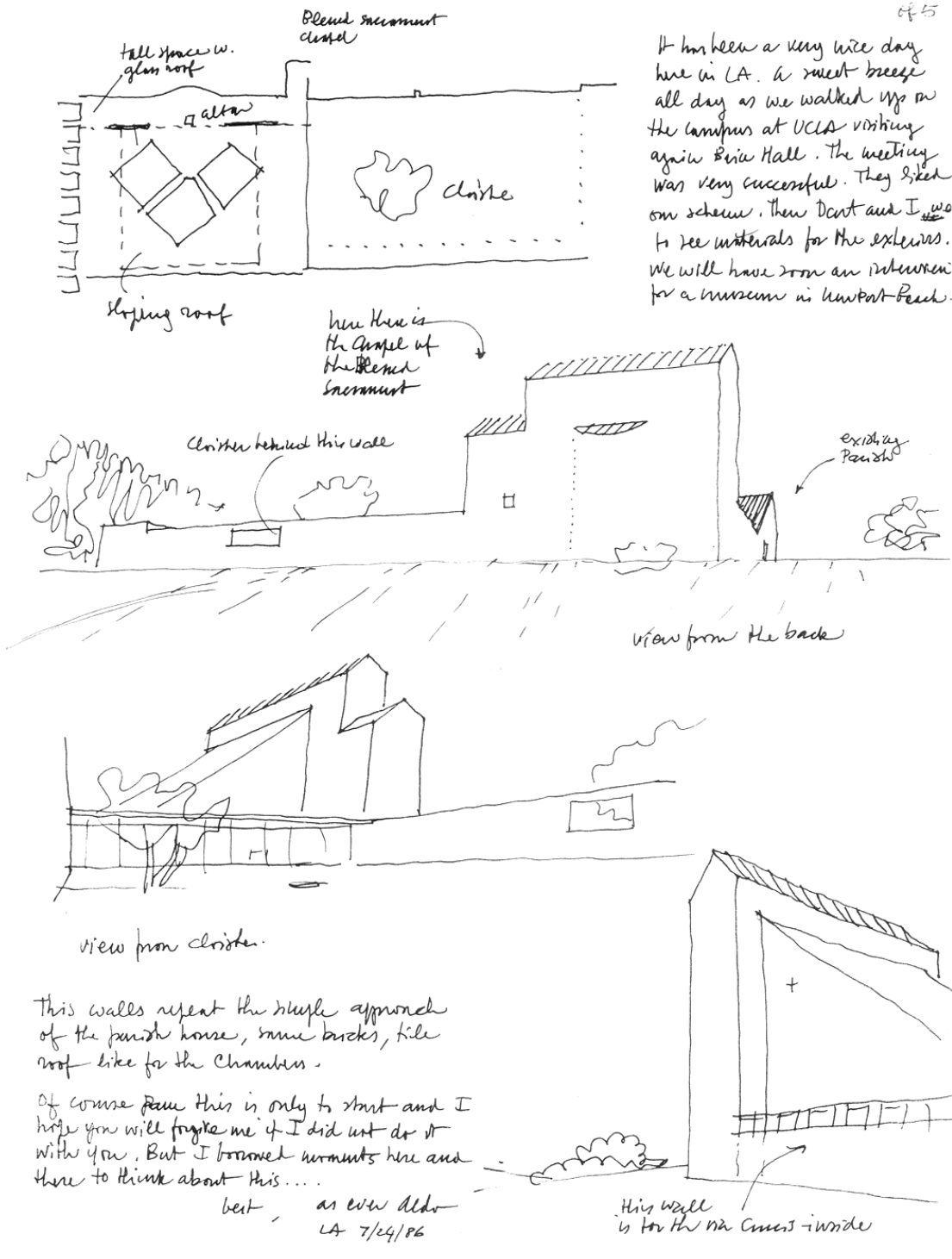

Figure 5.16: Romaldo Giurgola, Page 5 of 5, Facsimile to Pamille Berg dated 25/7/1986. Reprinted with permission from Pamille Berg and Romaldo Giurgola

Analysis

The iconic view of St Thomas Aquinas church is across a gently rising grassy plain on approach to the suburb of Charnwood (see Figure 5.14). Giurgola's church transforms the site. It is not simply that Giurgola composed the building to directly contradict familiar concepts in western architecture, or indeed modern church architecture, but rather that he fused his initial concepts with the site, responding to what Baker terms its *site forces*. The site factors, amongst others, inspired Giurgola's design.



Figure 5.17: View of St Thomas Aquinas looking North. Photograph by John Gollings. © Guida Moseley Brown Architects.

Giurgola sited the building to the south of the existing presbytery and school, arranging the components identified in his conceptual sketches in a geometric layout. The church appears to be laid out in a traditional axial plan and sequence of spaces: narthex–nave–sanctuary, a narrative also employed by Utzon in the Bagsværd church, which was interleaved with open courtyards. A comparison of the plan arrangement with the San Ambrogio cathedral, to which Westbrook refers, reveals a strong resonance with position and orientation of the spaces. However the underlying axial relationship of the cloister differs in each case. San Ambrogio and the Bagsværd church are arrangements of a series of discrete, spatially disconnected spaces arranged in axial alignment. Conversely, Giurgola's St Thomas church has a cross-axial, L-shaped relationship that embraces the cloister/courtyard space. (See Figures 4.15–5.18)

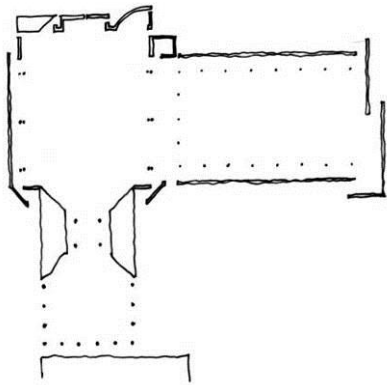

Figure 5.18: St Thomas Aquinas Plan

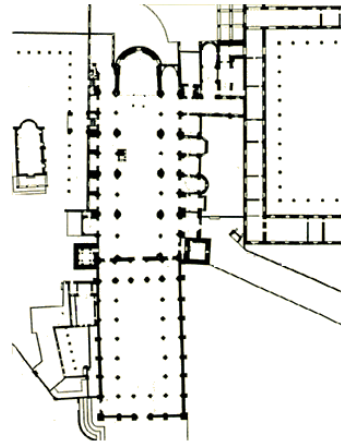

Figure 5.19: San Ambrogio, Milan

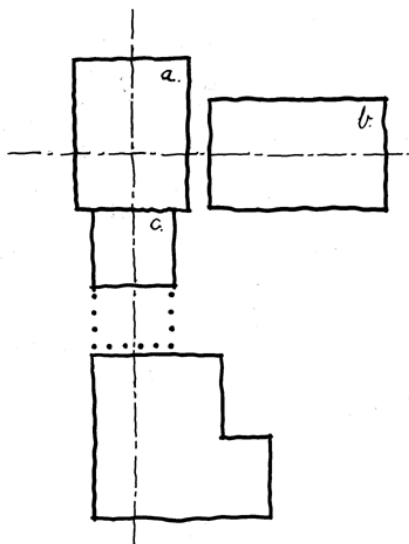

Figure 5.20: St Thomas Aquinas axes arrangement

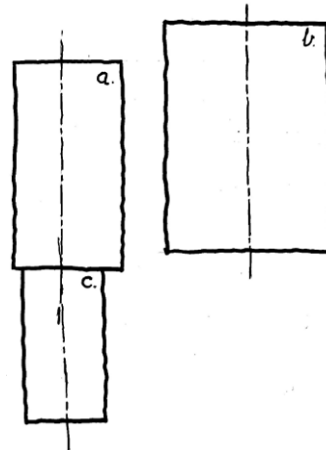

Figure 5.21: St Ambrogio axes arrangement

Again comparing it with the transept example, the generic cross-axial plan suggests a symmetrical distribution about the central nave mass. Instead, the St Thomas church plan exhibits an asymmetry and those absent wings correspond to two of the major site forces, the city to the east and Charnwood suburbia to the North. When considering the distribution of the church volumes, the Griffins' radial plan is an important factor. The church components are influenced by the force exerted by the radial plan for Canberra: the distant counter-point of Black Mountain, the topography of the land, the existing presbytery and the arterial road approach. The Griffins' carefully planned relationship with the natural landforms, Mt Ainslie, Black Mountain and Red Hill, are a constant positioning device when moving through Canberra.

Additionally, the central node of Capital Hill is written into its orientation. Those distant forces aid in understanding the alignment of the building. Pulling the centre of gravity of the building to the south, they are reflected in form as the central mass rises in height. Further, the pull of force is felt where a portion of the main mass is fractured away from the main volume, symbolically indicating its importance.

The result of these forces is an emphasis given to the south-eastern corner of the complex. The central mass is given scale and importance in a 'head and tail' configuration often associated with Aalto. From the east façade, the cloister acts as the tail. The vertical thrust of the dominant mass accentuated by the long, low horizontal wall of the cloister, connected to the horizon and the earth. For the south elevation, the main volume and sacred spaces are given importance by the relationship to the aisle, narthex and ultimately the presbytery.

Conversely, on approach along Lhotsky Street, the effect of the falling height leads the eye to its lower end as the point of entry, expressed as the open area between the narthex and presbytery. The entry to the building is low and small scale, again recalling similar treatment of form and materials of the Bagsværd Church. (See Figures 5.21–5.24)

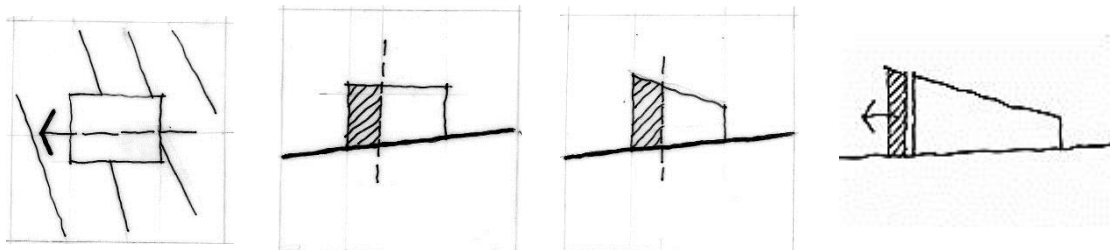

Figure 5.22: Site forces expressed in the form of the St Thomas church

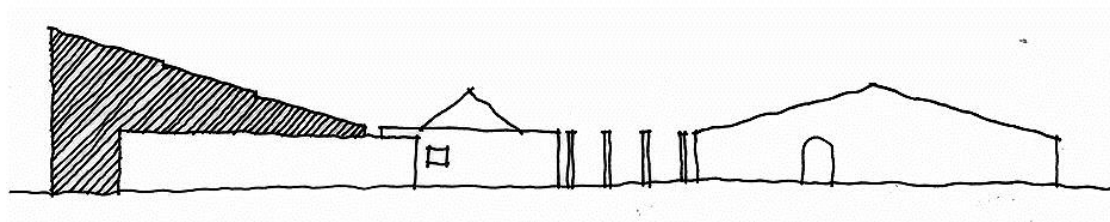

Figure 5.23: South elevation showing the head-tail relationship

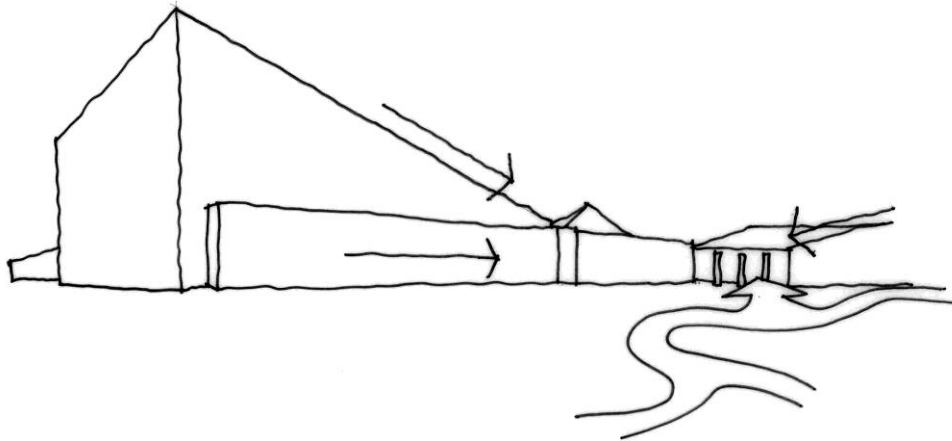

Figure 5.24: Entry expressed by opposing forms and colonnade



Figure 5.25: St Thomas Aquinas entry courtyard.
 Photograph by Loui Seselja, ©National Library of Australia.



Figure 5.26: Bagsværd church courtyard.
 Photograph by Ximo Michavila

Interior

One of the more striking aspects of the interior of the nave is the direct relationship between the interior use and its exterior manifestation, quite unlike Utzon's church, and Aalto's well-known church at Imatra which has a staggering contradiction between the inside and outside skins. The apparent extreme thinness of the St Thomas main volume walls is achieved by a suspension of surfaces, whose support, although carried out by exposed steel portal frames, and is hidden. Slices through the surface, such as the large Christian cross at the end of the sanctuary, also aid to exaggerate the lean enclosure, and the use of oblique natural light further expresses the sheerness of its surface.

Giurgola (2002) commented that the screen typology is a device that he took time to develop:

At one time in the past, the corner was very important. It was a basic element of the structure. All of a sudden, the corner didn't have any value as a structure because the concrete was distributing the load to every column in the same way. So, I started to work on that.

Giurgola uses naturally finished wood consistently in the two public spaces, the narthex and nave, as the material for the ceiling surface. The darkness of the material draws the focus to the more brightly lit end wall. From the narthex, a destination is created by the brightly lit end wall but the low head of its ceiling is not entirely revealed until entering the nave where its ceiling rakes upward as the floor inappreciably slopes to the sanctuary end, recalling Le Corbusier's chapel at Ronchamp. The processional axis is accentuated by the symmetry of the plan and structure, the focus of the cross and the hanging light fixtures, shown in Figure 5.27.



Figure 5.27: St Thomas Interior. Photograph by John Gollings © Guida Moseley Brown Architects

Natural light floods into the main volume from the sides as well as from above, where the sanctuary is fractured away from the volume, and from clerestory windows above. However, the character of the light is controlled, only entering through narrow slots and oblique to the surface it illuminates. The effect as it washes over the surface in this precise way highlights the qualities and slight imperfections of the materials, recalling Alvar Aalto's Church at Imatra and Erik Bryggman's Resurrection Chapel in Turku. The most pronounced religious symbol of the interior is the Latin cross cut into the end wall, which by contrast to Giurgola's description of the effect of light on objects he wishes to produce, is present by absence. Giurgola (1986) describes his purpose in his letter to Berg, 'The focuses [sic] are made clear by light...are the light in a literal sense...It should be real because of the things it touches, giving life to each of them. Walls, floors, tables, plants...' Although Giurgola's architecture prior to the St Thomas Church displays a concern with natural light, this was the first time in his writing that he directly addressed the topic and the effect he wanted to create. Giurgola's appears to want to emphasise the materiality of the object, almost to say that the spirit of the creator lies in contemplation of the object, and not in the transcendental.

In the treatment of the interior, another close resemblance is with Tadao Ando's Church of Light. Completed in 1989 (around the same time as the St Thomas Church), the Church of the Light was a renovation to an existing Christian compound. Like St Thomas, the interior of Ando's Church of Light is minimally adorned, emphasising the inflections of bare materials and the precise and ever-changing washes of light and shadow across their surfaces. The Christian cross cut through its end wall is the only prominent religious symbol present. There are also similarities in the descriptions of the effect wanted by Giurgola and Ando. Ando wrote:

It is necessary to return to the point where the interplay of light and dark reveals forms, and in this way to bring richness back into architectural space. Tadao Ando 1990

The other similar aspect of Ando's church is found in the relationship with adjacent open space, a pattern in Ando's churches and houses. The main space of the wedding chapel on Mount Rokko (1984) is a simple concrete box that opens on one side to a

bounded exterior space. At the Church on the Water (1988), nature, in the form of a pond and a controlled view to woodlands beyond, is the focus. In Giurgola's St Thomas church, the main space is connected through an opening in its side wall to a bounded cloister.

Tadao Ando was a popular architectural figure in the 1980s and first half of the 1990s, consistently producing minimalist concrete architecture that was noted for the creative use of natural light, often in sharp contrast of dark and light spaces³⁴. His Chapel on Mount Rokko and Church on the Water were completed prior to Giurgola's St Thomas and were widely published. Although St Thomas appears to at least reference Ando's later Church of Light in the cross motif, the Ando building was not as widely published until after its completion. Drawings may have been viewed by Giurgola but it is unclear if Ando's building had any direct influence as Giurgola's early sketches of the St Thomas church do not include the incised cross. It may therefore have been a coincident invention, but more significantly, for Giurgola, it signals greater focus on the interplay of surface and light, a key feature of Tadao Ando's architecture.

³⁴ Tadao Ando began to attract the attention of architectural commentators in the first half of the 1980s. A monograph on his work was published in 1984 by Rizzoli, edited by Kenneth Frampton. In 1986 a major exhibition of Ando's work was held at 9H Gallery, London, co-ordinated by Richard Weston. He was awarded the Alvar Aalto medal in 1985.



Figure 5.28 Erik Bryggman's Resurrection Chapel (1938—1941) Turku



Figure 5.29 Tadao Ando's Chapel of Light, (1989). Photograph by Stephen Thomas. CC BY-ND 2.0



Figure 5.30 Tadao Ando's Chapel on Mount Rokko. Photograph by Raphael Franca. Used by permission.

Artists and artisans

Elements of the church's interior Giurgola were turned over to artists and craftspeople, as for Parliament House. The altar, baptismal font, sacral furniture, pews and rough-hewn logs that enclose the forecourt were crafted in collaboration with Kevin Perkins, a Tasmanian timber craftsman who had done work for the Prime Minister's office in Parliament House. Giurgola (2002e) also attributed to him the forecourt configuration of the twelve posts.

The other item created by an artist is a ceramic tile artwork applied to the pedestal carrying the sacred vessels in the Blessed Sacrament Chapel. The use of artists has intensified in the latter part of Giurgola's career and can be attributed to his Swedish

experience, particularly his association with Lin Utzon, as discussed in the preceding chapter.

In describing his work at the Australian parliament building he states:

And with the artwork, I was hoping to touch the base. I was convinced that architecture can be an artwork but architecture is not only that. It involves making places for living without forcing anything on anyone. I asked for the painter, the craftsman to make this connection. When Gehry does a building, you can hardly do anything else but an abstract artistic experience. (Giurgola, 2002d)

Ruination/incompletion

Where the St Thomas Church departs from familiar concepts is not obvious on first inspection. On closer examination however a number of elements do not fit with common expectations. The first of these is the arrangement of the cloister adjacent to the main worship space. Giurgola's image of the cloister is one of contemplation as expressed in his letter to Pam Berg. And yet, the north and south walls of the cloister are fragmented. To the north, the enclosure seemingly given by the wall of the main worship space opens into the nave, connecting the two spaces. This was a theme explored earlier in the Lang Music Building at Swarthmore College (1970–1974) in which the main performance space opens onto the surrounding woodland. Aalto's influence can also be seen here in the design of the housing for the organ. (See Figure 5.32)



Figure 5.31: Lang Music Hall Building at Swarthmore College, Delaware County. Photograph by Rollin La France. © The Architectural Archives of the University of Pennsylvania.

To the south the cloister wall is broken into fragments and the pergola over is omitted. The ‘gaps’ formed by the ruined walls allow the surrounding bushland to be viewed from the contemplative space. Further, there is a spattering of apparently unarranged bushland that invades, slinking in through the gaps, adding to the confusion as to whether it is a space for internalised meditation, purged of nature, or one for outward observing and which embraces the changes of seasons and untidiness of the Australian bush (see Figure 5.33). The loose definition of the courtyard is an expression reminiscent of similar constructed courtyard ruins of Aalto at both the Säynätsalo Town Hall and his summer house wherein a connection with nature, distant and close views is carefully considered. On the other hand, the courtyards of Utzon’s church are controlled and unified. (See Figure 5.35)

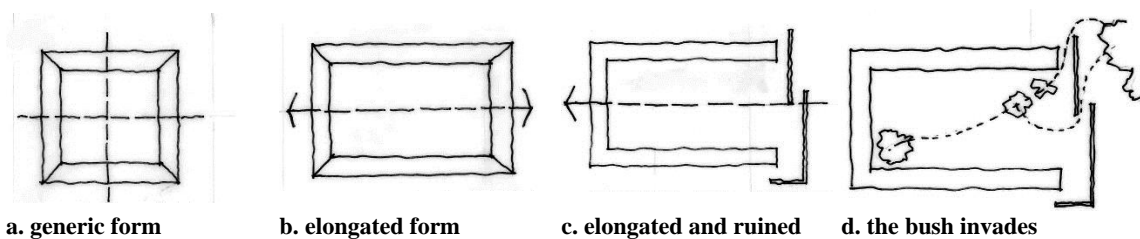

Figure 5.32: Progression from generic to ruined forms evident in the St Thomas courtyard.

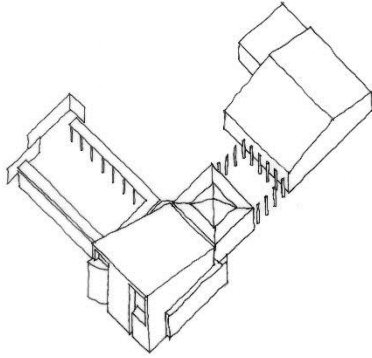

Figure 5.33: Axonometric of St Thomas, showing the loose definition of its courtyards



Figure 5.34: Courtyard of the Bagsværd Church—controlled and organised. Photograph by Addison Godel

Similarly, there is a carefully constructed use of materials for the exterior of the building. Giurgola breaks the building into elements that correspond to the surrounding context. Constructed of a rough-faced brick, the aisle materials resonate the existing presbytery and the character of suburban houses in nearby streets. Behind the aisle stands the enclosing wall of the main volume containing the nave, made in a smooth-faced brick and painted white. Symbolically, the nave strikes a clean figure against the sky, the heavens; and the aisle is tied to the earth and the human suburban dimension. Meanwhile, the narthex roof is a reiteration of the larger pyramidal form of the neighbouring school and the hipped roof forms of Charnwood suburban housing (see Figure 5.35 and 5.36).



Figure 5.35: View of St Thomas showing the presbytery in context. Photograph by author

The contextual motif occurs again in the choice of roof materials. The terracotta roof repeats the qualities of the presbytery and, equally, the roof forms of the commercial district and suburban houses. Giurgola is very particular about this point in his letter. He states on the fifth page, ‘This [sic] walls repeat the simple approach of the parish house, same bricks, tile roof like for the Chambers’ (Giurgola, 1986). The chambers Giurgola refers to are the two houses of Parliament House.

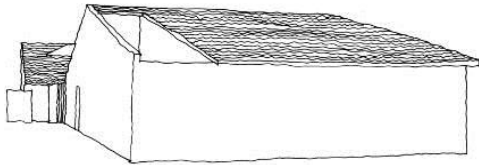

Figure 5.36: Agreement of the roof of the nave and the roof of the pre-existing presbytery

An element of the east façade composition is, however, the most pronounced and intriguing instance of Giurgola’s reference to context. Shown in Figure 5.38, the modelled end façade is composed of three forms in which the centre piece of the arrangement, the apse, is a large cross sliced through the surface, rather like a sign-board. At either side are two lesser forms, one curving, and poetic, containing the confessional, and the other small and oddly domestic in scale, containing a small anteroom. This combination of elements creates an intrigue in the composition, particularly so in the case of the small domestic-scale element, which resonates a ‘lean-to’ outbuilding or ‘add-on’. The clerestory window over the altar is the less visible repeat of a comparable use of familiar suburban forms. The effect is a visual anxiety, as in Griffiths’s diagram of the palazzo; a tension that increases the appearance of a monumental scale in the other elements of the composition.



Figure 5.37: East Elevation, St Thomas Aquinas

This study has provided an example of how Giurgola has developed a formal solution around familiar concepts in Western architecture, but through the employment of a range of intrusions, has sought to rework the historical representation of the divine presence. There are obvious references in the form and materiality of the St Thomas Church to the work of Alvar Aalto's Villa Carré, but it is the underlying device of incompleteness that challenges the historical formula of a centred spatial *stasis*, while and at the same time the odd intrusions aid to fuse the architecture to its place, a quality that is much admired and recognised in the work of Aalto.

Formally and symbolically, the St Thomas church in its context can be understood as a conversation along two axes. The major axis is the procession or transition from the secular to the sacred re-affirming the traditional processional rites of the church. Meanwhile, its cross axis, south-west to north-east, is the axis of incompleteness/ruination. Bell (1979) sees ruined elements such as the courtyard as picturesque incompleteness that challenge the concept of unity in Western architecture. But Giurgola's composition goes further than questions of unity to contest core polarities of historical forms vs. the modernist idiom of a clear expression of function alone. Figure 5.38 shows how in one direction, the sacred space converses with nature through the cloister, and in the cross-axial direction, the use of materials and elements drawn from suburbia are in dialogue with the context onto which the church faces.

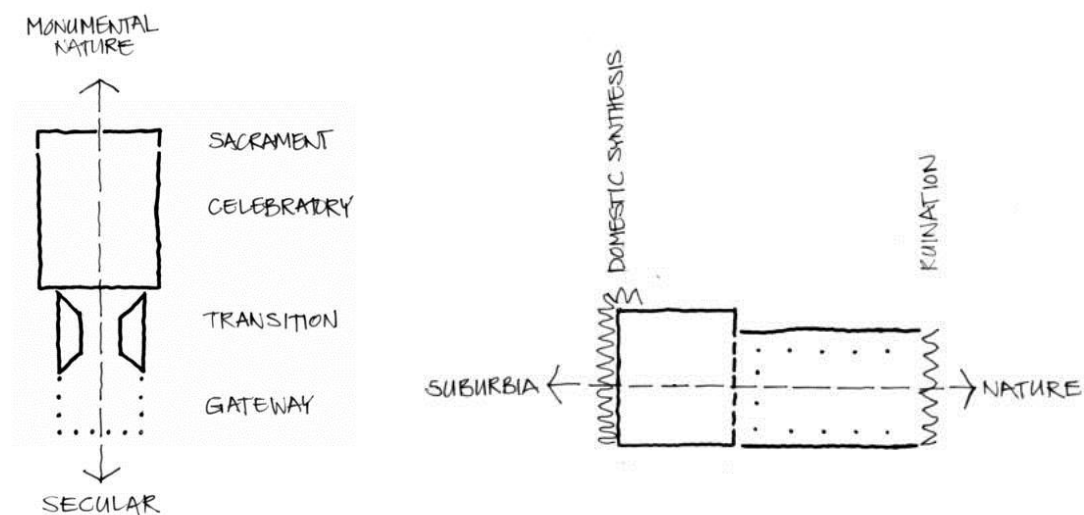

Figure 5.38: The two axes of St Thomas

Giurgola's church is less dynamic than Burgess's Church of St Michael and St John, and less overt in its embrace of suburban motifs than Edmond and Corrigan's Chapel of St Joseph, but the inclusion of ordinary elements drawn from suburbia is done in a way that is a critique of mainstream modernism, but also contrasts with the whimsical side of the post-modern. Giurgola used the ordinary to create a conversation between the building and its context, suggesting that perhaps Australia is not formed entirely of lower middle class aspirations. This is distinct from Venturi (1966) who explicitly rejected idealism, stating '...I accept what seem to me to be architecture's inherent limitations, and attempt to concentrate on the difficult particulars within it rather than the easier abstractions about it...' and Corrigan, after Venturi, who, according to Evans (2005), viewed suburbia as a place unrestricted by 'approbation of middle class intellectual guardians of public taste'.

At the same time, the small scale elements drawn from suburbia act to amplify the modestly sized church. Giurgola had experimented with the effects of changes of scale in the earlier Condon Hall, and Parliament House to mediate between the outside and inside, and between the scale of the Canberra landscape and the scale of Parliament House. In my conversation with Giurgola he empathised with the parish priest for his 'poor' accommodation (Giurgola 2002). The incorporation of the existing presbytery as an integral part of the design demonstrates Giurgola's concern with lifting the quality of the whole by careful consideration of its individual parts, or fragments. The presbytery's giant cross has affinities with the types of signs that Venturi may have promoted. Giurgola, on the other hand, subtly integrates historical 'signs' into the building narrative, but sets them ever so slightly on edge so as to challenge their familiarity. Giurgola saw the role of the church as being the mediator between aspiration and the middle class, architecturally, and more broadly.

Chapter 6 St Patrick's Cathedral, Parramatta (1997–2003)



Figure 6.1 St Patricks Cathedral. Photograph by author.

Introduction

On February 19, 1996, the St. Patrick's Cathedral, Parramatta, was torched by an arsonist and destroyed by fire, with only its tower and nave side walls remaining. Its destruction, however, opened an opportunity for its remaking to better house a Diocese for which the pre-existing church was a squeeze³⁵ and one that reflected contemporary Catholic liturgy. Although reconstruction of the original building to its pre-existing form appealed to the symbolic healing of wounds, the decision was to construct a new space, restoring the burnt church as a linked chapel. A new cathedral

³⁵ In 1986, the Catholic Diocese of Parramatta was established and St Patrick's Church, constructed in 1936, was designated a Cathedral

was a rare undertaking in the late 21st Century, and was to be the fourth iteration of a major church (but the second cathedral) on the site, including an Augustus Welby Pugin design partly demolished and re-configured in 1936. Giurgola was drawn out of his official retirement by the prospect of such an uncommon event. It was a project to which he dedicated a number of years of his late career, completed when he was 82 years of age, and his final design for a larger scale building.

The entire program included restoration of the church ruin, a new worship space to seat 800, a church hall, car parking and refurbishment of open spaces around new buildings and other structures to be retained. Giurgola's design placed the cathedral space at right angles to the existing church which was reconfigured to act as part entry and a small chapel for smaller services. The seating in the cathedral space is arranged 'in-the-round', sloping up either side of a sunken well containing the altar – a great slab of black stone – at its centre, the president's chair and lectern. Giurgola described the arrangement as akin to dry river bed. Adjoining the cathedral is a grassed cloister bounded on all sides by a rhythmical colonnade, and across the open space is the church hall.

At first glance, with its reflective pre-cast screen walls and flush windows, St Patricks Cathedral appears an orchestrated contrast to the deep set windows and moulded solid exteriors of the site's earlier buildings, a quite a different approach to the preceding St Thomas Church. St Patricks. Where the St Thomas Church is a harmonious variation on the suburban theme, the sparsely ornamented St Patricks is the more subtle, refined building. And yet, like St Thomas, there appears empathy between the new buildings, the restored pre-existing church, and their greater surrounds. In addition to narrating the history of its making, discussion and analysis presented in this chapter looks to understand how Giurgola achieves this responsive conversation between the various site forces and influences. By comparison to Giurgola's previous work, and the work of other relevant architects, it seeks to draw out patterns that bring together what might seem like dissimilar tactics into a consistently applied strategy. The study is informed by original documents sourced from the Mitchell/Giurgola and Thorp Architects archives, interviews with Giurgola, design team members, and client representatives.

I worked in the design team on this building from 2000 until 2003, in its detailed design and documentation.

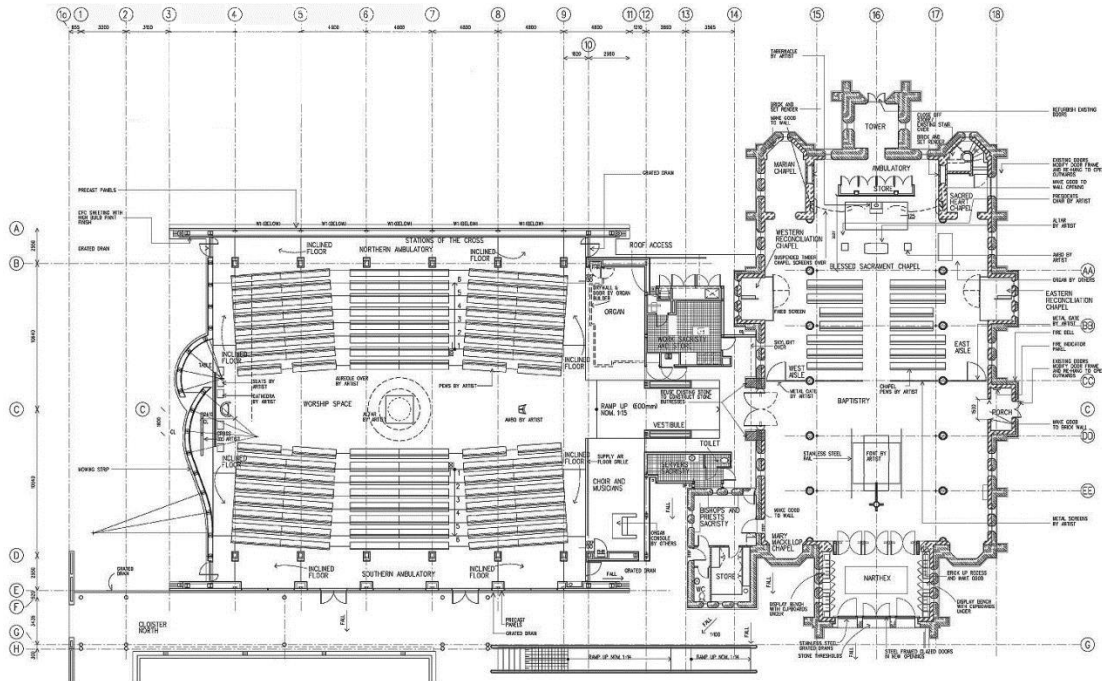

Figure 6.2 St Patricks Floor Plan. Guida Moseley Brown Architects.

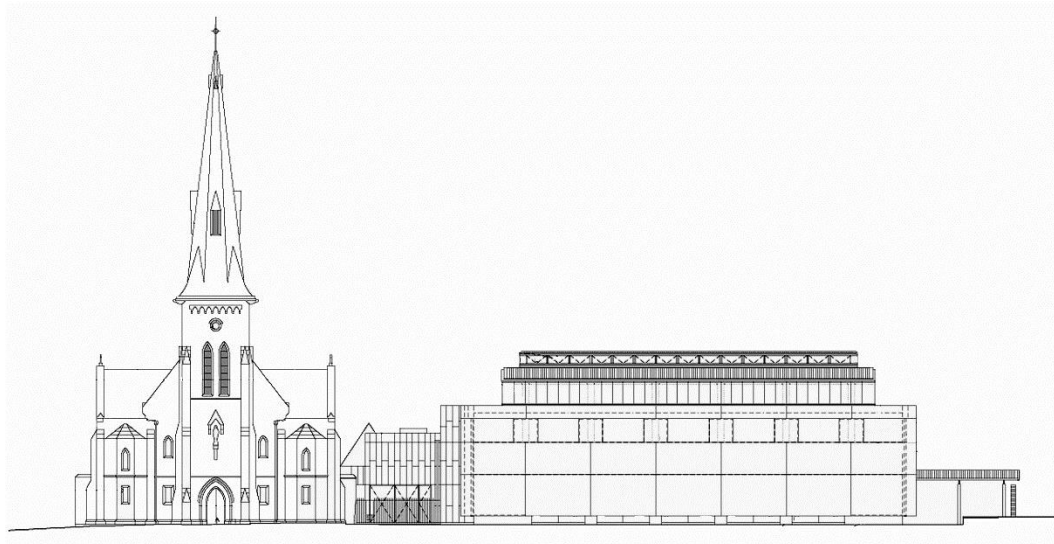

Figure 6.3 North (Victoria Road) Elevation. Guida Moseley Brown Architects.



Figure 6.4 Section through Chapel showing the relationship to Murphy House. Guida Moseley Brown Architects.

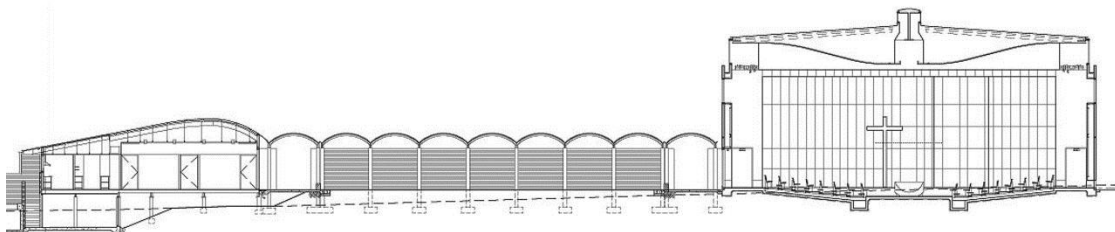

Figure 6.5 Cross-section through the cathedral nave, cloister and church hall. Guida Moseley Brown Architects.

‘Genius’ architect³⁶

The destruction of the Cathedral evoked extraordinary feeling in the community. The Premier, Prime Minister and Governor-General all visited the site to inspect the ruins. The Bishop of Parramatta at the time, Most Rev Bede Heather, promised parishioners ‘A new St Patrick’s will rise from these ashes’. A later announcement by the second Bishop of Parramatta, Most Rev Kevin Manning, asserted that St Patrick’s Cathedral would be restored to regain its place as a building of historical significance in the local landscape.

³⁶ A term used by Bishop Manning to describe Giurgola’s contribution to the project.

Although little is known about the motives of the arsonist, Father Boyle, Dean of the Diocese at the time of the fire who witnessed the church's destruction, recalls that the then Bishop, Bede Heather, directed him to visit the arsonist in the cells under the Parramatta Courthouse. He notes,

This caused something of a storm at the time among parishioners and some of our community leaders, with newspaper headlines and interviews and talkback radio in which people declared outrage that the perpetrator should be forgiven for destroying such an historic building and worship space that was so important to them (Davies, 2007).

The first Catholic church on the site, completed in 1837, was demolished less than 20 years later as it began to display structural problems. The second St Patrick's was completed in 1859 to an Augustus Welby Pugin design. By the 1930s, this St Patrick's was not adequate for the congregation, and a third church was completed in 1935, but retained the tower of the original Pugin-inspired design and much of its stone detailing by recycling the stone work into a building with greater girth. The development of the site also included various church buildings accommodating related uses. By 1997 when Giurgola came to design the new cathedral, the site contained an array of buildings in a range of architectural styles.

A member of the Diocese rebuilding committee, Father Williams reports that the church executive sought expressions of interest from several architectural offices but notes that the procurement process was prior to his arrival at St Patricks. Additionally, he mentions that Father Drinkwater of St Thomas Aquinas recommended that Aldo's advice be sought. Documentary evidence to support Father Williams' account was not available. However, we do know that MGT Architects were commissioned for the Cathedral design in 1997.

The Cathedral project was first in the Sydney office with the master planning stage done by Aldo with assistance from partner Richard Thorp (H. Guida, 2014). Later stages moved to the Canberra office which reflected Giurgola's age and consequent reluctance to travel. Aware of the limitations presented by Giurgola's advanced years, Pam Berg made efforts to arrange a comfortable working environment for Giurgola

(Berg and Williams, 2011). Berg set up a discrete team in the office consisting of herself, Robert Thorne, and MGT administrative partner Tim Halden-Brown, all of whom had worked on Parliament House and the St Thomas Church. Berg states that Robert Thorne's role in the project should not be understated (Berg, 2007).

Berg also had considerable influence over the structure of the client group. Encouraged by Parliament House experience, Giurgola and Berg supposed that stable client representation was necessary for the trouble-free delivery of a major building. This, they believed, could be applied to St Patricks and they sought to influence the selection of the client steering group (F. P. Williams, 2010).

After their appointment the design team from MGT Architects undertook a 'Grand Tour' of Catholic churches of Sydney (Williams 2010) in order to contemplate the building of a 'modern cathedral' – in the architectural sense – in the context of a modern liturgy. A church noted as particular reference in later meetings was the recently completed 'Our Lady of Fatima' in Caringbah by Allen Jack + Cottier Architects (1999). Giurgola's St Thomas church also featured in discussions. It is perhaps not surprising that the Caringbah church was a topic of conversation considering its choir plan interpretation of the liturgical principles set out by the Second Vatican Council. Its designer, Keith Cottier, had affinities with Scandinavian modernism.³⁷ Our Lady of Fatima and St Patricks are remarkably similar in the choice of internal materials and finishes, the Cottier building recalling the timber structures of Aalto's Säynätsalo Town Hall (See figure 6.6).

³⁷ In 1962 Cottier, freshly graduated from Sydney University, travelled extensively through Denmark, Norway, Sweden and Finland. Architects or buildings left a deep impression on him were the work of Erik Gunnar Asplund, Alvar Aalto, Kaija and Heikki Sirén's Chapel and the newly completed Cremation Chapel at Gävle (1960) by Alf Engström, Gunnar Landberg, Bengt Larsson and Alvar Törneman. (Trevor Howells, Architecture Australia 2001). Glenn Murcutt, a long time friend of Cottier's, once commented that it was Cottier who convinced him to visit Finland and study the work of Alvar Aalto. For a fuller discussion on the influence of Alvar Aalto in Australia, see (Radford & Schrapel, 2014)

The issues presented by an inclusive worship ideology were not the only test for the design group. The brief for St Patricks also demanded a use for the ruined structure that, if repaired, was not adequate to current demands as the principal worship space. Thus the three central challenges were: a use had to be found for the ruins of the old Cathedral; the accommodation of a modern liturgy; and the location of a large building within an already crowded site.

The Cathedral was dedicated on 29 November 2003.

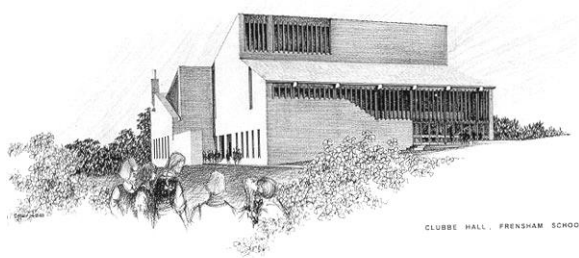

Figure 6.6: Cottier's Frensham School, 1965, that has resemblance to Alvar Aalto's architecture

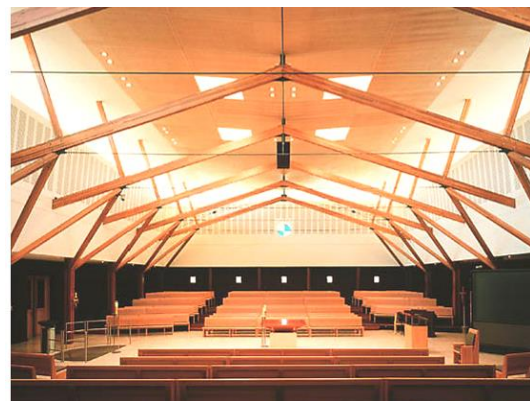

Figure 6.7: 'Our Lady of Fatima', Caringbah, 1999. Photograph by Liz Cotter.

'St Bunnings'³⁸

Reviews of the building that appeared in Australian journals were brief and generally approving. Curiously, all reviewers refrain from comparisons with Giurgola's previous work, or the 'post-modernist tradition' that framed so much of the criticism of Parliament House. Instead critics wrote on the particularity of the building, and the unusual aspect of constructing a cathedral early in the 21st century.

³⁸ A reference to an Australian hardware retailer, well-known for its large and anonymous warehouse outlets across Australia built to a standard design.

During the construction of the cathedral Elizabeth Farrelly reviewed the plans for the *Sydney Morning Herald*. She places the projected new cathedral in the context of its Pugin background and the history of the three previous churches on the site. Farrelly finds that the plans for the new cathedral hold a promise of a building that is ‘intelligent, elegant, coherent and possibly beautiful, bringing graciousness and order where there was abrupt disjunction’ (Farrelly, 2002). Her ‘rub’, though, is a wider held view about the obliteration of the ‘mysterious Other’ via the communal worship interpretation of the Vatican II Council and the loss of darkened spaces as a result of modernism’s obsession with light filled boxes. Farrelly’s ‘tentative fear regret’ laments the ‘devotion to light over darkness and ‘now’ over ‘then’ in the loss of shapes and shadows and lofty ceilings of ‘Pointed Architecture’. Farrelly fears that Giurgola’s ‘flattish ceiling (with spinal Louis Kahn lantern) and sheer number of lux’ will be taking the ‘god out of gothic’. Of the refurbished chapel (former cathedral space) she has reservations that the now ‘smooth white ghost of its cremated self, will gather swathes of relative gloom’. Farrelly suggests a lantern over the cross axis of the two spaces may have better served the nexus between the two.

Later on, when discussing the paradigm shift in church buildings in Australia towards ‘Abandoning the mystery, axiality and otherness of the traditional Eucharistic church’, Farrelly is more pointed stating that the Parramatta Cathedral has a ‘dog leg axis, central altar, flattish ceiling and horizontal aspect to give the mystery-levels of a standard school gym’ (2004). Farrelly’s view is that churches particularly should house ‘beauty and distance’ in their designs.

Architecture Review Australia put the sculptural end wall of the cathedral on the cover of its 91st edition, entitled ‘Memory and Invention’. The edition features the St Patricks Cathedral alongside ten other adaptations and/or additions to historic places. In his opening to the selection of projects that follow, editor Andrew Mackenzie’s comments (2004) on the ironies of heritage protection over Paris, a city largely rebuilt in the 1850s. He summarises the examples as ‘a range of projects actively engaged in the communication between memory of existing built form and the spirit of contemporary invention’. Amongst others, it featured The Shrine of Remembrance by Melbourne architects, Ashton Raggatt McDougall and the transformation of the

Mint Coining Factory into the headquarters of the New South Wales Historic Houses Trust by Giurgola's protégés, Francis Jones Morehan and Thorp.

In the one page review of the cathedral by Jennifer Taylor (2004) (the text appeared in the shape of a cross), Taylor commends Giurgola's 'masterly resolution of old and new', recognising the paradoxical coherency that Giurgola achieves between the two. She writes,

It is however, in the resolution of the past and the present-day in the cathedral building that the design excels. There is complementary affiliation of the dissimilar; it is, in turn, enriched by the contrast and seems to glow with calmness and peace...The rapport between opposites is masterly...

Taylor goes on to praise the cathedral's works of art as well as the 'emotive accord' of the intimate smaller chapel interiors and 'simple grandeur' of the cathedral nave.

Naomi Stead (2004) is more circumspect in her review published in *Monument Magazine*, agreeing with some of Farrelly's earlier comments. A good deal of Stead's article reflects on the larger questions associated with the construction of a new cathedral, '...strangely – and fascinatingly – out of time...: the changes in liturgy of the Second Vatican Council and that there is no longer an established style or language for church architecture'.

Stead's praise in the article is directed to the works of art and the way in which they are couched, stating that, 'The art program is crucial to the overall effect of the new cathedral' (Stead 2004). However Stead has a reservation with the connection between the main space and its adjacent cloister. She considers that the opening of the south wall to the cloister and the 'banal' parish hall beyond is unbecoming to a cathedral. She writes,

Though the idea is good – Giurgola speaks of opening the church up to life in the world, of children playing in the open space... - in practice the proximity is distracting...Likewise the cloister, while it has a cheerful kind of Australian vernacular, it seems to lack the

gravitas required for a space directly visible from the interior of a cathedral.

Like Farrelly, Stead admits that her view may be the aesthetic judgement of a non-believer and suggests that perhaps it is out of turn for her to examine the fittings and architecture of a cathedral on this level. Notwithstanding her censure of the cloister, Stead concludes that, 'It is surely one of the few, and one of the finest, religious buildings to be constructed so far this century'.

A very short review in the journal *UME* also framed the cathedral in the context of liturgical revisions and their impact on church architecture, claiming that the collision of liturgical shifts and modern architecture has, in this case, resulted in a 'building typology closer to a modern university great hall – or even a school gymnasium' (Haig Beck & Cooper, 2005). The article goes on to comment that its context is all that distinguishes the cathedral from the University of New South Wales Scientia building. However, the authors note, the articulation of the roof as a separate element to the walls has been given greater emphasis in the cathedral so as to 'reveal an idea of the interior volume as a light-filled box'. In 2004, in awarding the building the Sir Zelman Cowen Award, the jury (2004) remarked that the design for the new cathedral and chapel was, 'masterfully handled in a restrained yet inventive way'.

In 2006 Macmillan published a luxurious volume of 190 pages on the Cathedral titled, *Luminous Simplicity: The Architecture and Art of St. Patrick's Cathedral*. It contains no less than 200 images including high quality photographs, construction drawings and Giurgola's sketches. The book is set out in a chronological journey from 'The making of a church' (Chapter 1) that gives a very brief overview of the site's history and the fire event, to a final chapter named 'People and Spaces' (Chapter 7) that presents photographs of the cathedral's consecration. Narration through the journey is provided by Giurgola and Pam Berg in which they set out the central ideas of the design. There are several key concepts described, including a critique of the client briefing documents, the 'Surrounding Context', daylight management in the cathedral space, 'The itinerary of the completed building from interior to exterior', 'Construction detailing: the transformation of idea into form', and how an art program was integrated into the design process. The forward is provided by Bishop Manning.

The story presented is completely devoid of the angst and disruption that usually follows a complex building project, and is blind in its photographs to the site context of the building outside of its immediately adjacent neighbours.

Broader reaction outside the architectural fraternity was various. At the opening ceremony New South Wales Premier Bob Carr stated that the cathedral is, ‘the best of the modern church buildings we’ve got’ and promised, ‘If this building doesn’t get an architectural award, I’ll create one for it’ (Carr, quoted in (Stevenson, 2003)).

Meanwhile detractors described the design as ‘stark’, ‘ultra-modern’, ‘not a prayerful space’ even as ‘ugly as sin’ (quoted in Stead 2004). This catholic blogger’s account (Schütz, 2010) of his participation in mass at the cathedral is an amusing anecdote:

One good thing that can be said for the new Parramatta Cathedral (aka St Bunnings) is that it has good acoustics, thanks to plenty of hard edges and a high roofline. Aside from that, the set-up of the Cathedral – with pews in rows facing each other ‘choir’ style, the large central granite square altar, bishops cathedra one end under a very modern huge metal crucifix and the lectern at the other end – means that there is effectively no ‘sanctuary’ and people enter at the beginning and mill around afterwards all around the altar. The old Cathedral – used now as a Narthex – houses the Blessed Sacrament Chapel (inside a large ‘easter egg’) and the baptismal font and pool. As one person said: It is an excellent example of ‘that’ kind of layout. All in all it is not what one would call practical. And someone from the other side of the Cathedral said they spent the mass trying to work out what was on my tie (I was seated at the back of the other side facing them).

Even so, Father Peter Williams, the liturgical member of the project reference group, writing later about his experience found that the St Patricks cathedral has the necessary ingredients for the modern requirements of Catholic worship (P. G. Williams, 2009). Williams considers that a successful Catholic ‘place’ should contain the memory of the place; an appropriate space for ‘ritual performance’ and the narration of it; and promote the ‘participated in Mass’ from the Second Vatican

Council. According to Williams, St Patricks succeeds in each of these aspects. Re-building the cathedral on its current site and re-using the building satisfies the memory of past Catholic occupation of the site. Giurgola's narration, from baptism to the crucifix, evokes a past liturgical ritual, but allows for a modern inclusive performance by its choir arrangement of the congregation. Finally, echoing Eliade's 'The Sacred and the Profane' (1959), Williams makes a distinction between early forms of worship that centred around naturally occurring primal forms (mostly rocks and mountains), and the tradition of a container designed to inspire 'awe' stemming from the Roman acceptance of Christianity. Williams offers Massimiliano Fuksas's church in Foligno, Umbria as an example of a contemporary building capable of creating awe by which designed space is the conduit for the Divine Presence.

Some common themes

Although acknowledging it as a confident work of its type, few see St Patricks as confronting the status quo of Australian architectural culture. Its inclusion in *Architectural Review Australia*, for example, positioned St Patricks amongst a range of other recently completed projects associated with historic buildings—in the space between 'Memory', represented by pre-existing historic buildings, and 'Invention', being the contemporary overlay on the place. In the main critical piece, Goddard (2004) comments that as a colonial nation, unlike other 'older' nations, Australians seem to see their historic buildings as 'something "other" than the norm'. The range of 'inventions' presented in the journal gives a snap shot of the responses to this space, and allows for contrasts to be drawn between their methodologies: from the serious, clean glass and screened boxes as in the Francis-Jones Morehan Thorp's Coining Mint conversion to the abstracted contrasting approach taken by Ashton Raggatt McDougall at the Shrine of Remembrance in Melbourne. In his review of the Shrine of Remembrance, Leon Van Shaik characterises the responses to the Australian historic space as being between the polite correctness of a 'Sydney School' whose work is comparable to that of the Yoshio Taniguchi design MOMA expansion (2006) in producing 'bland boxes' and the edginess of a 'Melbourne School' who produce 'instruments of nationhood', epitomised by Ashton Raggatt McDougall's earlier National Museum of Australia. Presumably Francis-Jones Morehan Thorp's Mint, in Van Shaik's view, is relegated to the politely correct category. Although the

Sydney/Melbourne duality is questionable, Van Shaik articulates a persistent theme which other reviewers of the cathedral building have sought to tackle: what is the relationship between the memory of the place symbolized in the pre-existing fabric and an intervention? Taylor's review would seem to put St Patricks in the Sydney camp of buildings that are neo-modern, contextual and much too polite.

The second consistent theme is the expression of rarity of cathedral building in the modern age. Farrelly's reluctance to approve Giurgola's design is rooted in her feeling of a disruption in the order of cathedral building and its liturgy. Similarly Stead's review more simply points to a lack of 'gravitas' in the new cathedral. On the other hand, Williams finds that 'awe' is a necessary feature of the post-modern church to separate sacred space from its environment, and the St Patricks cathedral has it in spades. The emphasis on the remnants of Pugin-inspired cathedral as the image of the Catholic Church in the reviews is perhaps a consequence of its power as a symbol. Beck & Cooper mention the typology of a gymnasium or a university hall. It is left to talk about broader architectural/cultural issues around the relationship between buildings and their consumers. St Bunnings, quipped the blogger.

The mixed responses to Giurgola's cathedral point to a degree of unease in how to place and examine an architect who appears alien to the scene. There is acknowledgement of the quality of the work, but an anxiety present that expresses a paradox whereby an architect who is so clearly linked to a past generation and another place is placed alongside the Sydney avant-garde. It is perhaps easier to imagine him living out his retirement through endearing mediations on the Canberra suburb, such as the Charnwood church, than in the heart of Parramatta. There is also implicitly an admission, by putting Giurgola's architecture alongside work of the next generation that Australian architecture has not thrown off the struggle felt by the previous generation. A more sustained understanding of the range of issues introduced by Giurgola's intervention is not carried out, adding to the appearance of his relegation to the outmoded.

Formal Analysis

The site

The St Patricks cathedral is located on the corner of Victoria Road and Marist Place, Parramatta. Its spire addresses the often-busy Victoria Road which ends close by the cathedral at the gates of the Parramatta Rugby League Stadium. The old cathedral's nave is flanked, opposite on Marist Place, by the formal layout of Prince Edward Park; the back drop of which is the Parramatta Town Centre. Strung along Victoria Road are commercial, strip retail, institutional and multi-unit residential buildings of no cohesive character, varying in age, height, type and materiality. Giurgola describes the context of the Prince Edward Park as, 'surrounded by rather un-descriptive (or over-descriptive) buildings' (Giurgola & Berg, 2006). As well within the site, the unrelated assortment of architectural styles built up since the founding of the church on the site in 1835 repeats the pattern of the greater area.

Politicians have given the area a variety of labels from 'Howard's Battlers'³⁹, to the 'Aspirational Classes'; Western Sydney has been the ground for political jockeying, often seen as the microcosm for greater urban Australia (Arvanitakis, 2013).

Compared to the niceties of the two previous Canberra sites for Parliament House and St Thomas, the realism of Western Sydney was seemingly ready fodder for a Post-modernist critique that one might anticipate from a supposed herald for the movement.

³⁹ A reference to former Australian conservative Prime Minister John Howard who made frequent use of the term.



Figure 6.8: A view up Victoria St towards the cathedral spire (Google Street View 2013)

In a site analysis sketch, Giurgola reduces his consideration of site elements to the natural features of the local area such as the Parramatta River, and important early buildings, the Old Government House and St Johns Anglican Church. Although they appear in Giurgola's sketch associated by routes through Parramatta, there is little on the ground that visually relates them. Unlike the anticipated embracement of the ordinariness, the contrast between Giurgola's romantic sketch and the realism of Victoria Road is striking. Similarly, Giurgola's 1997 axonometric sketch of the various buildings within the site diminishes their differences.

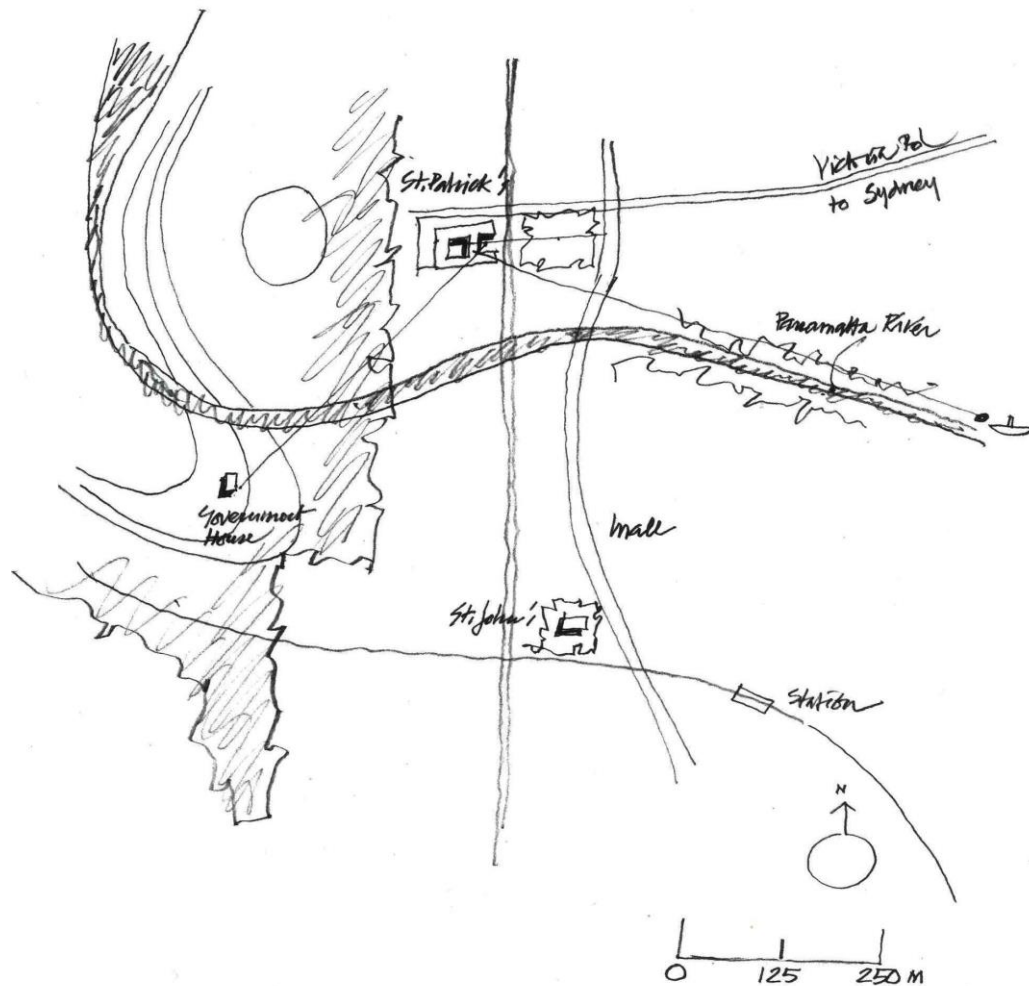

Figure 6.9: Giurgola's site analysis sketch. Undated.

The master planning presented in the Macmillan monograph shows that a number of options were considered for the siting of the new cathedral space. Giurgola states that a decision was reached to re-orient the site to address Prince Edward Park away from its original address to Victoria Road (Giurgola & Berg, 2006) - effectively turning its back on the street's disorder. For inspiration, he focuses his attention on the Our Lady of Mercy College across the Park, which he describes as 'a beautiful chapel designed by J.D. Moore & V.L. Dowling'. He writes, 'I occasionally spent time in that simple chapel during the design of St Patricks, and in its spatial and architectural terms, it provided me with good inspiration for the things to come'. This suggests a disinclination to directly tackle broader questions, preferring instead to focus on a few historical/architectural elements raised out of the suburban nothingness.

Giurgola solution was a re-organisation of the site, augmenting the ruins of the previous cathedral with a new linked space for 800 people at a transverse (east-west) axis aligned through its central transept and a pared back reconstruction of the ruin. The decision to re-orient the central space at cross-axis to the ruin is comparable to Basil Spence's rebuilding of Coventry Cathedral following its ruin during World War II. Rebuilding the Coventry Cathedral carried great symbolic importance for the English nation and Spence's arrival at a crosswise orientation to the ruined cathedral signified a new path of reconciliation (Herbert, 1999). However, unlike Giurgola's restoration of the St Patrick's ruin, Spence's scheme preserved the open-air ruins as a monument to the sacrifices of the war. 'A path, then, from ruins to renewal' (Herbert, 1999). In the site planning process, Giurgola similarly considered retaining the ruins as 'a permanent glorious ruin and walled garden' (Giurgola & Berg, 2006):57, but dismissed the concept as, '...being a somewhat romantic escape from the true architectural and urban design resolution...' (Giurgola & Berg, 2006):57. Instead of amplifying the contrast between ruin and renewal as Spence who 'gave expression not only to humanity's loftiest accomplishments but also its basest deeds...' (Herbert, 1999), Giurgola's cathedral symbolises a curative bond with the past. His attitude reflected the earlier mentioned visit to the prisoner by Father Boyle.

Similarly, the close to equal weighting that Giurgola attributes to both axes signifies his equal consideration of their importance. In Giurgola's scheme, the ruined cathedral retains an equal presence to the new space in an integrated design. Spence's cathedral plan, on the other hand, places greater importance on the introduced axis, and would hence be closer to Farrelly's description of a 'dog legged plan' than Giurgola's. There are similarities between the cross axial arrangement of St Patricks and the earlier, smaller St Thomas, being that the two axes come to represent a reinforcement of the existing site forces overlaid with a second, new interpretation. In the St Thomas church it is the established alignment of the existing presbytery that establishes the initial axis.

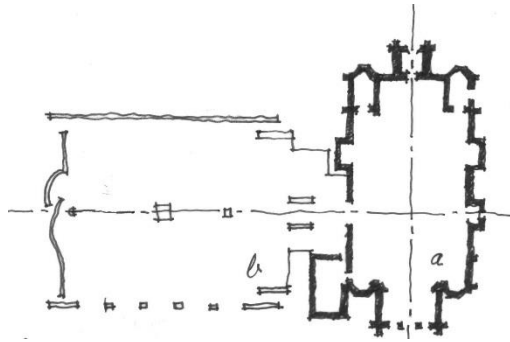

Figure 6.10: Cross axis relationship of the new St Patricks cathedral space

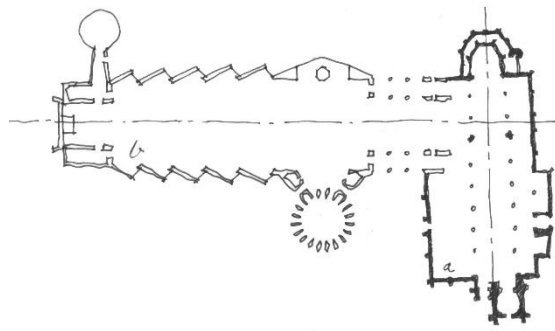

Figure 6.11: Coventry Cathedral plan showing the new space at cross axis to the ruins

The building

A visual diary of sketches presented in the Macmillan publication narrate that at least two schemes were considered for the layout of the plan form. In scheme 1 the seating was asymmetrically arranged in an 'L' shape plan surrounding the altar [Fig. 5]. The Victoria Road (north) wall had 'thickness', recalling Le Corbusier's Ronchamp Chapel, while the south wall was broken, stepping away from an east-west axis on which the centres of ceremonial action were located: font, ambo, altar and cathedra. The opposing south wall, thin and stepped in plan, is evident in Giurgola's previous work, specifically the Volvo Headquarters (1987) and Mission Park Residential Houses (1972).

The successful scheme '2' relied on a plan symmetrically disposed about the third bay of the original cathedral (See figures 6.12-6.13). Seating numbers were equal on either side of the east-west axis. The scheme was a much closer interpretation of a basilica and its rhythmical structure at cross-axis to the ruined church.

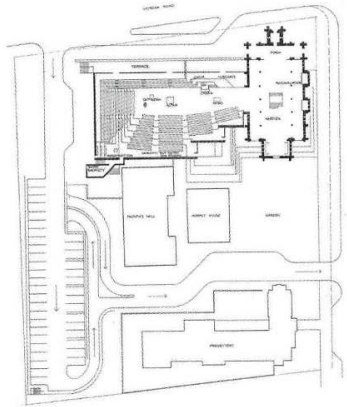

Figure 6.12: Romaldo Giurgola (in collaboration with MGT Architects), *Scheme '1'*, c.1997. The sketch shows an L-shaped, asymmetrical plan and stepped south wall. Church hall retained. Reproduced with permission *Luminous Simplicity: The Architecture and Art of St. Patrick's Cathedral, Parramatta* (Giurgola 2006).

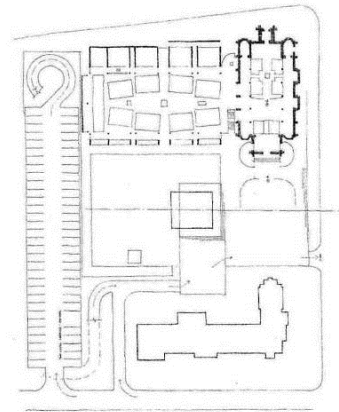

Figure 6.13: Romaldo Giurgola (in collaboration with MGT Architects), *Scheme '2'*, c.1997. The sketch shows a symmetrical plan and demolished church hall. Reproduced with permission *Luminous Simplicity: The Architecture and Art of St. Patrick's Cathedral, Parramatta* (Giurgola 2006).

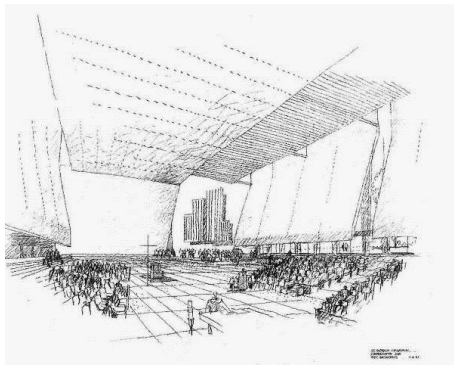

Figure 6.14: Giurgola's sketch, *Scheme '1'*, c.1997. showing the interior perspective of an L-shaped plan and sloping walls. Reproduced with permission from *Luminous Simplicity: The Architecture and Art of St. Patrick's Cathedral, Parramatta* (Giurgola 2006).

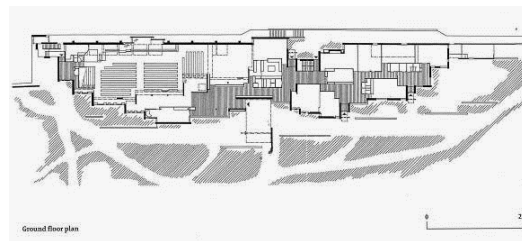

Figure 6.15: Myyrmäki Church, Vantaa Finland. Architect Juha Leiviskä 1984 (published in Stegers 2008)

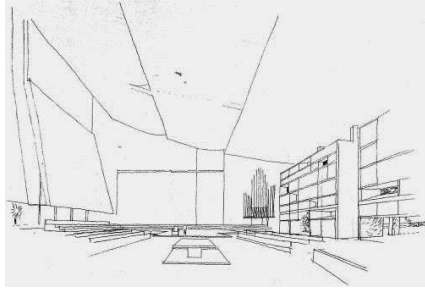

Figure 6.16: Giurgola's interior perspective sketch showing a 'thick' north wall.
 Reproduced with permission from *Luminous Simplicity: The Architecture and Art of St. Patrick's Cathedral, Parramatta*. (Giurgola 2006)

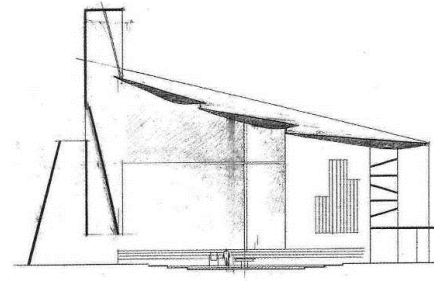

Figure 6.17: Giurgola's sketch section showing 'thick' north wall and backward sloping south wall.
 Reproduced with permission *Luminous Simplicity: The Architecture and Art of St. Patrick's Cathedral, Parramatta* (Giurgola 2006).

It is unclear why the symmetrical plan option was eventually chosen. Giurgola commented that the sloping walls were a cost concern⁴⁰ and abandoned in favour of a simpler structural design. Nonetheless the decision agrees with the pattern evident in Giurgola's work in Australia that has been examined so far in this thesis, which suggests he felt more comfortable with symmetry. But it also goes to his way of working. As at the St Thomas Church in which his first sketches were so strikingly similar to Utzon's church. Sketch plans for St Patrick's feature stepped free standing walls and floating ceilings that appear to echo Aalto and Juha Leiviskä⁴¹. However, in both cases, the more obvious references are removed in favour of symmetry. Giurgola later rescues a spectre of the stepped plan in the design of the church hall and site configuration shown in a later sketch of the site arrangement.

Both schemes preserved a connection with an exterior space. In the case of the stepped plan, the existing church hall was retained and the plan referred to a street

⁴⁰ Personal communication to the author.

⁴¹ Juha Leiviskä (born 1936) is a prominent Finnish architect who came to international attention during the 1970s, 1980s and 1990s with designs for churches in Finland, each employing a consistent design language. Leiviskä's architecture is noted for his adherence to the principles of De Stijl architecture of the 1920s and the way in which he succeeds in dissolving its formal vocabulary by the use of daylight, particularly the use of series of parallel, free-standing walls that define space yet deconstruct traditional notions of enclosure, of which the Myyrmäki Church is an exemplar.

side court. In the favoured scheme 2 (symmetrical plan) the pre-existing church hall was removed in favour of a new cloistered outdoor space. At the St Thomas Church Giurgola had experimented with opening the main worship space to a contemplative cloister, connected, but transverse to the seating. St Patrick's further expanded this concept so that half the cathedral seating had direct views into the cloister through openings in the side wall. The cloister is pushed off axis by the heritage protected Murphy House, shown as 'd' in figure 6.18. The brief, based on the liturgical requirement for community worship, determined that the altar would be centrally located. The centre is thus grounded in the present by the contribution of the outdoor space whose qualities change with the times of the day, weather and seasons - replacing the gravitas for which Stead yearns. Giurgola's sketches show children playing in the cloister.

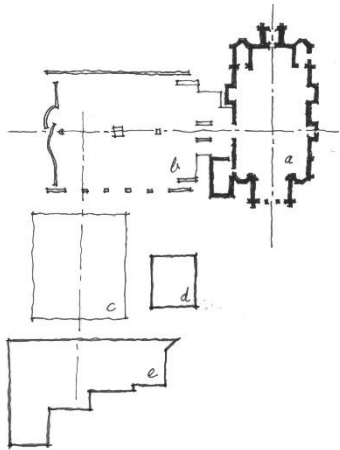

Figure 6.18: St Patrick's site arrangement with cloister (c) to the south of the cathedral space (b)

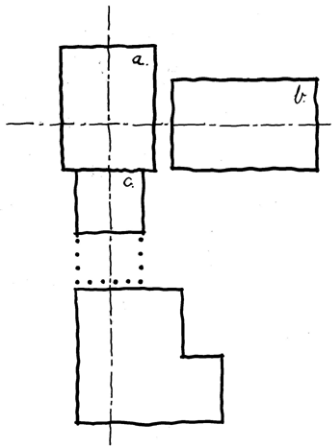

Figure 6.19: St Thomas site arrangement with cloister (b) to the east of the worship space (a)

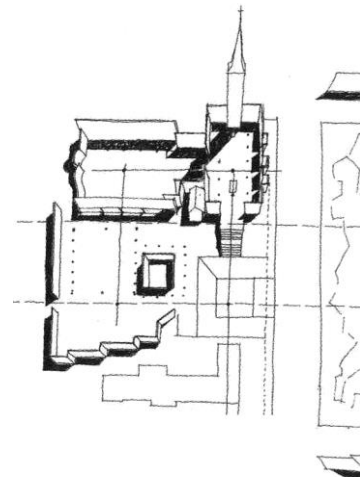

Figure 6.20: Giurgola's sketch of the site showing a stepped church hall. Reproduced with permission from *Luminous Simplicity: The Architecture and Art of St. Patrick's Cathedral, Parramatta* (Giurgola 2006).

The interior Giurgola describes as a 'vessel', which in the Christian sense would contain the essence of a spiritual space through holding light. In the early sketches the metaphor was translated into sloping walls for the nave space. In its final form daylight is introduced into the Cathedral space from three sources: through the

longitudinal skylight centred over the east-west axis; from the top 'edge windows' reflected into the space by the curved ceiling and by penetrations through the screen north and south walls related to the structural elements.

Similar to the St Thomas church, the light was intended to have the changeable qualities of the time and season. Giurgola wrote,

Light remains the true structural element of the space, whether being natural light during the day or carefully-calibrated artificial light at night. In the daytime there are those moments when a controlled sun-ray temporarily penetrates the space, touching the surfaces of objects, walls, doors, the floor, or works of art. It is in those moments that perhaps the aesthetic visio of Thomas Aquinas becomes a reality, giving clarity, integrity and proportion to the Cathedral's space. These moments have a clarity not simply 'in itself' but, in the spirit of Umberto Eco's paraphrasing from Aquinas, are filled with a beauty which is like a state of equilibrium between a perfect object and the intellect.

The combination of these two form-making gestures is clearly quite different from the modern tradition that idealised and abstracted spiritual space, removing it from the landscape. Le Corbusier's Ronchamp or Louis Kahn's First Unitarian Church (1959-1962) – to which Giurgola aspired in his Benedictine Chapel of 1973 – seek to create solemnity by abstraction, not greatly different from the Pointed Architecture which Farrelly and Stead lament the loss of, in which the sign of the divine presence is found in dark space punctuated by shafts of descending light. Instead, although there is the recognizable connection in the formal arrangement of Kahn's or Le Corbusier's concave ceilings, Giurgola's creation of a suspension of reality is more about surface and texture as the conduit of transcendence, a feature of the St Thomas Church and those of Leiviskä or Aalto.

Giurgola seeks to further reinforce the gravity of the space by careful use of materials and shaping of the ground plane. Grading from a black granite floor through blond timber furniture and panelling to a pure white ceiling, the materials reflect visually the transition from the earth to the heavens. In addition to the materials, the floor of transition space between the original church – now sacred chapel – and new cathedral ramps down to a lower floor level containing the sanctuary from which seating plats rise in elliptical arcs on either side. Giurgola (2006) described the intended effect as, 'akin to an amphitheatre'.

At the centre of the section Giurgola makes a gesture towards the sky with a longitudinal skylight, but otherwise the repeated regular section and structure results in a shed-like form larger but flatter than the adjacent original church. The effect is a head-tail relationship, recognised by reviewers as a sign of deference to the importance of the heritage building and its position in the structure of public space. A comparable solution was reached by Aalto for the Enzo-Gutzeit building in Helsinki

by which Griffiths argues that Aalto designed a low flat bar in order to establish a tensile relationship with the Uspenki Cathedral beyond (Griffiths, 1997 p.63).

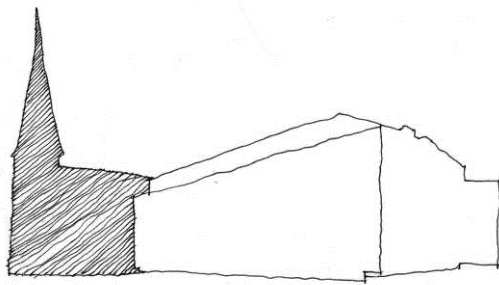

Figure 6.23: St Patricks Cathedral head-tail configuration

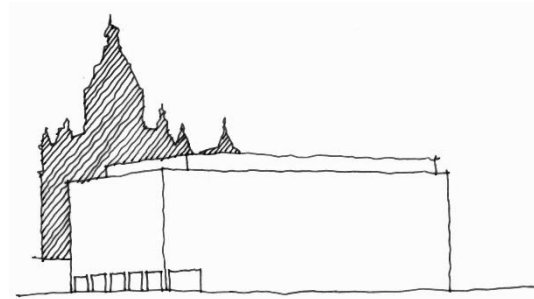

Figure 6.24: Aalto's Enzo-Gutzeit building head-tail configuration with the Uspenki Cathedral

Suspended screen wall

To clad the north and south elevations Giurgola chose a precast concrete panel wall. This exaggerated surface subverts the traditional expectation of a wall bounding an internal space by being detached from its structure and by extending beyond the implied building envelope. Instead of landing on the ground, it seemingly floats above its foundations, creating the illusion that it is unconnected to support. Neither does it seem to support the roof above as a wall traditionally would. To the north, facing onto Victoria Road, it is closed with small square openings at high level, flush glazed, through which the structure beyond is visible, and low slot windows from floor level to knee height. To the south the screen wall repeats the same openings at high level, but has larger lower level openings that allow views and access to the cloister. Rather pragmatically Giurgola comments that the reason for the difference is that 'its solid configuration is necessary as a protection from the traffic-generated noise of the road' (Giurgola & Berg, 2006 p.99). In the same passage, he also explains that the safety of parishioners gathering at the entrance was a consideration when deciding to reverse the entry away from Victoria Road. Giurgola further states that the flanking walls were intended to 'visually extend expressively beyond the limit of the interior space, intensifying and reflecting the longitudinal character of the Cathedral's interior void' and 'contrast with the eventful curves and articulation of east and west walls'.

A detached screen wall appeared in Giurgola's earlier work. The 1970s United Way Headquarters Building (1971) and Sherman Fairchild Center for the Life Sciences (1977) have similar detached free-floating walls. He commented earlier that:

At one time in the past, the corner was very important. It was a basic element of the structure. All of a sudden, the corner didn't have any value as a structure because the concrete was distributing the load to every column in the same way. So, I started to work on that. (Giurgola, 2002c)

Kahn and Venturi also began to deploy a screen wall around the same time. In the layering of dormitory courtyards of the Ahmedabad Institute (1963), at the Exeter Library (1967-1972) (see Figure 6.25), and at National Assembly Complex in Dhaka (1962-1974), Kahn used screen walls as the outer layer. At the National Assembly, Kahn undermined traditional principles of procession and enclosure by wrapping concentric layers of incompletely bounded space around the assembly chamber (Goldhagen & Kahn, 2001). Thus, Kahn's screen walls had to be conventionally grounded in order to affect the experience.

Venturi (1966 p.80) in *Complexity and Contradiction* discusses the differentiation between the interior and exterior of buildings, concluding that 'since the inside is different from the outside, the wall – the point of change becomes the architectural event'. He experimented with the use of a thin screen wall in the 1960s, most evident in his cardboard cut-out models of the era. The most well-known was the unbuilt National Football Hall of Fame (1967). Venturi envisioned a small, vaulted display hall behind a gigantic sign. Venturi called it the 'Bill-ding Board,' on which would be shown images of famous football plays in lights - decades before the work of Diller, Scofidio and Renfro and others who have explored the connection between media and architecture (See Figure 6.31).



Figure 6.25: Exeter Library, Louis Kahn, 1967—1972. Photograph by Jacqueline Poggi, 2011. CC BY-ND 2.0



Figure 6.26: United Way Headquarters Building, 1971. Photograph by Rollin La France. Courtesy of The Architectural Archives, University of Pennsylvania. Ref: aaup.015.V.110.2



Figure 6.27: Detail of Sherman Fairchild Center for the Life Sciences, 1977. Photograph by author.



Figure 6.28: Luigi Moretti's Casa Il Girone, 1949. Photograph by Michael Waters



Figure 6.29: Detail of St Patrick's floating screen wall. Photograph by author.



Figure 6.30: Detail of St Patrick's floating screen wall. Photograph by author.

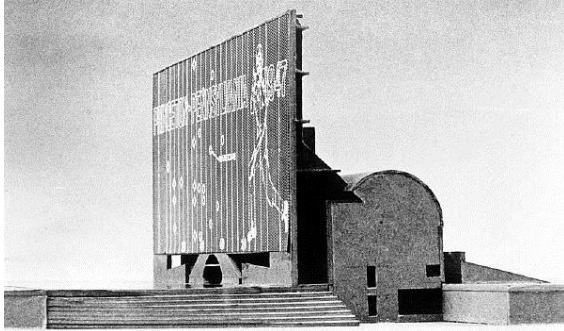

**Figure 6.31: National Football Hall of Fame,
Robert Venturi, 1967**

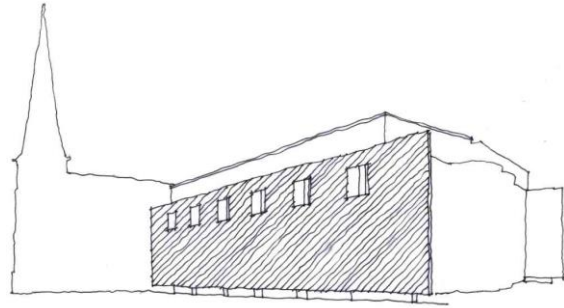

Figure 6.32: St Patrick's screen wall.

Giurgola's screen plays a similar role in layering the space as in Kahn's, but it is more than that, as Giurgola, like Venturi, constructs it as a message board. And yet, Giurgola's message contains little of the ironic interpretation of Main Street sign boards as in Venturi's 'Bill-ding Board'. Instead, its formation is closer to that of Luigi Moretti's Casa Il Girasole that faced the street with a delicately thin façade, like Giurgola's, extended beyond its natural end, emphasising its thinness. Moretti contrasted the free-floating detached wall with a solid rustic base. The effect, according to Roger Sherwood (1985), left the 'impression of a technically sophisticated, crystalline plane emerging from a vine-covered fragment of Roman antiquity'. The ambiguity of the façade led to the building being included in Venturi's book. However, it is a more subtle ambiguity, like Giurgola's, than those of Venturi's media boards.

Giurgola's focus is two aspects: a formal and compositional one in which the screen wall would reveal a truth about modern construction and at the same time undermine it; and that a thin surface is an economic opportunity to respond to the surrounding context. Just as in the two earlier 1970s buildings, Giurgola emphasises the independence of the wall. The surface materials and penetrations of the planar screen walls respond to their context. At the Sherman Fairchild Center, Giurgola clad the face with terracotta tiles; a collage of the surrounding historic campus buildings. In composing the United Way Headquarters screen walls, Giurgola varied size of penetrations to respond to the orientation of the facade. At St Patricks, the pre-cast panel colour and aggregate is selected to respond to the sandstone walls of the existing building.

The screen wall and strip windows of the United Way building were also repeated in the university buildings for the University of New South Wales and University of Adelaide, although at the Red Centre (See figure 1.4), which was a collaboration between Giurgola and Francis-Jones, Giurgola draws a distinction between his sensitivity to structure, and that of the next generation, expressing, for him, the importance of retaining balance in the composition of elements:

That is what I was trying to tell to Richard Francis Jones when we were doing the Red Centre building for the University of NSW, where there are these big beams. I was asking, why do we have to do all that? A beam at that point doesn't make any longer that effort. So you always end up having something simple at the end, very little, you don't need all that concrete. Instead he wanted to do a big beam. But the structure of that guy is not like that, I said, it is like our body. I was saying try to do it more simple. It is too much weight per se. It doesn't need to be that big to support what is on top. That is what happens when you think in aesthetic terms, formal terms, before thinking of it an organism (Giurgola 2007).

Of the Australian works, St Patrick's is Giurgola's most pronounced use of the floating screen wall device. The veneered surface at the front of Parliament House was criticised for its thinness, in the St Patrick's Cathedral has a different effect. As in the St Thomas Church, the Cathedral screen wall Giurgola creates a visual gestalt figure/ground shift - a calculated discontinuity - to create subtle a ambiguity by which the building's external surfaces hover between the transiency of modernism, and the eternal and immovable of the Gothic. Giurgola has sought to subvert the role of the wall without losing its legibility – as in the jarring, complex fragmentation of the Deconstructivists.

The tension that Giurgola creates is repeated internally through the building's details. Where the internal column meets the roof beam, for instance, the structure is a steel portal frame concealed beneath plasterboard cladding, but Giurgola is at pains to make the support appear to be a short cross wall with just enough of the roof beam sitting atop the wall to carry it. To amplify the apparent fragility of the connection, he

scribes a relief line into the surface. Any less overbearing of the beam would be perturbing, any more would strengthen the appearance as a portal frame. The result is a little unnerving and provokes that sense of tension achieved in the external screen walls.

The pattern is repeated in the design of the pews. Giurgola selected designer/maker Kevin Perkins to collaborate on the cathedral furniture and the internal cladding of the building. Perkins had a good working relationship with Giurgola, having worked on Parliament House and St Thomas Church. Using a technique of laminating sections of timber, the pew seat and its back and kneeler are extended, cantilevered, well beyond the vertical end support so that the horizontal elements appear to be free floating in the space, repeating the earlier arrangement of the exterior screens of Condon Hall (See chapter 4). Extensive prototyping and testing was undertaken to provide, again, ‘just enough’ structure to achieve the floating appearance and so that kneeling or sitting was comfortable.



Figure 6.33: Junction of blade wall and roof beam. Photograph by Hamilton Lund. Reproduced with permission from *Luminous Simplicity: The Architecture and Art of St. Patrick's Cathedral, Parramatta*. (Giurgola 2006:83)



Figure 6.34: Junction of blade wall and roof beam. Photograph by Wade Bartlett. Reproduced with permission from *Luminous Simplicity: The Architecture and Art of St. Patrick's Cathedral, Parramatta*. (Giurgola 2006:169)

In the redevelopment of the ruined cathedral, a third detail of note is the timber screens that floats over the altar and tabernacle which is in the form of a seed pod, a

design by artist Robin Blau. The screen is made in four overlapping curved pieces constructed from bent timber veneer over a concealed timber and steel skeleton. Three alternative configurations were developed and tested in the design phase of the screen. In the initial phase Giurgola sketched the three alternatives in elevation. Then each of these was tested through a physical 1:20 model and computer model for discussion with the design team.⁴² Giurgola's favourite was a screen that was two symmetrical pieces each sliced through the centre and pulled open like a tear in fabric.⁴³ Technical difficulties in bending plywood in two directions reduced the preference of this option, and the simpler curtain like form was selected. In any event, the effect, like the architectural details, is a little odd, but not so that it is unsettling or incongruous. The complete apparent suspension of the timber screen in a curtain form serves its practical purpose of providing a layered conclusion to what would have otherwise been a blank stone wall, and focus to the tabernacle below. Giurgola explains that the suspended screens are intended to, 'give visual focus to the Chapel's Altar and the Tabernacle below'. The curvature, he goes on, 'was intended in visual terms to receive and complete the spatial thrust of the main nave of the Chapel by creating an adequate palpable depth of space...' (Giurgola & Berg 2006). But it is the combining of a reference to the temple curtain with a blond timber veneer, a favoured surface of modern architects, which yet again creates a curious but subtle tension by the double encoding of historical reference with a modernist aesthetic. The more perceptible use of a screen/curtain motif in the chapel also provides a clue to the curved and overlapping end walls in the new cathedral space which through this lens can be read as coded with notions of renewal.

⁴² The author provided model building and drawing work to support design development of the interior details of the chapel.

⁴³ Perhaps a biblical reference to the Gospels' report that amongst other supernatural events, the veil of the temple was torn in half at the death of Jesus (Matt 27:51; Mark 15:38; Luke 23:45). Theology scholars debate whether this rending of the temple veil is indicative of the new access that all believers have to God through Christ, or whether it is symbolic of the departure of God's blessing and the destruction that will come upon the temple. Had it been implemented, Giurgola's split screen invites readings about the renewal of the burned cathedral.



Figure 6.35: Interior of the renewed chapel showing the timber screen. Note that the central timber box is a later addition. Photograph by author.



Figure 6.36: Detail of the end wall of the cathedral. Photograph by author.

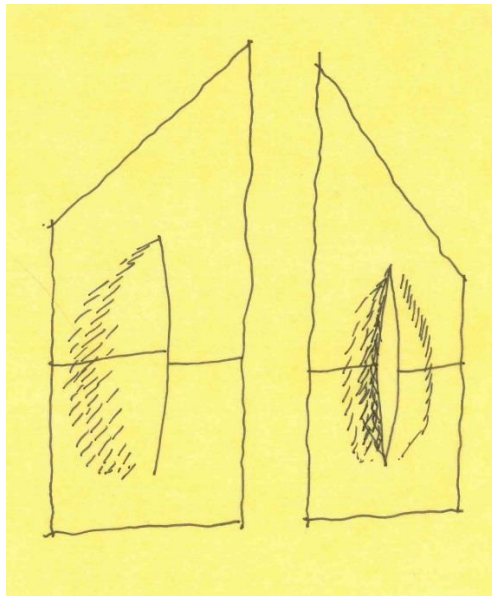

Figure 6.37: Sketch of Giurgola's preferred design of the chapel end screen (by author).

Artists and artisans

As he had done in the parliament building and at St Thomas, Giurgola collaborated with artists and craftspeople to produce elements of the cathedral interior. Metal screen gates, altar, baptismal font, sacral furniture, pews, and stained glass windows

are amongst a number of commissioned elements of the building. Like Kevin Perkins, many of the artists had worked with Giurgola on previous commissions.

The role of the artists, as Giurgola saw it, was to 'convey a resonance of content and meaning within the Cathedral' (Giurgola & Berg, 2006 p.133). He explains that his goal was for a 'close integration of architecture with the works of art and craft' to make a 'unified whole, rather than a piecemeal collection of different styles and aspirations'. In order to achieve this aim he organised the team of artists parallel to the design development of the building, thereby, he explains, 'allowing a creative cross fertilisation between the architecture and the art'.

Robin Blau's Cross with Corpus sculpture is an example of the collaboration producing works. The 5 metre high Cross and Corpus is the central element of the new cathedral space axis. The Corpus is constructed of curved stainless steel rod, sheet and plate stainless steel, taking nine months to fabricate. Blau's work, following from the requirements of his brief for an image of a 21st Century Christ, is a Corpus whose muscles are taut and strong. Giurgola comments that the removal of the central portions of the Cross's horizontal bar while retaining its massive terminations, 'gives visual emphasis to the head and expression of Jesus' (Giurgola & Berg, 2006 p.162). An alternative reading of its configuration is the artist's response to the established pattern of Giurgola's tensile architecture.



Figure 6.38: Cross and Corpus (Giurgola 2006:163).

The quiet subversion of St Patricks

The symmetrical glass and concrete box appearance of St Patricks is ostensibly a return for Giurgola to a classical modernism – symmetrical, controlled and ‘polite’. Its reviewers displayed some unease about how to reconcile the parliament building with the apparently new Australian Giurgola, placing the cathedral alongside similar neo-modern works by the new generation of Sydney architects. None mentioned the parliament as a precedent work. The second anxiety was with the building’s refusal to neatly fit the neo-modernist model. Whereas the modernist tradition called for an a-contextual response, such as that achieved by Kahn and Le Corbusier, or indeed the Cathedral of Our Lady of the Angels by Rafael Moneo in Los Angeles (2002) - completed around the same time as St Patricks - removing the inhabitant from the context, Giurgola’s building is designed as a conversation with the old cathedral and its physical context. There is also Giurgola’s idiosyncratic view of the Renaissance citizen that is overlaid on both the parliament building and the cathedral.

The existing ruined building by its elaborate neo-gothic detailing and tower (although ruined) was going to be a dominant visual element of the site. And yet, Giurgola was to build a cathedral space which would house the main assembly in a new building.

At the same time, a use had to be found for the ruin that was compatible with its cultural and physical presence. Unlike Spence's solution for the reconstruction of the Coventry Cathedral which emphasised the ruin, physically and symbolically, Giurgola sought to incorporate the ruin into a cohesive whole. On the other hand, Spence's solution provides a stark contrast to the ruined building, emphasising difference: the relationship with the past was fixed in the physical and metaphysical dimensions. In Spence's work, the new responds to the ruin but not vice versa. In St Patrick's, the 'rehabilitated' ruin responds to the new as well.

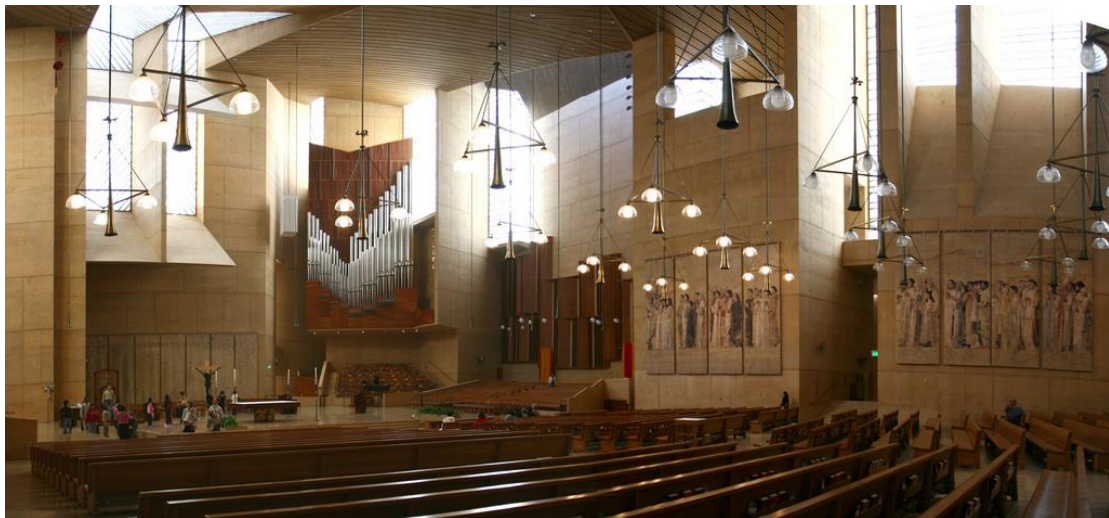

Figure 6.39: Cathedral of Our Lady of the Angels, Rafael Moneo, 2002. CC BY-NC-ND 3.0

Looking at the outward form of the cathedral Giurgola has used a number of practiced devices to stitch the new cathedral space into the site context and with the ruin. He contrasts its orientation and form to the re-built outer form of the Gothic Revival Church and by keeping the building low and flat the head-tail arrangement ensures that the focus is the reconstructed Pugin-inspired tower; re-enforcing its place in the community as a sign of its importance. Then, to give the new cathedral building its own defining presence, Giurgola introduces a tension which is comparable to the earlier St Thomas Church. There is not the same expression of decay or the ordinary in the design as there was with St Thomas in response to the suburban context; the modernist box is exploded— the screen wall floating from its structure, floating roof beams, ceiling and pews – but held together by 'just enough'. The result is the controlled use of light between the elements which differentiates the building from the interior spaces of the darkened neo-gothic cathedral. The choice of materials also

plays a role in this differentiation: the exterior screen colour, and internally, are soft, naturally finished materials, similar to those of the Scandinavian tradition – dark floors, blond timbers and white walls.

Through these devices, Giurgola puts the architectural elements, including the works of art, into a responsive conversation with their context. Giurgola's careful selection of salient features of the site's context are those which he believes have historical and architectural value; those that align to his idiosyncratic view of citizenship and religion, his inspired way of life that was imagined quite separately from that of Louis Kahn. Kahn tended to mythologise the past whereas Giurgola demonstrates an ongoing dialogue with historical forms, part of his conversation with context. Giurgola's world view, as expressed in the cathedral, is also quite separate from the collage of media and architecture that Robert Venturi suggested to engage in a dialogue with history. For Giurgola, not everything about Parramatta Main Street was 'almost alright'. And yet, there are elements such as the intentional misalignment of structure and window opening, recalling Asplund's play with openings at Villa Snellman, that are quietly subversive. At this middle point between recalling historical norms, be they classical or modernist, and extravagant subversion, the design of the parliament building and the cathedral are brought closer together. In both buildings, though by different formal expression, Giurgola introduces a sense of the continuous overlay of historical forms, slightly transformed.

Chapter 7 RG House, Lake Bathurst, New South Wales (2002-2003)



Figure 7.1: Lake Bathurst House. Photograph by John Gollings. Used with permission.

In a sketch of the house Giurgola designed for ‘...my daughter, myself and a dog...’ in the Great Dividing Range overlooking Lake Bathurst he depicts a lone figure (See Figure 1.12), seated at a desk, not facing the wide scenic valley below, but at work with the view to his left. Immediately there are comparisons to the summer retreats of Le Corbusier’s Cabanon, and Aalto’s summer house. Its square plan, slashing diagonal and temple like roof have also led to comparisons with the villas of Palladio, and with Le Corbusier’s Villa Savoye of 1929-30 with reference to Colin Rowe’s (1947) earlier celebrated essay, ‘The Mathematics of the Ideal Villa’ (Beck and Cooper 2003). For others the spirit, or ‘total experience’, of the house derives from Giurgola’s nomadic condition and his adaptation to the Australia’s diverse culture and conditions (Favaro & Manasseh, 2011).

And yet, while it is acknowledged that Giurgola’s time with Kahn has bearing on the design of the house as a room (Favaro & Manasseh), the heritage of the house plan in the ambiguities and contradictions of the American post-modern take part in what Giurgola brings as his particular cultural baggage to the design. Likewise, his

attraction to forms of modernism in the colder climates of Northern Europe, a key ingredient in the house, is largely overlooked.

A detailed look at the form and site context of the house will be undertaken in this chapter to draw out the other influences on its design. Underlying devices will be analysed by comparison to Giurgola's earlier buildings to investigate their origins and variation when used in the Australian context. The study is informed by original documents, interviews with Giurgola and several visits to the house with him during and after construction.

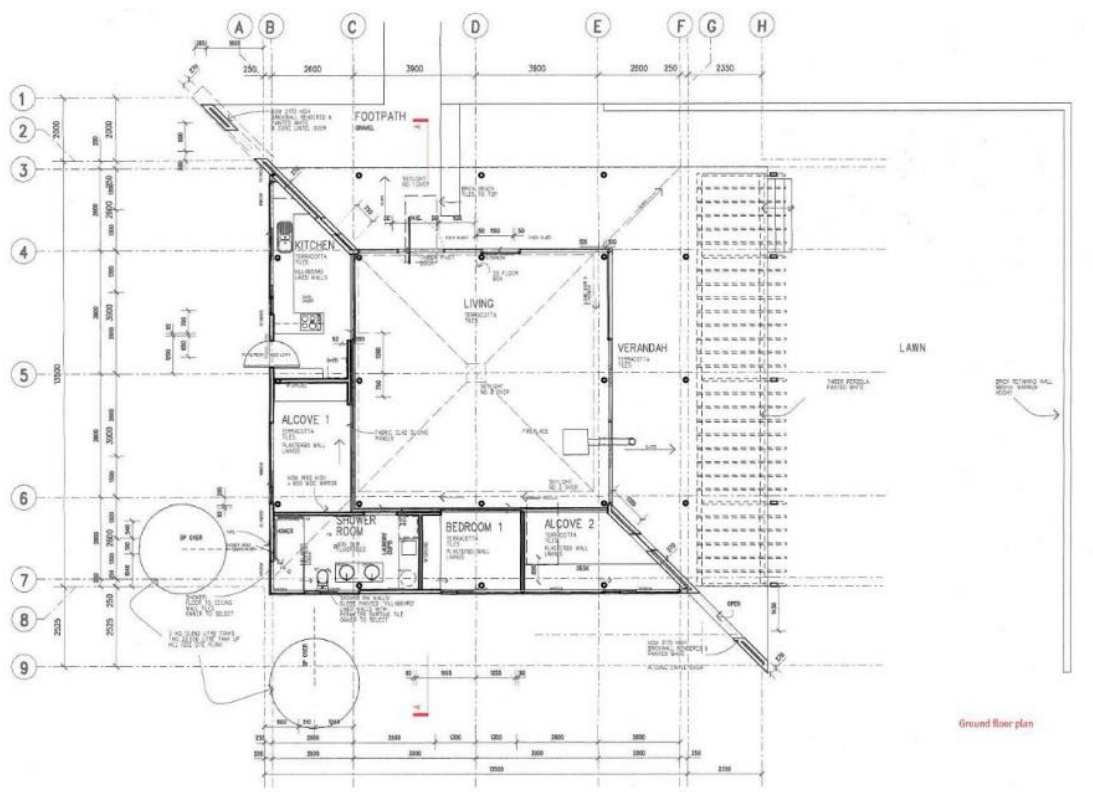

Figure 7.2 RG House Plan (pergola not built), c.2002.

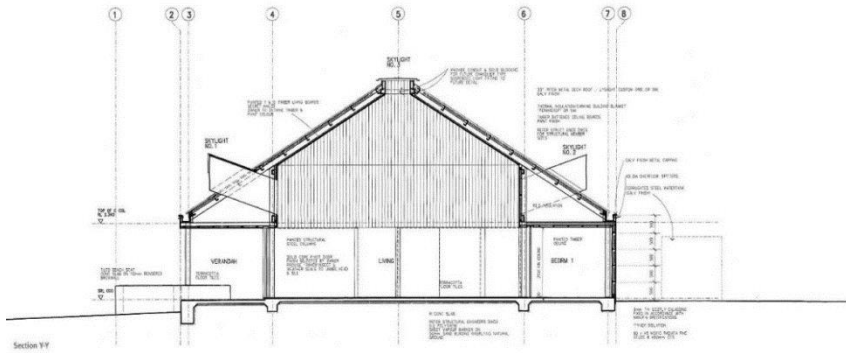

Figure 7.3: RG House Section, c.2002

Critical review

Giurgola's small house was sparsely reviewed in architectural media. Australia's *UME* magazine (Haig Beck & Cooper, 2004) interpreted Giurgola's house through the lens of the 'ideal' villa with reference to Colin Rowe's 1947 essay comparing the mathematical and geometrical relationships between Palladio's Villa Rotonda of 1565 and Le Corbusier's Villa Savoye of 1929-30. While Beck and Cooper are less interested in mathematical comparison, they claim that Giurgola's house is a third interpretation of the 'ideal' villa that combines ideas from both antecedents. From Palladio... and from the Villa Savoye, the diagonal.

Meanwhile for Paola Favaro and Cyrus Manasseh (2011) Giurgola's house creates Joseph Rykwert's 'total experience' by responding to and drawing in the local climate and physical landscape. Giurgola, they claim, has progressively adapted himself through the making of his previous buildings in Australia and his cultural identity reformed by the Heideggerian notion of 'dwelling'.

According to its reviewers, the inhabitant's relationship to the surrounding landscape is central to understanding the house. For Beck and Cooper, Giurgola's arrangement around the diagonal that divides closed cellular spaces from the large open ones is similar to the Le Corbusier arrangement of the

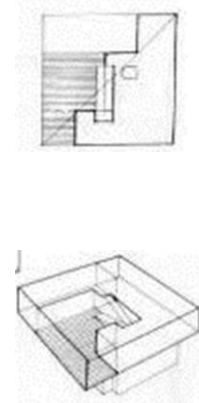

Figure 7.4. Le Corbusier's Villa Savoye, 1929-1931. Diagrams taken from Beck & Cooper (2004)

Villa Savoye but instead of ‘...an abstracted idea of the inhabitant removed from the landscape, physically and metaphorically’ Giurgola’s villa is closer to Palladio’s interpretation of the ideal villa at the Villa Rotonda in which ‘the owner is placed at the centre and in command of his world... is quite literally connected to the landscape and at the centre of it: a humanist idea’. While the ground floor of Giurgola’s house is not raised up on a plinth, the platform on which the house sits operates to ‘...embrace and gather up its surroundings...in much the same way as the Villa Rotonda’ (Haig Beck & Cooper, 2004). The combined effect of the devices Giurgola has drawn from Le Corbusier and Palladio locates the inhabitant, ‘between earth and sky, grounded, with his back comfortably to the ‘cave’ (the private cellular spaces, while facing ahead to the prospect’. Giurgola’s pyramidal roof form, they go on to state, makes the house a temple form, a second interpretation of the Pantheon that inspired Palladio, ‘an objective which is of no concern to Le Corbusier’. In a final note to its Australian context Beck and Cooper (2004) remark that the approach to Giurgola’s house is off-centre, distinct from the Palladian central and axial entry, suggesting, ‘both the informality of Australian houses, and also perhaps an Aboriginal idea of approach, which is oblique and reverential rather than formal and direct’.

On the other hand, for Favaro and Manasseh (2011), the inhabitant is more closely linked to Giurgola and his personal story. They characterise Giurgola as a nomadic figure who via his three-part journey, through Italy, the United States and final years in Australia has developed an intuitive ability ‘for being able to identify broadly with a universal order of architecture’. However, unlike the ‘dwelling’ of Rykwert which is linked to a geographic marker, Giurgola’s dwelling is an intellectual *habitus*. This adaptability to place allows Giurgola to see ‘straight to the truth of the project’ which they term ‘*contenuto*’, a content that is a constant factor in architecture in any place and culture. Favaro and Manasseh attribute the configuration of the main living room, which is made distinct from the smaller service spaces, to Giurgola’s association with Louis Kahn, and Kahn’s conception of a room as the ‘place of the mind’ (Kahn 1971, quoted in Favaro and Manasseh 2011). The constructed ‘spiritual aura’ of Giurgola’s room thus enhances the beauty of the natural environment that surrounds it. Equally so, the strong geometry of its plan and external form contrasts with the environment so that ‘within the flux of ever changing elements a form does not change but endures

with an undying and timeless perfection'. For Favaro and Manasseh, the purity of the geometric form of the house amplifies the natural beauty of the place by providing a focal point in an otherwise monotonous Australian landscape.

A country house

In 2003, during a walk to the top of the densely wooded hill behind the house, Giurgola commented that he considered two potential locations for his getaway house. The first was atop the wooded hill and the second, and eventually favoured location, was on a clearer patch of ground on the hill's saddle, about 100m down from the peak. On settling for the latter position, Giurgola commented that he considered a range of practical reasons such as access to electrical supply, the steepness of road access, tree clearing that would be needed, as well as a quite detailed consideration of the view.⁴⁴ The most jarring factor in the view from the top of the hill was a high voltage power line that ran across.

On the lower elevation site Giurgola established a rectangular, flat platform part cut into the slope and part elevated, retained by a bounding masonry wall. The house is a square plan, sited to the back (hill) end of the platform – a square within a rectangle. The remainder of the flat terrace set in front of the house is informally grassed and frames expansive views across the farmed valley below to the Morton National Park beyond.



Figure 7.5: Sketch context elevation. Drawn by Romaldo Giurgola, c.2004

⁴⁴ Personal communication to the author.

Australian architect, Brit Anderson (2011), in describing ‘ancient gathering spaces’, has written that the raised platform is a place for ‘surveying and contemplating, of power and dominance’, of permanency. It has a dual purpose as a place which represents separation and ‘authority and power’ as well as a place for contemplation ‘where the world is ordered or from where the complexity of the world may become more intelligible’. Replacing the *piano nobile* of the Palladian villa, Giurgola’s platform is thus a symbol of his permanent habitation, ‘between earth and sky’ (Haig Beck & Cooper, 2004) and is closer to the distinction reached in Jørn Utzon’s architecture which Frampton described as ‘earthwork versus the roofwork’ (Frampton, 1995).

In Giurgola’s plan the proportional relationship of the square to the rectangle of the platform on which it sits is 1:2 and does not appear to have any special significance, except that it is approximately two squares. Internal to the house, the separation of space dimension (of the servant spaces) from large dimension (of the main room) at a proportion of 1:1.3, and the main room is a square plan with a proportion of 1:1 with its height. The proportions of Palladio, on the other hand, were specific and intended. Thus, in arranging the site, Giurgola does not appear to establish any special proportional relationship between dimensions that could be understood to be a close relationship with the mathematics of Colin Rowe’s compositional ‘rules’ within Palladio’s 16th Century villas and those of Le Corbusier’s 20th Century villas at Poissy and Garches.

Nevertheless, Giurgola attributes part of his architectural education to his wandering around the Italian countryside. Giurgola’s conscription into the Italian army engineer’s corps in the Second World War gave him the opportunity to experience the Palladio Renaissance Villas. During the long breaks between service duties he describes his formative experiences of the Palladian villas. He states,

I was stationed in the north, between the south of Milan and the Po River because we were training to do bridges. The army always has this period when no one knows what to because you are waiting for an order that never comes, or as it comes already it is dismissed. We were mostly architects in that regiment. It was the regiment of

pontieres. We all understood each other very well. There was someone who was doing the thesis and we all helped to do the drawings. Then it became tough when we had the bombing in Milan. I was sent to Venezia... One of the officers was Pier Luigi Nervi.

My training was really done in that way. It was the first time that I saw Palladio. I was twenty, twenty-one. Palladio I walked all over. It was along the Brenta where there were all the villas. I was going all over by foot as there was not much transportation (Giurgola 2007).

As Giurgola transitioned to the United States, it is also claimed that Kahn had Palladio particularly in mind when designing the Trenton Bathhouse of 1955. In a 1955 journal entry Kahn titled, ‘Palladian Plan’ he wrote, ‘I have discovered what everyone else has found, that a bay system is a room system. A room is defined by space – defined by the way it is made.’ The publication of Rudolf Wittkower’s 1949 mathematical rationalisation of the Palladian geometry made a syntax based Renaissance accessible to American architects. Wittkower’s second revelation was Palladio's formulation of new building types from ancient models, and therefore also offering strategy for appropriation in which ancient forms and quotations could be brought into homogenous wholes (Payne, 1994). The architect William S. Huff was a student of Kahn’s and worked in his office in the 1950s. In a 1981 article, “Sorted Recollections and Lapses in Familiarities,” Huff wrote:

At that time too, an important book came out – Wittkower’s Architectural Principals in the Age of Humanism. Everyone fell over himself to try to grasp it. Palladio was raised to new interest. Palladio meant one thing to Philip [Johnson] - it meant things about proportion and composition. Lou discovered something else in Palladio.

In Palladio, Lou saw the “servant” spaces. He saw that the Villa Rotunda was a great space which he called the “master space” and which was served and surrounded by spaces where the servants were. Kahn saw the analogy with modern times. We no longer have rooms with human servants in them. We now have many spaces with mechanical servants that do the same work that human servants used to do.

Thus, according to Huff, one of the great principles of Kahn’s architecture; ‘servant’ and ‘served’ rooms, came from Kahn’s unique way of looking at Palladio. On the other hand Goldhagan (2001), although acknowledging the resemblance of a Renaissance motif, sets aside the relationship of the Trenton Bathhouse with Palladio, claiming instead that Kahn and his partner Anne Tyng’s primary focus in conceiving the Bathhouse plan, ‘was to continue their exploration of the architectonic possibilities of techno-organicism.’ Whatever the source, Giurgola’s RG House owes a great deal to Kahn’s concept of servant and served rooms as well as the vaulted pyramidal roof, and tartan grid that Kahn and Giurgola exploited.

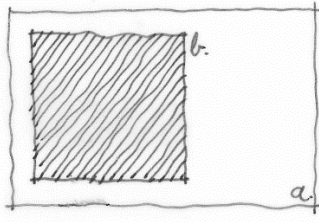

Figure 7.6 Platform (a) to house footprint (b).

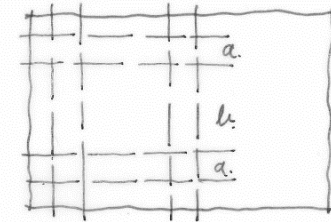

Figure 7.7 Tartan grid of Giurgola's house plan.

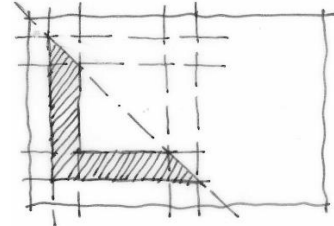

Figure 7.8 Overlay of the diagonal and the division of servant to served room.

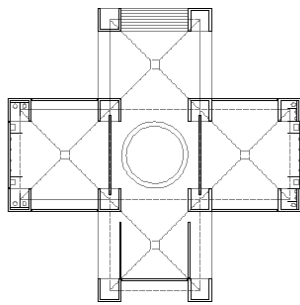

Figure 7.9 Plan of Kahn's Trenton Bath House (1955).



**Figure 7.10 Interior of the Trenton Bath House.
Photograph by Jon Buono CC BY-SA 3.0.**



**Figure 7.11 Interior of the Trenton Bath House.
Photograph by Jon Buono CC BY-SA 3.0.**

The second organising device of Giurgola's plan is the diagonal, a device that is synonymous with Giurgola's architecture. At one point it caused architect Philip Johnson, infamous for incorporating others' ideas, to exclaim, 'I've got your angles! I've got your angles!'⁴⁵ Slicing from corner to corner in the RG house it is the spatial division between private and living spaces, and extends beyond the enclosed space, obfuscating the difference between inside and outside at the corners of the main room. Giurgola (2003) commented that the wall is aligned to two large trees that he

⁴⁵ Quoted by Giurgola (2002) in an interview with the author.

preserved from the pre-existing landscape, demonstrating his concern with connecting the building with its natural context.

The pattern of diagonal began in early Mitchell/Giurgola schemes. From the 1962 Boston City Hall competition bid that brought the fledgling firm to prominence, through the 1970s, up until the Australian Parliament, the diagonal is apparent in various guises. In the White Residence of 1963 the diagonal served occasionally to break open the corner of a room. In the same year in the unbuilt Patzau Residence the diagonal is the entire organising device for the layout of the spaces. The Patzau house was published in *Perspecta 9/10* (1965) whose cover depicts a composite of the plan of Charles I's palace at Granada (1527-68) and Kahn's preliminary scheme of the First Unitarian Church in Rochester (1959) spliced together by a diagonal. Their plans are a square perimeter of cellular rooms surrounding a large circular space in the centre, and both plans share the exact same proportions with regard to the relationship of circle to square. In devising the cover image *Perspecta* editor, Robert Stern, most likely noticed the similarities between the plans presented in Robert Venturi's contribution inside the publication, 'Complexity and Contradiction in Architecture: Selections from a Forthcoming Book'. The suggestion of the image was that modern architecture can be modern without loss of the things that we liked about the past.

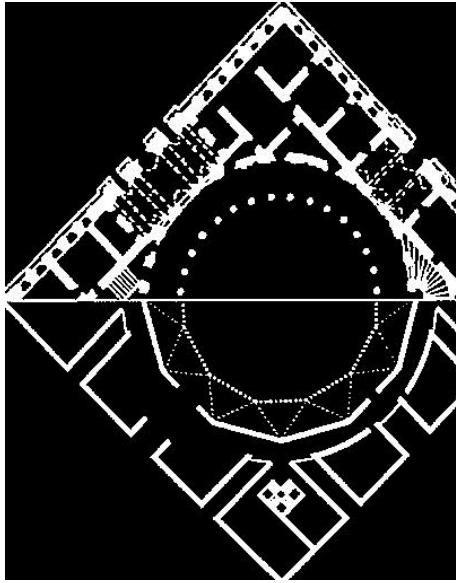

Figure 7.12: Cover image of Perspecta 9/10 (1965)

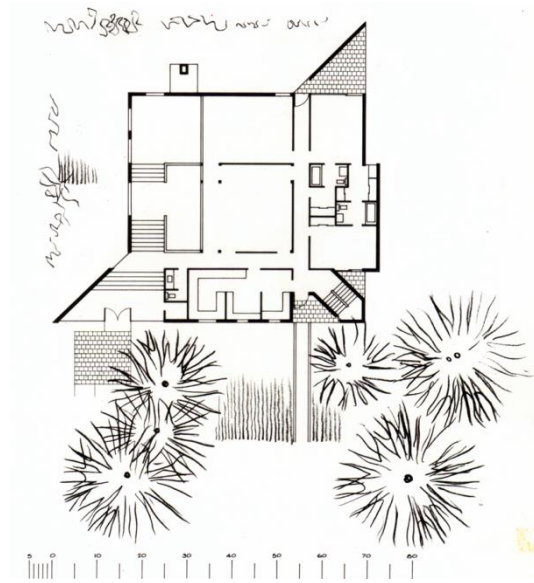

Figure 7.13: Plan of house for Mr. and Mrs. Otto Patzau. Drawn by Romaldo Giurgola, 1963. Courtesy of The Architectural Archives, University of Pennsylvania. Ref: aaup.015.V.066.1

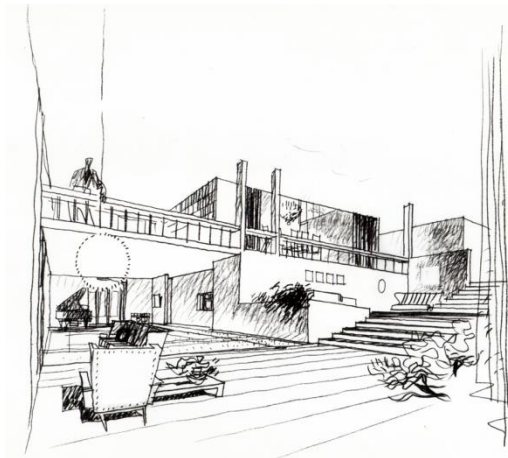

Figure 7.14: Interior sketch of Patzau House. Drawn by Romaldo Giurgola, 1963. Courtesy of The Architectural Archives, University of Pennsylvania. Ref: 267.II.A.

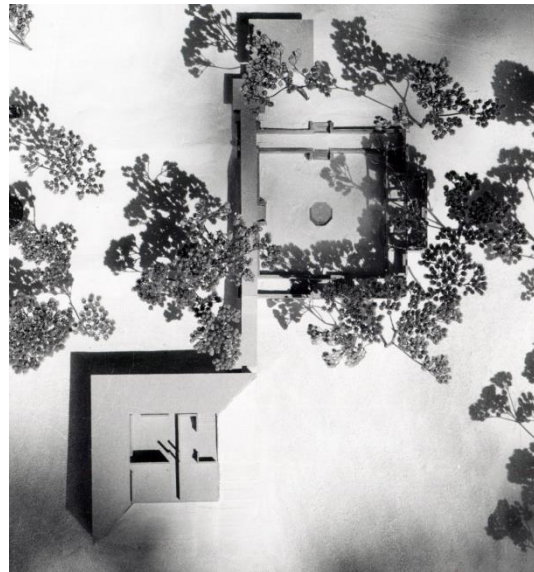

Figure 7.15: Model of house for Mr. and Mrs. Otto Patzau. Courtesy of The Architectural Archives, University of Pennsylvania. Ref: aaup.267.II.A.93b

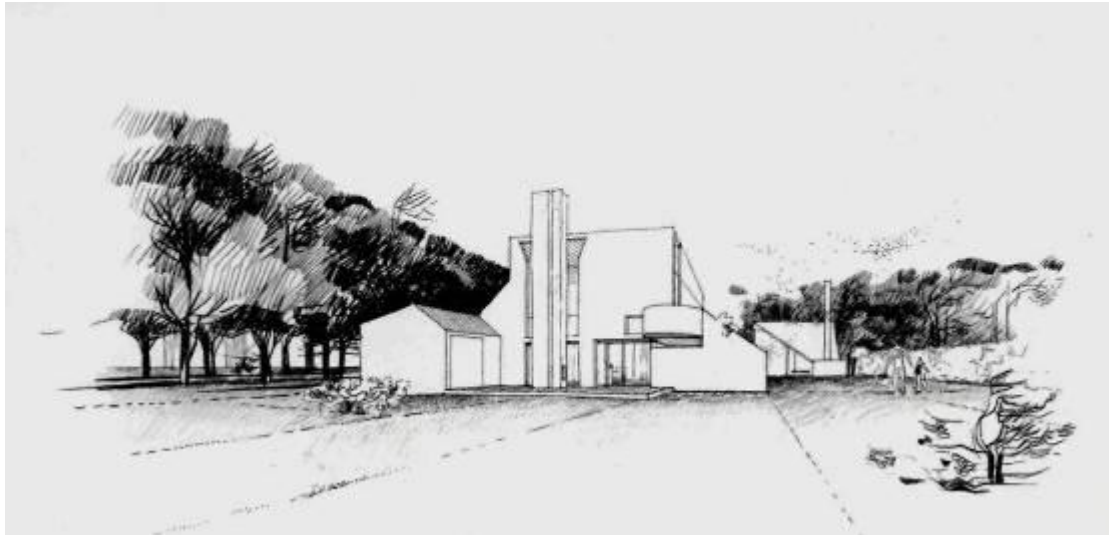

Figure 7.16: Giurgola's sketch of the unbuilt Retreat House, Sweden, 1977. Courtesy of The Architectural Archives, University of Pennsylvania.



Figure 7.17: Model of the unbuilt Retreat House, Sweden, 1977. Courtesy of The Architectural Archives, University of Pennsylvania.



Figure 7.18: Plan of the unbuilt Retreat House, Sweden, 1977. Courtesy of The Architectural Archives, University of Pennsylvania.

The cover image of *Perspecta* could well be taken as the *parti* for the Patzau House, and later R House, in which Giurgola deletes the servant spaces on the opposite side of the diagonal to open the central space to the view.

Meanwhile, Kahn's experiments with the combination of the diagonal and the palazzo began in the Goldenberg House (1959), opening the corners of the palazzo plan, and further developed the concept in the dormitories at Bryn Mawr (1960-65) in which three square plans are rotated at 45 degrees and interlocked at their corners. The central halls are linked along a diagonal axis, which was a new twist on the palazzo motif.

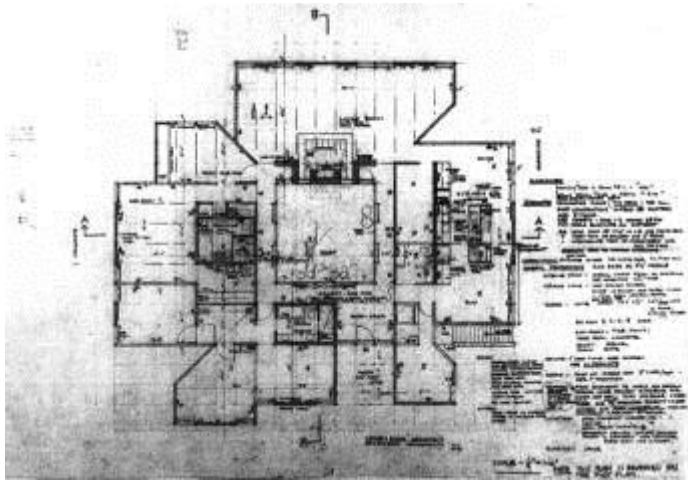

Figure 7.19: Goldenberg House, 1959. Louis I. Kahn Collection, University of Pennsylvania and the Pennsylvania Historical and Museum Commission

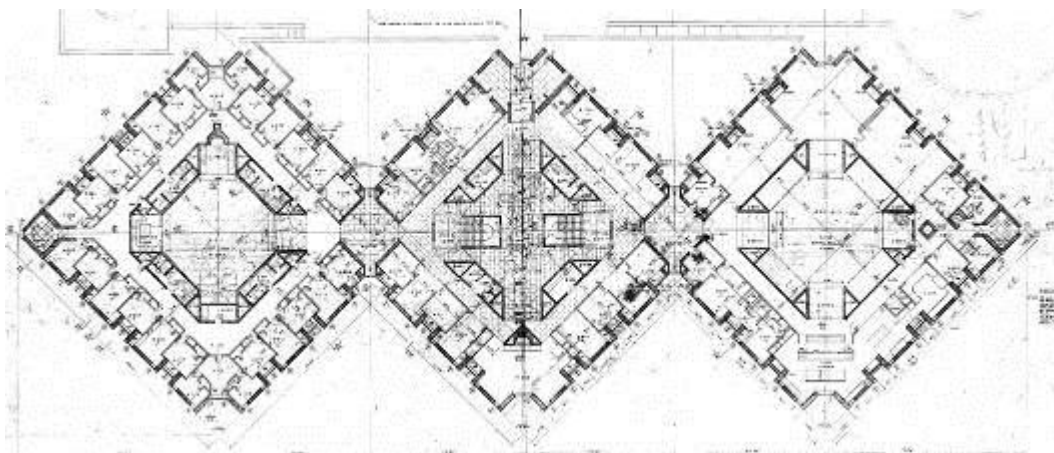

Figure 7.20: Dormitories at Bryn Mawr, Kahn, Louis I., 'Plan of Erdman Hall, Second (Entrance) Floor', 1965. Erdman Hall Documents. Paper 1. http://repository.brynmawr.edu/erdman_docs/1

In 1977 Giurgola adopted a similar arrangement strategy for the Benjamin F Feinberg Library at Plattsburgh. A year later, Giurgola made a further riff on the earlier Patzau house for a 'Retreat House' in Sweden, 'Northern European in Design' (1977). Writing of the Swedish house, Giurgola (1983 p.41) recalls Kahn's room, 'A house as a single room surrounded by places in which to study, to sleep, to play'. The design was never executed and it is said that it was intended as the home for the mistress of

‘a far northern European automobile manufacturer executive’⁴⁶ which may suggest why it was identified as Northern European in design. The retreat house and the earlier Patzau House are clearly the antecedents of Giurgola’s Australian get-away.

While the RG House is much indebted to Kahn’s concept of the served room, Giurgola’s deletion of the second wing of servant spaces is where they depart. Kahn’s palazzo, although subverted by the plan rotation and oblique entries, is perceived as a whole. The main atrium spaces are wrapped on all sides by their servant rooms. Giurgola’s, on the other hand, is a ruined adaptation of the ‘difficult whole’ in which the diagonal provides the inflection.

Approaching the RG House from the gravel driveway, a path is made from simple stones and passes between a low seating wall and the diagonal wall. Suspended atop slender columns is a simple pyramidal roof, it gives a similar impression to the proportions and primitive form of the Skogskapellet cemetery chapel, designed by Gunnar Asplund. The path leads up to a timber door crafted by Kevin Perkins from Giurgola’s favoured blonde timber, Tasmanian Oak. The same timber was used in the Prime Minister’s office of the parliament, and to clad the interiors of the St Patricks Cathedral. It is a heavy door that swings on a pivot, like those favoured by Le Corbusier. Above, the verandah ceiling is clad in matchboard timber. On a visit to the half completed house, Giurgola debated whether to paint the timber cladding a light blue, or leave it naturally finished. He settled on the painted finish which expands the view by blending the soffit with the colours of the sky. Underfoot are burnt red terracotta tiles on a concrete slab, evoking Giurgola’s Italian origins.

Upon entering the house, the interior of the large room is vaulted up inside the pyramidal roof to a central square lantern which lights the space from above, as in the Trenton Bathhouse, balancing the light from the large picture windows overlooking the artificial plateau. However, unlike Kahn’s Bathhouse, two circular dormer windows, formed by cylinders, punch through the ceiling envelope at the angle of the

⁴⁶ Unverified claim by Philadelphia architect Stephen Lauf. Refer Quondam: A Virtual Museum of Architecture. <http://www.quondam.com/40/4081.htm>

opposing roof, and extend out beyond, giving the impression of a deeper volume. They provide two tracking lights that mark the passage of the day and the seasons, like the side lights of the Florence Cathedral dome, or Asplund's library. And yet, Giurgola's dormers defy the highly symmetrical building as they are offset from the centre axis, marking the oblique entry.

Internally there are no doors for access to the flanking servant spaces. Instead, floor to ceiling sliding screens are covered in richly coloured felts and conceal the private spaces beyond; consistent with the earlier designed Swedish house, perhaps an idea that was embedded there. Whereas the tenants of Le Corbusier's modernism demand the use of white, bland surfaces detaching the inhabitant from the landscape, Giurgola's choice of naturally finished materials externally, and internally, a simple palate of terracotta tiles for the floor, timber boarded ceiling, and coloured felts on the walls — similar to those of the Scandinavian tradition — seek to connect the inhabitant with the familiar and the comfortable. Giurgola and his daughter, art collectors and painters, later expressed some regret with the screens as there was no wall space in the grand room for hanging works of art.

Discussion

From its outward appearance Giurgola's house relates to the Western European tradition of the ideal villa, as characterized by Beck and Cooper. The house's pyramid roof set over a defined platform consolidates this impression. Although Giurgola's configuration of the plan geometry has its roots in the 1960s reappraisal of the Renaissance through Wittkower and Rowe, explored by Kahn and Venturi, the secondary moves to remove the servant spaces on the view side, and the smaller oddity of the dormer windows are not explained by these sources. Equally, although there are accords with the way in which Le Corbusier's house diagonally divides the cellular spaces from the open spaces, as in Rowe's analysis of the Villa Savoye, Giurgola's use of the diagonal does not appear related.

Pier Vittorio Aureli (2009) has observed that Palladio exaggerated the scale of elements such as porticos and by doing so subverted their usual role within an urban setting. Instead of being a grand entry, they are actually orientated outwards towards

the countryside. ‘In other words’, Aureli goes on, ‘the porticos act more like theatres for a spectacle that pre-dates the building: the landscape all around’. It was perhaps this odd juxtaposition of urban elements from his home city reprojected in the countryside that resonated in Giurgola’s mind in formulating the tension in his buildings, and that which also attracted the overlapping interest of Colin Rowe and Robert Venturi in the 1950s.⁴⁷ For Venturi, Aalto was the Palladio of his time.

Alvar Aalto’s admiration of the way in which Italians integrated buildings into the landscape is well documented (Quantrill, 1983). According to Eeva-Liisa Pelkonen (2009, p. 39), who has written on the geo-politics of Aalto’s architecture, Aalto was convinced that in order for Finland to foster a national identity distinct from its past as a fringe colony of either Sweden or Russia at the edge of the wilds, it needed to emphasise its links to the origins of Western culture. Aino and Alvar Aalto’s honeymoon to Italy in 1924 is suggested to be a result of Aalto’s generation then recent interest in Italian culture, drawn to Venice, Pompeii, and the small hill towns of the north. Aalto, and the others of his generation, were more attracted to the vernacular domestic buildings and streets of Italian towns, especially those of the Renaissance, than to the monumental cities. Pelkonen writes that Northern architects admired forms that resisted perfect geometries and compositional order: off-centre piazzas and facades that were almost, but not quite symmetrical.

In the early phases of Aalto’s career he experimented with Italian building types as represented by Aalto’s Casa Lauren (designed 1925, built 1927-8) and Funeral Chapel Project (unbuilt 1925). It was not until the Villa Mairea (1936), credited as being the transforming catalyst from his brief embrace of Functionalism (Radford & Oksala, 2006), that Aalto finds a synthesis between Modernism, the Finnish landscape and culture and the Western tradition that had attracted him early in his career. Aalto

⁴⁷ Denise Costanzo (2013) argues that despite association with opposing architectural camps (the ‘Whites’ and the ‘Grays’) in the 1950s Rowe and Venturi’s interests in early modern Italian architectural traditions overlapped, both consistently asserting the relevance of Mannerism to modern architecture.

designed an L shaped plan around an implied outside room (Quantrill, 1983), which is a pattern he repeated for his later experimental house at Muuratsalo (1952-53). The experimental house is set in the Finnish forest wilderness, overlooking Lake Päijänne to the south and west, perched on a granite outcrop. Its white painted walls and grand dimensions seem discordant with the site. Marc Treib comments that the house is ‘comforting in its seeming familiarity yet thwarting the visitor’s expectation’ (Treib, 1998) :58.

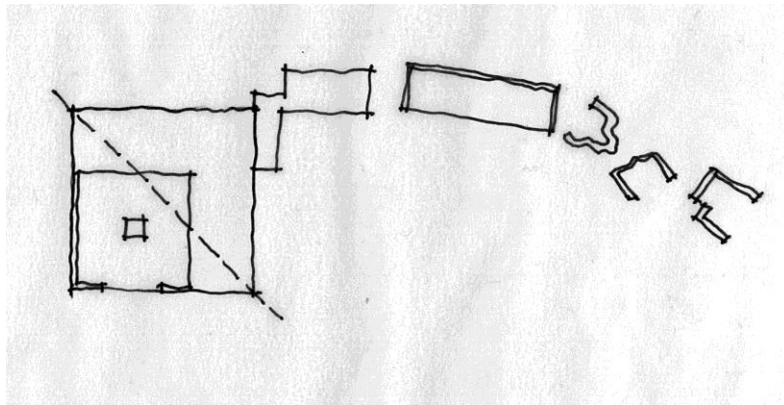

Figure 7.21 Plan of Aalto's Summer House at Muuratsalo overlaid with diagonal. Drawn by author.

An inverse reading of the two Aalto houses as ruined wholes perhaps provides an insight into Giurgola’s appreciation of Aalto, although they have very little direct stylistic association. The plans of Giurgola’s country house and Aalto’s main pavilion of his summer house are remarkably similar in the zoning of service spaces around atria. But where an atrium would expect to be encircled, Aalto and Giurgola remove two sides and allow it access to the view. Aalto’s is open above and walls fragmented to allow views to the lake beyond. Like Palladio’s Villa Rotunda, the urban elements re-composed in the Finnish woods give this house a sense of theatre and play, which is further emphasizes by Aalto’s experiments with red brick and glazed tiles that line the interior of the courtyard. Giurgola’s atrium on the other hand is calming and centralizing. Its symmetry and platform are what holds it to the landscape, yet like Aalto’s villa, its intention is to confound expectations. Aalto’s villa is suspended between the Finnish woodland and the Italian hill town while Giurgola’s is suspended between memories of his rambling around the Palladian villas and Kahn’s controlled essentialism. Between earth and sky, short view and long view, closed spaces and

open spaces, Giurgola's villa converses with the Australian landscape and simultaneously to the history of the villa type.

Giurgola's country house fits conceptually between the two previously discussed churches. There is purity of form closer to the St Patricks Cathedral not expressed in St Thomas Church and again there is not the same direct expression of 'decay' or the 'ordinary' in the design. However, the simplicity of architectural devices employed in the house design is more closely related to the St Thomas Church, particularly the narthex of the church with its pyramid roof, also used for the roofs of Parliament House chambers. In the St Thomas Church, the ruining of the cloister and odd addition of domestic scale elements sets the composition on edge, thwarting expectations. In the St Patrick's church, the tension is created by a stressed thinness. In Giurgola's Lake Bathurst house the tension is created formally by the diagonal and off centre elements in an otherwise symmetrical composition. In each case, these small foils are intended to confound and provoke, not in the radical postmodern way of say Ashton Raggott McDougall's National Museum, but to converse with their surroundings.

Postscript to the RG House: The villa as paradigm⁴⁸ and the architecture of the 1980s Australian country house

As James Ackerman (1986) has observed, the villa is one of the most radically ideological architectures because in claiming self-sufficiency within the countryside it hides its economic dependence on the city. Thus, to counter Rowe's disconnection of the villa with its historical context, Aureli (2009) argues that the Palladian villa cannot be divorced from its geo-political setting. Aureli's proposition is that Palladio was invested with a larger programme to reinvent Vicenza as a model for an Imperial Roman city – that is, Aureli posits, 'a new Italian civilization finally liberated from the Goths'. Palladio undertook a careful study of Roman architecture as the appropriate language for this political project. For Aureli, Palladio's careful

⁴⁸ Section title borrowed from James Ackerman (1986)

documentation of Roman antiquity during his visits to Rome, using a flat orthogonal method contributed to his systematic approach. 'Architecture was not visionary and picturesque but scientific, the product of carefully defined rules'. It is the use of these urban elements reprogrammed into landscape settings that makes Palladio's villas so affecting. Aureli describes a theatrical framing of the garden setting in which the surrounding territory is not a 'passive ground to be activated by the imposition of a figure, but a specific site made of existing natural and artificial elements of which the object – the villa – becomes a theatrical frame'.

The term 'villa' is rarely used in contemporary Australian architecture to refer to pleasure houses, perhaps because the term having its roots in the country estates of ancient Rome's upper class, has not been seen as a good fit for the image of a relaxed, class free Australia. Australians prefer to call their summer escapes shacks, beach houses or holiday houses. Despite the rarity of the term's use, second homes have been a feature of Euro-Australian history, and the sites of architectural experiment and contest, as they have been in other Western societies.

The 1980s Australia into which Giurgola arrived was a period in which the image of the Australian house was being transformed by a confluence of a greater concern with defining Australian cultural identity, community (Evans, 2005) and impact on and response to the natural environment. In architectural form marking, the period saw the introduction of post-modern concepts stemming from the United States through architects such as Peter Corrigan who had returned from studies under Robert Venturi. Architects Greg Burgess, Glenn Murcutt, Peter Corrigan and John Andrews (then recently returned to Australia) all had forays into the countryside in the 1980s in which they re-interpreted the villa in various forms. Their houses are experiments which interpret the flow of the post-modern to Australia, and offer vignettes of the Australian architectural culture of the 20 years of Giurgola's dwelling in Canberra.

Elegant bush and beach houses by Murcutt, Bruce Eeles, Ken Woolley and Peter Stronach (of Allen, Jack & Cottier) feature as examples of a 'Sydney School', following the notion penned in 1979 by Jennifer Taylor. Melbourne, on the other hand, according was the 'City of the Mind' (Spence 1986). Being much less topographically stimulating and less predictable climatically than Sydney, life in

Melbourne revolves around cultural institutions and life as distinct from the bush. Amongst other larger work, the houses of Peter Corrigan, Greg Burgess and Suzanne Dance were feature as the proponents of a 'Melbourne School'.

Peter Corrigan's Calnin House (1986) at Korumburra was a fragmented set of colliding linked pavilions that appeared intentionally discordant. Corrigan described his country houses as projecting 'anger' towards 'middle class, conservationist revisionism' of the Australian bush. He believed that architecture should be concerned with the suburban scene being the place where most Australians live (Corrigan, quoted in Spence 1986). Like his teacher Venturi, Corrigan was looking to provide a simultaneous critique of the suburbs and of architect's architecture.

The houses of Greg Burgess in the same period were likened to an 'evocation of several patterns from Christopher Alexander's *Pattern Language*. Burgess's house at Traralgon, Victoria, 1986 is a complex assembly of contradictory geometries which are reminiscent of Venturi's Vanna Venturi House. An axial entry path concludes at an awkward junction of a splayed plan and a central stair which ascends into an elevated pavilion, giving the appearance of a tree house, or light house, supported by a meandering root base. Spence (1986) comments that the unusual geometry in the house was a common theme in Burgess's buildings. The normally symmetrical and static geometries are eroded or contradicted by other geometries.

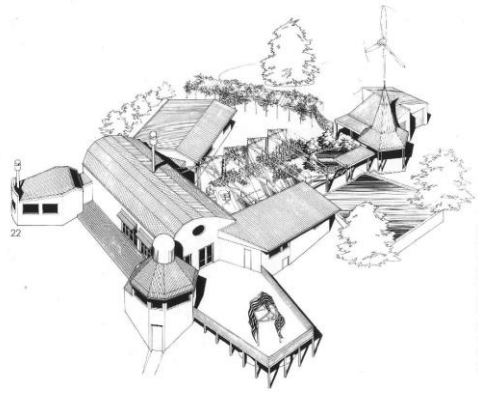

Figure 7.22: Peter Corrigan's Calnin House, 1986, at Korumburra

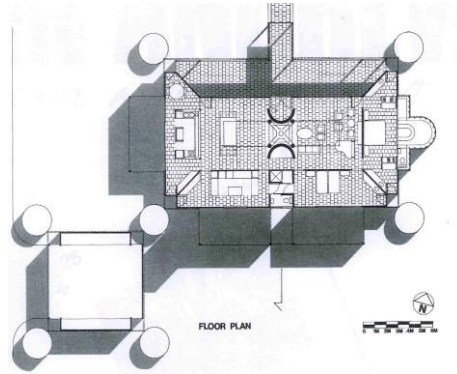

Figure 7.23: Eugowra House, John Andrews, 1983



Figure 7.24: Burgess's house at Traralgon, Victoria, 1986

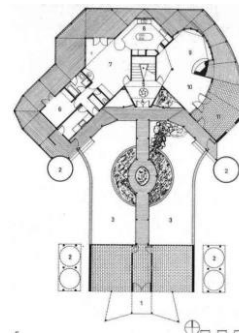

Figure 7.25: Ground floor plan of Burgess's house at Traralgon, Victoria, 1986.



Figure 7.26 Fredericks-White House, Glenn Murcutt (1981-82). 'Thinking Drawing / Working Drawing' published by TOTO, Japan, 2008. Photograph by Anthony Browell

Ultimately the accessibility of Murcutt's architecture, particularly the use of the verandah-as-building metaphor and his selection of steel and corrugated iron hit a resonance with an image of Australian national identity (Cooper, Murcutt, & Beck,

2002). Built for the White family on the other side of the Great Dividing Range, about 160km from the RG House, the Fredericks-White House (1981-82) is an example of Murcutt's taut, finely detailed linear forms that have become so recognisable. Murcutt on the other hand describes himself as a pragmatist and rationalist, tending to shun descriptions of his work associated with narratives of national identity. The use of steel, Murcutt has been quoted to prefer for reasons of economy, utility, 'and because few carpenters are sufficiently skilled to guarantee the precision that he requires' (Cooper et al., 2002). Murcutt's obsession with construction detail and fine tuning (Gusheh & Lassen, 2008) that once led to Alison Smithson to describe him as a 'timber and tin Miesian' holds his villas in a tight relationship with the landscape. They communicate a tent-like occupation of the land, which in turn idealises it.

At the more detailed level at which Murcutt is focused, the exterior skin of his houses is modulated according to the climatic and site conditions, typically conceived as a series of operable layers (Gusheh & Lassen, 2008). Spaces within the houses are typically tightly programmed around a linear circulation spine. Use of overhead light has a functional derivation to provide light to workspaces, as in the Magney House (1982-84), or natural light to the centre of a double loaded spine, as in the Kangaloon House (1997-2001). These highly tuned machines are designed to respond to their climatic context.

Meanwhile, the recently returned John Andrews, who was instrumental in selecting Giurgola's competition entry for Parliament House, built a house at Eugowra (1983) for his family. Designed in 1977, the house was derived from an earlier design for a family house in Palm Beach (J. Taylor, 1982). Jennifer Taylor comments that 'the lessons learnt' from Andrews's experience of living in the existing farmhouse on the property, a high pitched roofed cottage wrapped on all sides by a low slung veranda, contributed to the more squat version of the earlier two storey Palm Beach house to, '...a traditional Australian homestead, close to the earth, and sheltered by its simple, sloping roof'. Andrew's house is geometrically laid out around a central space, wrapped on three sides by service rooms, and features diagonal walls that define its corners. Giurgola's house plan is strongly related to Andrew's in the organisation of

service spaces around central living areas, and the use of diagonals in the corners. However, the layout of Andrew's rooms is symmetrical.

Giurgola's picture of the landscape around Canberra appears somewhat different to that of Murcutt's. Giurgola's villa describes a bounded world and can be read as a criticism of the building-as-verandah on a number of levels, although it incorporates some elements - the choice of corrugated steel, for instance. Seated firmly on its gently carved out platform, RG House has a multi-directional relationship with its surrounding landscape. Moving in and around the house, the view is ever changing from short view from the servant spaces looking back at the wooded hillside to the open view foregrounded by the raised grassed. Like the Andrews's Eugowra House, by separating off the service spaces, Giurgola achieves a differentiation of space heights not usually available in the extruded forms of Murcutt. Instead, the 'grand rooms' of the RG House and the Eugowra House allow a looser arrangement. Giurgola, as in Andrews's house, converts the wrapping verandah, derived from the vernacular Australian farmhouse, to flanking terraces.

The pyramidal roof of the RG House with lantern over and sky tubes is where Eugowra and the RG House depart. John Andrews's 'energy tower' (Andrews & Taylor, 1982) is a centrepiece of the composition. At the base of the tower is a massive fire hearth that is at the cross axis of the plan. Overhead the tower is capped with a galvanised iron rainwater tank, recalling railway siding water tanks. Andrews elevates the mundane and practical to the celebrated in a different way to the radical postmodernism of Corrigan. Corrigan's scheme for the Calnin House included a quirky windmill, but it was not incorporated as a fundamental element of the composition as it was in Andrews house. Andrews's dwelling on the site at the pre-existing farmhouse is said to have provided him a deeper insight into the practical needs of the busy (Taylor 1982). The energy tower in an earlier scheme for the farmhouse (1977) was a stand-alone structure outside the house, but by in the final scheme (1979) it was moved to the centre so that, along with its diagonal corner walls and symmetrical approach, it could well be read as a diagram of Giurgola's Parliament House in which Andrews was in the midst of assessing. In the later RG House Giurgola's grand room, there is an absence of that grandness expressed

through physical forms. Heating for the place is a simple stove and furniture defines areas for different activities within the room.

Irrespective of whether the Melbourne/Sydney characterisation is a useful hypothesis, it is apparent that the 1980s there were a number of competing ideas fermenting across Australia that used the bush villa paradigm as a rite of passage. Murcutt's houses have become a popular image of the designed Australian house. Giurgola's house offers an interpretation that challenges Murcutt's notion of touching the earth lightly. Murcutt's houses sits politely above the ground plane while Giurgola's house takes confident possession of the landscape. Where Murcutt's villas convey an image of unoccupied land that feeds into the Australian cultural identity of bush dweller (Australians are city dwellers), Giurgola's house ventures that the land is tamed, and like the houses of Palladio he visited in his youth, gathers up the bucolic scene laid out below. In doing so, Giurgola is inclusive of the significance and power of the transformation of the Australian landscape through European settlement.

Chapter 8 Conclusions

Romaldo Giurgola's place in Australian architecture was cemented with the opening of Parliament House in 1988, the largest public project that had been undertaken in Australia at the time. Giurgola made a significant contribution to Australian architecture and culture through the parliament building, but his further contribution through the work of his later career has largely been overlooked. Before arriving in Australia, Giurgola was a recognised architect in the United States, known for his association with Louis Kahn and later the 'Greys' in the Grey/White discussion of the 1970s. However, in his Australian work there is less observable focus on the 'signs' that characterise the later work of this group. Instead, the buildings appear to have an antecedent in Scandinavian modernism not anticipated in Giurgola's trajectory.

This thesis has set out to undertake an analysis and interpretation of Giurgola's Australian work that seeks to gain a more complete understanding of this influence and why Giurgola's mind image of Australia and his personal journey shaped his architecture more in the practical tradition of modern architecture that is often associated with Northern Europe. Other Australian architects who rose to prominence in the 1980s were also attracted to the Nordic tradition of modernism. Glenn Murcutt, for example, acknowledges that his modernism has its roots in the work of Aalto. Accordingly, situating Giurgola's architecture in the Australian context aids in understanding more about the shifts in architectural culture in Australia during and following the building of Parliament House and why Australian architects have been fascinated with Nordic modernism.

The parliament building received international attention at a number of levels. In critical architectural and social reviews, opinion was split over the value of the place. Some praised the building for being a good fit with the Canberra plan, reinforcing the Griffin/Mahoney vision for an Australian Capitol. Others, conversely, found that the Giurgola scheme, although well suited to the Griffin/Mahoney geometry, was all a bit bland, diagrammatic, and polite; failing to really hold up any ideal for Australians to aspire to. Much of the latter criticism was heavily coloured by the image of Giurgola

portrayed in discussions on the merits of the post-modern that occurred on the East Coast of the United States.

And yet, a more complex picture is painted by constructing Giurgola's personal journey and encounter with Australia through a closer look at the buildings that follow the Parliament House. The analysis of his Australian buildings has revealed consistent patterns in his work that question a close association with the post-modernist double coding themes of in their origins of the late 1970s to early 1980s. Giurgola's dissatisfaction with post-modern pastiche led him look elsewhere. This is not well understood. The commissions Mitchell/Giurgola acquired from Volvo's entry into the United States in 1973 sponsored Giurgola's encounter with Sweden. The Volvo projects and his rapport with Volvo CEO Pehr Gyllenhammar who had introduced the group assembly system in car manufacture were transformative influences on Giurgola. The values expressed through the group assembly in manufacturing were a good fit with Giurgola's image of team work in architectural production and his values of fairness and the social responsibility to promote good citizenry through design. The Swedish commissions, particularly the Volvo Headquarters building which ran concurrently with the Australian Parliament House, gave Giurgola further opportunity to visit Sweden and interact with Swedish pragmatism, their craft and art. His relationship with the Danish artist Lin Utzon in the crafting of the surfaces of the Volvo building was one such collaboration that influenced the way in which Giurgola thought about the interaction between art and architecture. It subsequently informed his methods in fitting out the Australian Parliament House using locally sourced artists and artisans.

Events outside his professional life also had an influence on his transformation. The year 1989 was decisive in Giurgola's life journey. It marked the end of the construction of Parliament House and a time in which his wife's needs began to feature strongly. From 1987, with Adelaide ill with Alzheimer's and it being increasing difficulty to navigate the busy-ness of large cities, they contemplate a permanent move to Canberra. The ongoing management of his wife's condition until her death in 1997 in Canberra had a considerable effect on Giurgola. Although he

does not describe himself as a religious man, religious themes from his childhood began to feature in his work.

Professionally, Giurgola also endures a setback in the United States with his controversial proposal to extend Kahn's Kimbell Museum with concrete vaults matching those of the distinctive Kahn design. Despite Giurgola's defence that it was a dutiful reflection of Kahn's early sketches of a larger museum, many of Giurgola's peers were scathing in their criticism of the eventually quashed scheme. Thus, in the afterglow of the recently completed Parliament House, Giurgola must have sensed a warm, welcoming embrace in Australia, far from the pressing anxieties and complexities of a New York life. Censures of the parliament building did not blunt Giurgola's enthusiasm for Australia. Unencumbered by the direction of a large international architectural office, and teaching life, Giurgola became a recent, but mature, immigrant. His retirement from MGT Architects released him from further complications, and in this newly acquired freedom, Giurgola had the opportunity to re-fit and re-invent.

Giurgola's then recent immersion in Swedish art culture is strongly evident in the design for the St Thomas Church in Charnwood, the first Australian project after Parliament House. The small church is the most obviously Scandinavian of the Australian projects and is full of reminiscences of Giurgola's visits from Italy to the North dating back to his formative years during his training in Rome. The references to Alvar Aalto's Maison Carre and Jørn Utzon's Bagsværd Church are clearly recognizable in early sketches and the forms and motifs of these buildings are translated through the design development of St Thomas. The church's ruinous qualities are reminiscent of those themes observed in Aalto buildings, but it also contains the stressed cardboard-thin walls and odd domestic incursions. The Scandinavian influence mark it out as distinct from more direct interpretations of Venturisms that arrived in Australia through architects returning from studies in the United States in the 1970s. The Melbourne Four's contemplations on an Australian architectural language imagined a binding of suburban clichés and high-brow architecture through literal references to pop culture and 'purposeful awkwardness'.

Giurgola's second religious building, St Patrick's Cathedral, Parramatta, is located amongst the real issues of the Australian Ugliness. The symmetrical glass and concrete box appearance of St Patrick's is ostensibly a return to classical forms – symmetrical, controlled and 'polite'; however, the treatment of the existing site elements and the interior space of the cathedral invites other interpretations. The elaborate neo-gothic detailing and tower of the existing ruined building always going to be a dominant visual element. Instead of emphasising the difference, Giurgola sought to incorporate the ruin into a cohesive whole. Giurgola contrived tensions within the composition of the new addition so that its parts create an unsettling sense of the unexpected, the unfinished. The tension is not, however, the exploded disarray promoted by Peter Eisenman and Zaha Hadid in the deconstructivist movement that was so influential in the 1990s. Instead, it is a tightly held arrangement to simulate the sharpness of crossing the threshold from the profane to the sacred.

Giurgola's house for himself at Lake Bathurst was his final building project, but more than the others, it is demonstrative of Giurgola's understated contribution. It is a distillation of the ideal house that has travelled alongside him in his life journey since he encountered the Palladian villas in the early years of his training, further reinforced upon his arrival in America and discussions with Louis Kahn. When seen in context with the alternate interpretations of those ideas stemming from Venturi and Christopher Alexander in the United States through the Four Melbourne Architects, and others, the simple house attests to Giurgola's rejection of the grand themes that he encountered in their Italian and American origins.

The patterns that emerge from the four buildings studied in this thesis tie Giurgola to modernism as a practical art. There are consistent themes of ruination, incompleteness and local contextualism that relate Giurgola's Australian architecture with an 'other' modern tradition offered by Colin St John Wilson, who describes a careful consideration of practical values as the guiding principle rather than the implementation of abstract theories. In the case of the Canberra church, it is the elements that Giurgola gathered up from suburbia that append the building to the suburb. The Parramatta cathedral is responsive to the constituent parts of the site and the broader context (the existing cathedral, presbytery, Marist house, adjoining park,

and the city), so that it reinforces the physical values of the ruined Neo-Gothic, but at the same time interprets the complex cultural tensions. It bridges between the housing of historic religious rituals and the largely secular world in which it sits. Similarly, at the house at Lake Bathurst, Giurgola gathered up the physical and cultural context and fused it with his mind image of the ideal villa. In this manner Giurgola set the Australian farmhouse in the greater cultural and historical context of the ‘hut in paradise’, in parallel with the extension of the embodied man who is at home in his/her environment, not in awe or fear of it as the all-powerful ‘Nature’ of the Romantic imagination represented in the Palladian villa.

Looking back through the lens of Giurgola’s later work in Australia, the parliament building takes on other shades. Many of the themes of his later buildings following Parliament House are evident in their early stages in the parliament building: the great veranda, the odd terracotta roofs over the houses, the low, ground hugging layout, and the rolling suburban grass that refer to the Canberra context. A post-modern view of these elements, including the enormous flagpole, would see them tinged with exploded forms of the ordinary. And yet, Giurgola was in search of that ‘something else’ that could bind the building to the place, in its physical and cultural context. Parliament House, considering its size alone, was an unwieldy proposition. The tensions achieved with the later three buildings considered in this study are not as apparent in the parliament building, and perhaps because of the size, tight brief and ‘fast track’ construction method – as commented on by others – they missed their mark. Nevertheless, there are the seeds of motifs that Giurgola developed in the later Australian projects.

The reflections of ethicist and philosopher Warwick Fox (touched on briefly earlier) concerning ethical values in making interventions into existing systems have potential significance for the way in which we understand Giurgola and the values observed in St John Wilson’s work. Fox’s concept of responsive cohesion, when considering the parliament building, for instance, is a question not only whether or not its design can be described as a suitable response to its immediate context, but also of whether or not the supporting context itself also benefits and is transformed.

In Giurgola's smaller St Thomas Church, the conversational aspects of its composition relate it to the open landscape in which it sits, and along its secondary axis, through the use of domestic scale elements, it is related to the adjacent suburb. Within the composition itself, the inclusion of the existing priest's residence demonstrates Giurgola's sensitivity to existing support systems, economic and, in the case of the parish priest, emotive. Giurgola recognised that the modest house has little redeeming architectural value. And still, despite its deficiencies, he closely integrated it into the composition; thereby affectively raising its architectural value. Elements of the new building, too, reflect back on the ordinary materiality and form of the existing dwelling, simultaneously anchoring the otherwise alien white figure of the new building to the place with house's inclusion in the composition. Within the larger context of the suburb, a similar effect can be observed. By balancing being quite different from the suburb in its form and materiality from the suburb and being not quite so different as to create a complete contrast, the building can be read as both a re-statement of the suburb and as a masterful, rational, composition of architectural references.

St Patricks Cathedral similarly has a responsive, conversational relationship with the pre-existing Neo-Gothic church and surrounds. Although it is the larger and more important ceremonial space, the new cathedral sits in deference to the vertical scale and detail of its neighbour. Instead of making it the dominant figure, as in the St Thomas Church, Giurgola reversed their roles and reinforces the Neo-Gothic church and its spire in what he interprets as the salient features in the historical order of Parramatta. The plainness of the cathedral's exterior form and materials are an antidote to the noise (discohesion) of Parramatta suburbia; and its low, squat outline is the ground from which the Neo-Gothic spire is expressed. In doing so, the parts of the composition are held in dialogue with each other; one part dependent on the other. At the same time, as a whole, they look outward to the order of the city, gathered up in Giurgola's mind from its historic underlay. In this light the St Patrick's Cathedral, Parliament House and St Thomas Church have a common thread that is not discernible at first glance.

At the RG House, Lake Bathurst, Giurgola's embrace of the Palladian/Kahnian villa as well as the historical form of the Australian farmhouse sets the building both in the cultural and historical (intangible) context as well as its physical (tangible) context. In the larger physical context, its human scale provides a point of reference from which to read the expansive and flat Australian landscape. At the closer level, moving around and within the house, its configuration and openings provide a multiplicity of interactions: between earth and sky, between short view and long view, between closed spaces and open spaces, so that the conversation with its surrounding context is ever shifting. Recent work by Huang and Radford (2014), looking at the 1980s houses of Troppo Architects in Northern Australia as an example of responsive cohesion, has begun to talk about intangible contexts alongside responses to the physical contexts. Form derived from Pacific Islander huts and adapted to respond to the modern Australian lifestyle is the distinctive feature in their reformulation of the villa. Despite their obvious formal dissimilarity, Giurgola's and Troppo's consideration of the salient features of a cultural and historical context brings them into closer alignment. Huang and Radford argue that it is the Australian informality of Troppo Architects, combined with their more serious and practical concern with climatic response, that has made their architecture distinct from other architects of the time. At the Lake Bathurst house, the conversation is across the history of the Western villa as a type, and its reformulation particular to the place in which it sits. Conceivably it could also be argued that Giurgola put on some of the casual Australian attire. Perhaps responsive cohesion is a better way of expressing Giurgola's notion of the 'partial vision' that he elucidated in 1965. Further thought could be given to Giurgola's greater body of work as an example of responsive cohesion. In particular, his Italian work of the early 1980s, with its overtly vernacular references that seem at odds with other work of the same period in the United States could provide useful material for investigating Fox's concept.

Giurgola's Australian work shows how he has tackled the real issues specific to a site – its many and varying contexts – eschewing a vision of architecture as an authority for social change, but without retreating from an active engagement with collective aspiration. Giurgola's Australian work illustrates how a number of nested contexts, including those beyond the physical, can be considered simultaneously, something

that is often missing from the way in which recent architecture has developed to fit the single image. His vision was shaped by Kahn and the discussions with Venturi, but it was the cultural exchange with Scandinavia facilitated by the Volvo project and his fascination with the achievements of Alvar Aalto that allowed him to find a mid-point between the essentialism of Kahn and the more radical postmodern. This conscious middle road in his architecture and politics contributes to Australian's vision of their governance through the architecture of the parliament building. In Giurgola's words, speaking of his memory of Aalto's visit to Italy,

He [Aalto] was very human. He was telling everyone how to get drunk, how to get up to mischief and at the same time talking about architecture. It was really a refreshing thing compared to when you have this dogmatic Corbu showing up...I never lost that — even when I later met Louis Kahn, for no matter how much Louis Kahn appealed to me in terms of understanding again the Classical in architecture, revisited in a different way, Lou was too prophetic, almost Oriental, the way he was talking and doing buildings, and I didn't take that side. For how much I look at his work, I always like to have a more human aspect to it (Giurgola 2007a).

References

- . (1977). Condon Hall, School of Law/Law Library, Seattle, Washington. *Architectural Record*(8), 96-98.
- Ackerman, J. (1986). The Villa as Paradigm. *Perspecta*, 22, 10-31. doi: 10.2307/1567090
- Alexander, C. (1975). *The Oregon experiment*. New York: Oxford University Press.
- Alexander, C. (1979). *The timeless way of building*. New York: Oxford University Press.
- Alexander, C., Ishikawa, S., & Silverstein, M. (1977). *A pattern language : towns, buildings, construction*. New York: Oxford University Press.
- Allaback, S. (2000). *Mission 66 visitor centers : the history of a building type*
Retrieved from
http://www.cr.nps.gov/history/online_books/allaback/index.htm
- Anderson, B. (2011). Alvar Aalto and Jørn Utzon - An Architecture of Ancient Gathering Forms *UME*, 22, 44-59.
- Andrews, J., & Taylor, J. (1982). *Architecture : a performing art*. Guildford: Lutterworth.
- Arvanitakis, J. (2013). Julia Gillard's western Sydney road show: the good, the bad and the ugly. *The Conversation*. Retrieved 20 June, 2013, from
<http://theconversation.com/julia-gillards-western-sydney-road-show-the-good-the-bad-and-the-ugly-12605>
- Authority, A. P. H. C. (1985). *Australia's new Parliament House*. Canberra, ACT: Parliament House Construction Authority.
- Baker, G. H. (1989). *Design Strategies in Architecture: an approach to the analysis of form*. (2nd ed.): Van Nostrand Reinhold Company.
- Beck, H., & Cooper, J. (2004). R G House. *UME*, 17, 2-11.
- Beck, H., & Cooper, J. (2005). St Patrick's Cathedral. *UME*, 19, 26-33.
- Beck, H., & Mitchell / Giurgola & Thorp Architects. (1988). *Parliament House, Canberra : a building for the nation*. Sydney: Collins.
- Beier, B. R. (2006). *Preserving the work of Mitchell/Giurgola Associates*. (Thesis (M S in Historic Preservation)), University of Pennsylvania.
- Bell, D. (1979). Unity and Aesthetics of Incompletion in Architecture. *Architectural design : A.D*, Jan. 1971-(7), 175-182.
- Berg, P. (2000). *Romaldo Giurgola's incorporation of art within his architectural projects: an overview of twenty two years of collaboration*. Paper presented at the Romaldo Giurgola Symposium, University of New South Wales, Sydney.
- Berg, P. (2007). *Recollections of Mitchell Giurgola Architects: Pamille Berg, Partner*. In S. Schrapel (Ed.). unpublished.
- Bourdieu, P. (1990). *The logic of practice*. Stanford, Calif.: Stanford University Press.
- Brennan, A. (2007). Book Review: Warwick Fox, A Theory of General Ethics: Human Relationships, Nature, and the Built Environment. *Notre Dame Philosophical Reviews*.
- Brewer, J., & Hunter, A. (1989). *Multimethod research : a synthesis of styles*. Newbury Park, Calif.: Sage Publications.
- Brooks, D. (2007). *Recollections of the Canberra office of MGT Architects: Douglas Brooks, Associate*. In S. Schrapel (Ed.). unpublished.

- Brown, D. S. (1967). Team 10, Perspecta 10, and The Present State of Architectural Theory. *Journal of the American Institute of Planners*, 33(1), 42-50. doi: 10.1080/01944366708977994
- Brown, J. H. (2008). *Responsive Cohesion and the Value of Wild Nature*. Paper presented at the Canadian Society for Aesthetics.
- Canella, G. (1996). That 'third generation' of Geidion. *Zodiac*, 16, 4-21.
- Chang, C.-Y., & Architects, M. G. A. (1977). *Mitchell/Giurgola Architects*. Tokyo and Forest Grove, Or.: Process Architecture Publishing Co. .
- Collins, P. (1963). Runner-Up in the Boston City Hall competition. *Progressive Architecture*, 145-153.
- Cooper, J., Murcutt, G., & Beck, H. (2002). *Glenn Murcutt : a singular architectural practice*. Mulgrave, Victoria: Images Publishing Group.
- Cooperman, E. T. (2006). Romaldo Giurgola. *American Architects and Buildings Project*.
http://www.americanbuildings.org/pab/app/ar_display.cfm/110256?&Printable=1
- Corrigan, P. (1988). The Argument from Design + Mitchell Giurgola and Thorp Parliament House. *Architectural Review*, 184(1100), 61-61.
- Cox, P. (1988). Focus on the Flag: Mitchell/Giurgola and Thorp Parliament House. *Architectural Review*, 184(1100), 62-62.
- Crosbie, M. J. (2011). *New York dozen : gen X architects*. Mulgrave, Vic.: Images Publishing.
- Davies, B. (2007). 'Lessons from our past' vital to our future: A CONVERSATION with Fr JOHN BOYLE. *The Catholic Weekly*.
- Dixon, J. M. (1988). The Australian Scene: The Parliament House by Mitchell/Giurgola and Thorp. *Progressive Architecture*, 69(8), 9-9.
- Dobrez, L. (1999). 'Late' and 'Post' Nationalisms: Reappropriation and Problematization in Recent Australian Cultural Discourse. In A. Wimmer (Ed.), *Australian nationalism reconsidered : maintaining a monocultural tradition in a multicultural society* (pp. 6). Tübingen: Stauffenburg Verlag.
- Dovey, K. (1990). The Pattern Language and its enemies. *Design Studies*, 11(1), 3-9.
- Drew, P. (1994). *The Coast Dwellers: Australians living on the edge*. Ringwood, Victoria: Penguin.
- Drinkwater, F. (2002). Interview with Father Drinkwater, Priest of St. Thomas Aquinas Parish, Charnwood, Canberra. In S. Schrapel (Ed.). Canberra.
- Duany, A. (1986). Principles in the Architecture of Alvar Aalto. *Harvard Architecture Review*, 5, 105-119.
- Edquist, H. (1988). The Spiritual in Architecture: Greg Burgess's Church of St Michael and St John, Horsham. *Transition*(Autumn), 59-65.
- Eisenman, P., & Alexander, C. (1982). Constrasting Concepts of Harmony in Architecture. *Lotus International*, 40, 60-68.
- Eisenman, P., & Harrison, A. L. (2008). *Ten canonical buildings 1950-2000*. New York: Rizzoli : Distributed to the U.S. trade by Random House.
- Eliade, M. (1959). *The sacred and the profane : the nature of religion / by Mircea Eliade ; translated from the French by Willard R. Trask*. New York: New York : Harcourt Brace Jovanovich.
- Evans, D. (2005). The Changing of the Guard: the social and cultural reflections of Community in 1970s Melbourne architecture. *Fabrications*, 15(1), 39-53.

- Evolving Environment. (1960). *Interiors*, 120, 184.
- Farrelly, E. (2002). A prayer at the altar of permanency. *Sydney Morning Herald*. Retrieved from <http://www.smh.com.au/articles/2002/10/28/1035683357112.html>
- Favaro, P., & Manasseh, C. (2011). A Total Experience: The Constructed Environment of Romaldo Giurgola's "Casa di Campagna" in Australia. *The International Journal of the Constructed Environment*, 1(3), 127-140.
- Fox, W. (2006). *A theory of general ethics : human relationships, nature, and the built environment*. Cambridge, Mass. ; London: MIT.
- Frampton, K. (1983). Foreword *Mitchell/Giurgola Architects* (pp. 8-10). New York: Rizzoli.
- Frampton, K. (1995). *Studies in tectonic culture : the poetics of construction in nineteenth and twentieth century architecture / Kenneth Frampton ; edited by John Cava*. Cambridge, Mass.: Cambridge, Mass. : MIT Press.
- Francis-Jones, Morehen, & Thorp. (2014). Francis-Jones/Morehen/Thorp (FJMT) - Architecture, Interiors, Landscape, Urban Design. from http://www.fjmt.com.au/projects/projects_red.html
- Frankl, P. (1968). *Principles of architectural history; the four phases of architectural style, 1420-1900*. Cambridge, Mass.: MIT Press.
- Franzen, U. (1977). Mitchell/Giurgola Architects. In C.-Y. Chang (Ed.), *Process, architecture* (pp. 268 p.). Tokyo: Process Architecture Publishing Co.
- Frith, S. (2010). *Past and Present Exchanges in the work of Romaldo Giurgola*. Paper presented at the Interspaces: Art and Architectural Exchanges from East to West, Melbourne.
- Fung, S. (1985). *The Sydney School?* Paper presented at the *Conference of Architectural Historians, 15-16 June, Sydney*.
- Giurgola, R. (1961). As quoted by Jan Rowen in *Wanting to Be: The Philadelphia School*. *Progressive Architecture*, 131-155.
- Giurgola, R. (1962). Architecture in Change. *Journal of Architectural Education (1947-1974)*, 17(2), 104-106.
- Giurgola, R. (1964). Early Stages in an Idea in Architecture. *Dimension*, 15(Spring), 16-25.
- Giurgola, R. (1965). Reflections on Building and the City: The Realism of the Partial Vision. *Perspecta*, 9, 10.
- Giurgola, R. (1967). Romaldo Giurgola on Louis Kahn. *Zodiac*, 17, 119.
- Giurgola, R. (1969). A Propos de Louis Kahn. *L'Architecture D'Aujourd'hui*(142), 4-5.
- Giurgola, R. (1973). The Discreet Charm of the Borgeoisie. *Architectural Forum*, 46-57.
- Giurgola, R. (1975). Architecture is both image and reality. *S D; space design*(December), 2-3.
- Giurgola, R. (1977a). Design and Planning: Alvar Aalto. *Progressive Architecture*, 53-57.
- Giurgola, R. (1977b). The Impetus to Build. *The Christian Science Monitor*(August 21), 24-25.
- Giurgola, R. (1980). Notes on Architecture and Morality. *Precis*., 2, 51-.
- Giurgola, R. (1981a). An Open Letter to Students and Colleagues. *JAE*, 35(1), 13-17.
- Giurgola, R. (1981b). The Producing Moment. *Inland Architect*, 25(1), 38-42.

- Giurgola, R. (1982a). Giurgola on Kahn. *AIA Journal*, 71(9), 26-35.
- Giurgola, R. (1982b). *Walter Burley Griffin Memorial Lecture: A place for everything and everything in its place*. Canberra.
- Giurgola, R. (1986). *The fourth Ian McLennan Oration*. University of Melbourne.
- Giurgola, R. (1987). *Acceptance Speech: Thomas Jefferson Medal in Architecture*. University of Virginia.
- Giurgola, R. (1988). Parliament House, Canberra. *Architecture Australia*, 77-87.
- Giurgola, R. (1989). Recorded interview with Romaldo Girurgola. In M. Clark (Ed.). Canberra: National Library of Australia.
- Giurgola, R. (1992). *Architecture and Nature*. Paper presented at the National Landscape Architecture Students Conference.
- Giurgola, R. (2002a). *Canberra's Evolution: from an Artificial to a Natural City*. Canberra.
- Giurgola, R. (2002b). *Canberra as an international city?* Paper presented at the The Canberra Business Council lunch series, Canberra.
- Giurgola, R. (2002c). On Aalto's influence: Part 1. In S. Schrapel (Ed.). Canberra.
- Giurgola, R. (2002d). On Aalto's influence: Part 2. In S. Schrapel (Ed.). Canberra.
- Giurgola, R. (2002e). On Aalto's influence: Part 3. In S. Schrapel (Ed.). Canberra.
- Giurgola, R. (2005). *A Plan for a Region*. Canberra.
- Giurgola, R. (2007a). On a life in architecture: Part 1. In S. Schrapel (Ed.). Canberra.
- Giurgola, R. (2007b). On a life in architecture: Part 2. In S. Schrapel (Ed.). Canberra.
- Giurgola, R., & Berg, P. (2006). *Luminous simplicity : the architecture and art of St. Patrick's Cathedral, Parramatta*. South Yarra, Vic.: MacMillan Art Publishing.
- Giurgola, R., & Mehta, J. (1975). *Louis I. Kahn*. Tokyo: A.D.A. Edita.
- Glanville, R. (1978). Alvar Aalto: Detail and Totality, a Style of Completeness. *Architectural Association Quarterly*, 10(3), 18-29.
- Goad, P. (1988a). Faust veneered: The Australian Parliament House: a tour-de force in veneer. *Artcoast*, 1(2).
- Goad, P. (1988b). Reassessing the Democratic Ideal. *Architectural Record*, 176(8), 49-&.
- Goldberger, P. (1996, February 11). A Little Book That Led Five Men to Fame. *New York Times*.
- Goldhagen, S. W., & Kahn, L. I. (2001). *Louis Kahn's situated modernism*. New Haven, CT: Yale University Press.
- Graf, D. (1986a). Diagrams. *Perspecta*, 22, 42-71.
- Graf, D. (1986b). Diagrams. *Perspecta* 22, *The Yale Architectural Journal*.
- Griffiths, G. (1997). Polemical Aalto: the Enzo-Gutzeit Headquarters (1959-1962) by Alvar Aalto- A formal analysis. *Datutop*, 19.
- Groat, L. N., & Wang, D. (2002). *Architectural research methods*. New York: J. Wiley.
- Guida, Moseley, & Brown. (2014). Projects. Retrieved 26 February 2014, from <http://www.gmbarchitects.com/projects/>
- Guida, H. (2007). Recollections of Mitchell Giurgola Architects. In S. Schrapel (Ed.). unpublished.
- Guida, H. (2014, September). [Letter to author].
- Giurgola, R. (1977). Design and Planning: Alvar Aalto. *Progressive Architecture*, 53-57.

- Giurgola, R. (1986, July 25). [Letter to Pamille Berg].
- Gusheh, M. (2000). *Architectural Culture in the Fifties: a reading of Romaldo Giurgola with reference to Louis Kahn*. Paper presented at the Romaldo Giurgola Symposium, University of New South Wales, Sydney.
- Gusheh, M., & Lassen, C. (2008). Essay: Thinking drawing/Working drawing *Thinking drawing/Working drawing*. Japan: TOTO Shuppan.
- Gyllenhammar, P. G. (2011). Recollections of Romaldo Giurgola. In S. Schrapel (Ed.). unpublished.
- Hamann, C. (2000). *Resolving the partial vision: aspects of Mitchell Giurgola's American work, 1960s-1980s*. Paper presented at the Romaldo Giurgola Symposium, University of New South Wales, Sydney.
- Hartoonian, G. (2000). *Romaldo Giurgola's White/Gray Departures*. Paper presented at the Romaldo Giurgola Symposium, University of New South Wales, Sydney.
- Hawkes, D. (1996). The technical imagination: thoughts on the relation of technique and design in architecture. *The Journal of Architecture*, 1(4), 335-346.
- Herbert, J. D. (1999). Bad Faith at Coventry: Spence's Cathedral and Britten's "War Requiem". 25(3), 535-565.
- Heyer. (1977). Mitchell/Giurgola Architects. In C.-Y. Chang (Ed.), *Process, architecture* (pp. 268 p.). Tokyo: Process Architecture Publishing Co. .
- Hutson, A. (2008, 22 August). *The planning processes and why the design brief won*. Paper presented at the Architecture and Parliament: How do buildings shape parliamentary business?, Parliament House, Canberra.
- Hutson, A. (2011). "Square Peg in a Square Hole: Australia's Parliament House. *Papers on Parliament*, (55).
http://www.apf.gov.au/About_Parliament/Senate/Research_and_Education/pop/pop55/c05
- Indyk, I. (1988). Parliament House Re-visited *Architectural Review*, 184(1100), 59-60.
- Jasper, M. (2000). *Aspects of a modern urban architecture*. Paper presented at the Romaldo Giurgola Symposium, University of New South Wales, Sydney.
- Johnson, E. J. (1986). *Charles Moore : buildings and projects 1949-1986*. New York: Rizzoli.
- Johnson, R. (1988). Canberra's New Parliament House and its Landscape Design. *Landscape Australia*, 10(2).
- Jury, R. N. A. (2004). Sir Zelman Cowen Award for Public Buildings citation. *Architecture Australia*, 93(6).
- King, M. (1996). Objections Raised Over Plan For New UW Law School. *The Seattle Times*.
- Koerble, B. (1990). Giurgola's Kimbell Addition Draws Fire. *Architecture*(Jan), 35-36.
- Larson, H. (2000). *Collaborative Effort*. Paper presented at the Romaldo Giurgola Symposium, University of New South Wales, Sydney.
- Mänty, J. (1985). *Principles of architecture*. Tampere: Tampere University of Technology. Department of Architecture.
- Margalit, H. (2000). *Romaldo Giurgola - a response to the Philadelphia/New York years*. Paper presented at the Romaldo Giurgola Symposium, University of New South Wales, Sydney.

- Martin, M. (2000). *Red Ochre Cove: the difference between a commission and a work of art*. Paper presented at the Romaldo Giurgola Symposium, University of New South Wales, Sydney.
- McDougall, I., & Mundy, R. (1979). Parliament House Competition: 9 Designs from Melbourne. *Transition*, 1(2), 15-24.
- McKenzie, A. (2004, 2004 November-December). St Patrick's Cathedral, Parramatta, MGT Architects with Romaldo Giurgola, Architect. *Architecture Australia*, 93, 60+.
- Mehta, J. (2011). *Critiquing the Modern: Aldo Giurgola and Louis Kahn in Philadelphia*. Vadodara.
- Miller, W. C. (1979). A Thematic Analysis of Alvar Aalto's Architecture. *Architecture and Urbanism*(No. 109), 15-38.
- Mitchell, E. B., & Giurgola, R. (1983). *Mitchell/Giurgola Architects*. New York: Rizzoli.
- Moore, C. (1973). In Similar States of Undress. *Architectural Forum*, 46-57.
- Morton, D. (1973). Complimenting the past: Mission Park Residential Houses, Williams College. *Progressive Architecture*, 54(2), 56-61.
- Murphy, J. (1988). Parliament House: the building. *Progressive Architecture*, 69(8), 72-75.
- Myers, P. (1981). Water on the Brain: A Canberra-Luxor Axis? , 2(1), 11-13.
- Myers, P. (2000). *The Anatomy of Melancholy*. Paper presented at the Romaldo Giurgola Symposium, University of New South Wales, Sydney.
- Pause, R. H. C. a. M. (1985). *Precedents in Architecture*: Nostrand Reinhold Company.
- Payne, A. A. (1994). Rudolf Wittkower and Architectural Principles in the Age of Modernism. *Journal of the Society of Architectural Historians*, 53(3), 322-342.
- Peake, C., Drew, P., & Anderson, M. (1979). Four Melbourne Architects: Three Reviews. *Transition*, 1(2), 9-14.
- Pelkonen, E.-L. (2009). *Alvar Aalto : architecture, modernity, and geopolitics*. New Haven, Conn. ; London: Yale University Press.
- Quantrill, M. (1983). *Alvar Aalto: A critical study*: New Amsterdam Books.
- Radford, A. (2010). Urban design, ethics and responsive cohesion. *Building Research & Information*, 38(4), 379-389. doi: 10.1080/09613218.2010.481437
- Radford, A., & Oksala, T. (2006). Alvar Aalto and the Expression of Discontinuity. *Draft Working Paper (Unpublished)*.
- Radford, A., & Schrapel, S. (2014). *Dickson and Platten, Romaldo Giurgola, and Aalto's Influence in Australia*. Paper presented at the Aalto Beyond Finland 2015. Conference proceedings retrieved from
- Reid, P. (2002). *Canberra following Griffin : a design history of Australia's national capital*. Canberra: National Archives.
- Rowen, J. C. (1961). Wanting to Be: The Philadelphia School. *Progressive Architecture*, 131-155.
- Schindler, R. M., Smith, E. A. T., Darling, M., Österreichisches Museum für Angewandte Kunst., Museum of Contemporary Art (Los Angeles Calif.), & National Building Museum (U.S.). (2001). *The architecture of R.M. Schindler*. Los Angeles, Calif.: The Museum of Contemporary Art, Los Angeles, in association with Harry N. Abrams.

- Schütz, D. (2010). Ecce Sacerdos Magnus!
- Scully, V. J. (1969). *American architecture and urbanism*. London: Thames & Hudson.
- Sharp, D. (1988). Australian Showpiece. *RIBA Journal*, 95(7), 31.
- Sherwood, R. (1985). Two Sunflowers. 38(3), 21-25.
- Spence, R. (1988). The New Parliament House, Mitchell/Giurgola and Thorp Architects. *Architectural Review*, 184(1100), 36-&.
- St. John Wilson, C. (1995). *The other tradition of modern architecture : the uncompleted project* (New ed.). London: Black Dog Publishing.
- Stanton, P. (1977). Mitchell/Giurgola Architects. In C.-Y. Chang (Ed.), *Process, architecture* (pp. 268 p.). Tokyo: Process Architecture Publishing Co.
- Stead, N. (2004). State of Grace (review of extension to St Patricks Cathedral). *Monument*, 60(April/May), 38-45.
- Steil, L., Hanson, B., Mehaffy, M., & Salingaros, N. (2004). Contrasting Concepts of Harmony in Architecture: The 1982 Debate Between Christopher Alexander and Peter Eisenman. *KATARXIS No 3*.
http://katarxis3.com/Alexander_Eisenman_Debate.htm#Editors
- Stephens, P. H. G. (2008). Book Review: Fox, Warwick (2006) A Theory of General Ethics: Human Relationships, Nature, and the Built Environment. *Organization and Environment*, 21(4), 488-505.
- Stern, R. A. M. (1969). *New directions in American architecture*. London: Studio Vista.
- Stern, R. A. M. (1973). Stompin' at the Savoye. *Architectural Forum*, 46-57.
- Stevenson, A. (2003). Out of the ashes, cathedral to rival best in the world. *Sun Herald*. Retrieved from
http://newsstore.fairfax.com.au/apps/viewDocument.ac?page=1&sy=smh&kw=giurgola&pb=all_ffx&dt=selectRange&dr=10years&so=relevance&sf=text&sf=headline&rc=10&rm=200&sp=nrm&clsPage=1&docID=SHD031130E117072A187
- Taylor, J. (1979). Looking at the Sydney School. *Transition*, 1(2), 4-8.
- Taylor, J. (1982). A High Down-Under, John Andrews, Ranch House in Eugowra, Australia. *Progressive Architecture*, 63(6), 96-100.
- Taylor, J. (1988). Parliament House Symbolism, Mitchell Giurgola and Thorp. *Progressive Architecture*, 69(8), 100-101.
- Taylor, J. (1988). The Ultimate Palace for Democratic Government. *Art & Australia*, 26(2), 264-267.
- Taylor, J., & Buchanan, P. (1980). POST-MODERN PARLIAMENT + MITCHELL-GIURGOLA-THORP WINNING DESIGN AUSTRALIAN COMPETITION. *Architectural Review*, 168(1006), 354-359.
- Thomson, A. (2006). The Voice of the Past: Oral History. In R. Perks & A. Thomson (Eds.), *The oral history reader* (2nd ed., pp. xiv, 578 p.). New York: Routledge.
- Thorne, R. (2002). Interview with Robert Thorne, Project architect for St. Thomas Aquinas Church, Charnwood, Canberra. In S. Schrapel (Ed.). Canberra.
- Tombesi, P. (2000). *The Roman Habitus of Romaldo Giurgola*. Keynote Address at the Romaldo Giurgola Symposium, 18-19 November 2000.
- Tombesi, P. (2003). Back to the future: the pragmatic classicism of Australia's Parliament House. *Architectural Research Quarterly*, 7, 140-154.

- Treib, M. (1998). Aalto's Nature. In P. Reed (Ed.), *Alvar Aalto : between humanism and materialism* (pp. 50). New York: Museum of Modern Art.
- Turnbull, J. (1988). *Architecture Australia*, 77(7).
- "Two Visitors" Centers Exemplify New Park Architecture. (1959). *Progressive Architecture*, 40(2), 87.
- Venturi, R. (1966). *Complexity and contradiction in architecture*. New York: Museum of Modern Art.
- Venturi, R. (1976). Alvar Aalto. *Arkkitehti*, 66-67; repr. in *Progressive Architecture* (April 1977), pp. 1954.
- Venturi, R., Scott Brown, D., & Izenour, S. (1972). *Learning from Las Vegas*. Cambridge, Mass.: MIT Press.
- Vreeland, T. (1977). Mitchell/Giurgola Architects. In C.-Y. Chang (Ed.), *Process, architecture* (pp. 268 p.). Tokyo: Process Architecture Publishing Co.
- Weirick, J. (1989). Don't You Believe It: Critical Responses to the New Parliament House. *Transition*, 27(28), 7.
- Weirick, J. (2000). *Parliament House, Canberra and the Architecture of Democracy*. Paper presented at the Romaldo Giurgola Symposium, University of New South Wales, Sydney.
- Westbrook, N. (1991). St Thomas Aquinas. *Architecture Australia*, 80(1), 40-43.
- Williams, F. P. (2010). Recollections of St Patricks Cathedral. In S. Schrapel (Ed.). unpublished.
- Williams, P. G. (2009). St Patrick's Cathedral Parramatta - a Contemporary Building Speaking to the Past, the Present and the Future. *Australasian Catholic Record, The*, 86(4), 440-449.
- Wittenborn. (1972). *Five architects: Eisenman, Graves, Gwathmey, Hejduk, Meier*. [New York]: Museum of Modern Art (New York N.Y.).

Appendices

Appendix A:

Stephen Schrapel, 'Shifting 'CENTRE' in Australia: Romaldo Giurgola and Alvar Aalto', *Proceedings of SAHANZ 2006*, T. McMinn, D.J. Stephens, D.S. Basson, (eds.), 2006 pp.483-488.

Appendix B:

Antony Radford and Stephen Schrapel, 'Dickson and Platten, Romaldo Giurgola, and Aalto's Influence in Australia', *Aalto Beyond Finland* conference papers, 2015

SHIFTING 'CENTRE' IN AUSTRALIA: ROMALDO GIURGOLA AND ALVAR AALTO

Stephen Schrapel

Candidate for Master of Architecture, University of Adelaide, Adelaide, Australia

ABSTRACT

Romaldo Giurgola is most often spoken about as an American architect aligned to Louis Kahn and the 'Philadelphia School', yet his Italian birth, Beaux-Arts training and fascination with Nordic and Scandinavian architecture played a key role in his design. Although Kahn's conception of an 'inspired way of life' and the 'democratic institution' were central for the practice of Mitchell/Giurgola, Giurgola found the late great master difficult to follow. Like many of the third generation modernist American architects for whom Kahn was a compelling figure - Robert Venturi, Charles Moore - Romaldo Giurgola acknowledges the celebrated Finnish architect Alvar Aalto as a significant influence.

By his design for the Australian Parliament, Romaldo Giurgola mapped his personal biography on the Griffin Plan for Canberra. He continues to practice in Australia, and his importance was highlighted recently in 2004 when the Sir Zelman Cowen Award was awarded to his work for the second time. His pedagogy, architecture and writing bear relevance to the current generation of Australian architects, particularly those who worked in his office during the Parliament project. The paper directs our attention to his role in Australian architecture and the relevance of Alvar Aalto in the shifting ground between fringe and centre in the Australian context.

In his book, "Modern Architecture" of 1979 Manfredo Tafuri claims that the Finnish architect, Alvar Aalto was outside the great themes of change in the modern project and Aalto's historical significance "has perhaps been rather exaggerated"¹. He adds that, "The qualities of his [Aalto's] works have a meaning only as masterful distractions, not subject to reproduction outside the remote reality in which they have their roots."² Notwithstanding Tafuri's assurances many post-war 'third generation' modernists asserted attachment to the celebrated Finnish architect often affording him special recognition.

Romaldo Giurgola, an architect of particular significance for Australia, is amongst a number of those 'third generation' modernists who declared a fascination with Aalto. Despite only two brief personal encounters, Aalto was a compelling figure for Giurgola. It is argued by this essay that Giurgola's epic journey across three continents, "leaving, arriving and arriving again"³: from Italy to the American 'new world' and final resettlement in Australia prompted recollections of Aalto which were mapped onto the Australian landscape. Thus, the discussion also touches on key themes of the post-war period:-

- Reactionary responses to the perceived dogmatism of Western European modernism in the 'new' world (s).
- The émigré architect experience of 'place', 'centre' and 'edge'.

Romaldo Giurgola and Alvar Aalto: A brief portrait

Romaldo Giurgola graduated from the University of Rome in the Beaux-arts tradition in 1948 and subsequently, as a Fulbright Scholar, received the Master of Science in Architecture from Columbia University in 1951. In the same year, following a short return to Italy, Giurgola left his Italian birthplace to permanently resettle in the United States, leaving behind him a very personal experience of the violent confrontation of ideologies accompanying the Facist regime in Italy. In 1954 Giurgola gained the position of Professor of Architecture at the University of Pennsylvania and was joined by Louis Kahn in 1955. With Kahn, Giurgola had a direct relationship. Giurgola and Kahn were close friends during Giurgola's tenure as Professor at the University of Pennsylvania and Giurgola provided the first comprehensive assessment of Kahn's work with the publication of the book, *Louis I. Kahn*, with Jaimimi Mehta, in 1976.

Most accounts of Giurgola's career parallel his work with Kahn's. However many authors also note a departure from Kahn's rigorist approach attributing the deviation to Giurgola's Romo-centricity and alignment to a leftist politic. Robert Stern notes, for example, that, "Romaldo Giurgola is a more expansive and less intense talent than Venturi or Kahn's, from which it has drawn so much sustenance. An Italian by birth, his is a sensibility that sketches with soft lines and gently shaded areas." ⁴

Kenneth Frampton wrote in 1983 in his foreword to the monograph, *Mitchell/ Giurgola Architects*,

Ehrmann Mitchell and Romaldo Giurgola have been long regarded as representatives of the Philadelphia School, although clearly they, like the other pupils and colleagues of Louis Kahn, have found the late modern master difficult to follow. Thus despite his homage to Kahn – the book *Louis Kahn* of 1975, written with Jaimini Mehta – Giurgola's own work has tended to side-step the direct influence of the Philadelphia master [...]Giurgola's empathy for the social democratic policies of postwar Europe no doubt helped to remove him from Kahn's commitment to the cultural aims of the American New Monumentality.

Mitchell/Giurgola have distanced their work from Kahn in a variety of ways. In the first instance they seem to have been attracted to the superficial aspects of the New Monumentality, as this appeared in the more structurally ostentatious works of Eero Saarinen. This tendency announced itself briefly in the Wright Brothers Memorial Visitors Center [...] Soon after, however, they shifted their affinities to the more organic side of European Brutalism; to that complex sensibility, typified by Aalto's House of Culture, built in Helsinki in 1958 [...] by the same token, Aalto's Baker House of 1948, is clearly latent in the spread-eagled layout of the Mission Park Students dormitory built at Williamstown in 1972, [...] Aalto's influence is again detectable in the interiors of Giurgola's lecture halls and libraries as one may judge from, say, the Lang Music Building, Swarthmore (1973) or the Tredeffrin Public Library, built at Strafford, Pennsylvania in 1976.⁵

Aalto pointed a way forward for many of the influential North American architects of the second half of the 20th Century, resolving their shift away from the dogmatic application of the modernist

style that accompanied the meeting of modernism with the mainstream. Robert Venturi, Charles Moore and Giurgola continued to advance Aalto's principles, through the development of the apparent philosophical stand-off on the East Coast of America. One camp characterised as the Whites – those concerned with form – and the opposing group, the Grays – those, including Giurgola, concerned with content.

Charles Moore also aspired to Aalto's achievements in the relationship between nature and human activity. Before moving to his more unrestrained eclecticism, Moore's Sea Ranch made extensive reference to Aalto. At the Jobson and Johnson Houses Moore combined the pyramid roof of Kahn's Trenton bathhouse with Aalto's device of intersecting an extrusion of the plan with a dominant roof form such as the Villa Carre.

By the publication of his manifesto *Complexity and Contradiction* in 1966 Venturi became a key figure, over-shadowing Giurgola, and prompted a re-assessment of Aalto's architecture and its Italian precedence.

For the prominent Yale historian, Vincent Scully Venturi and those close to Kahn were the future for American architecture. He announced in his foreword to Venturi's book that Giurgola, Moore, Vreeland, and Millard are "...the best young American architects and educators of the past decade..."⁶, attributing their rise to their adherence to Kahn's teaching. He goes further to say that Aalto and Aldo van Eyck, together with Louis Kahn were the principle influences on Venturi's development.

Venturi himself acknowledges his debt to both Aldo van Eyck and Aalto; to van Eyck for providing the concept of the 'in-between' and to Aalto for his humanism. Aalto provides a constant reference for Venturi's book where he places Aalto clearly in his 'both-and'type. He writes,

Inherent in an architecture of opposites is the inclusive whole. The unity of the interior of the Imatra church or the complex at Wolfsburg is achieved not through suppression or exclusion but through the dramatic inclusion of contradictory or circumstantial parts. Aalto's architecture acknowledges the difficult and the subtle conditions of the program, while "serene" architecture, on the other hand, works simplifications."⁷

In the year following the death of Aalto in 1976, the American journal *Progressive Architecture* published a testimonial to Aalto and invited contributions from Robert Venturi, Giurgola, Gunnar Birkerts, George Baird, Ake T. Tjeder, Klaus Dunker, Nory Miller and Martin Price. Venturi wrote of his profound regard for Aalto,

Alvar Aalto's work has meant the most to me of all the work of the Modern Masters. It is for me the most moving, the most relevant, the richest source to learn from in terms of its art and technique [...] When I was growing up in architecture in the 1940s and 50s Aalto's architecture was largely appreciated for its human quality, as it was called, derived from free plans which accommodated exceptions within the original order, and from the use of natural wood and red brick, traditional materials introduced within the simple forms of the industrial vocabulary of Modern architecture. These contradictory elements in Aalto's work connoted – rather paradoxically it seems now – qualities of simplicity and serenity... I think we can learn timely lessons about monumentality from Aalto's architecture because architectural monumentality is used indiscriminately in our time and it wavers between dry purity and boring bombast. Aalto's monumentality is always appropriate in where it is and how it is used, and it is suggested though a tense balance again between sets of contradictions.⁸

Giurgola, for his part in the tribute to the late master in 1976, recalled an influential article from his formative years in Italy:

At the end of WW2, while it was yet impossible to perceive the immensity of destruction, a debate on the merits of rebuilding towns on new sites went on in Italy. Architects of the Bauhaus logic, aggressive as ever, generally favoured the construction of new places, down from the medieval hills into the valleys, close to rails, airports, and industries.

At that time Casabella translated one of the very few writings of Alvar Aalto: commenting on the destruction of war, he suggested that if the only relic of a burned down house was the brick chimney, that alone was a good reason to build again in the same place, piece by piece [...] For Alvar Aalto needed a sign to begin, his aspiration was toward a place, a new place with a tie to the past, however tragic [...] I was very affected by that.⁹

In 2001 with a lecture entitled, "A Journey Through Architecture" Giurgola recalls the years following the upheaval in the 1960s,

Following those years the new terminology invented to categorise

contemporary architectural design (such as 'constructivism', 'deconstructivism', 'post-modernism' and other '-isms') did not help in penetrating the real meaning of a work of architecture.

As for slogans, I remember some years later visiting our old colleague and friend Robert Venturi in Philadelphia, and noticing on the wall of his office the words, "we make buildings that look like buildings".

Throughout that period our paradigms nevertheless remained the work of Louis. I. Kahn and Alvar Aalto: Kahn for the sense of order of the building concepts, without which the content of a building would be easily swamped, and Alvar Aalto for the spiritual identification of this work with his native landscape and with nature.¹⁰

Despite the disparate directions of those close to Kahn, Venturi was the catalyst for a re-assessment of Aalto's architecture. Giurgola's recollection of Aalto was re-inforced by the alignment of the crystallisation in Venturi's manifesto with his first impression of Aalto.

Giurgola 'Down-Under'

As White/Gray shifted towards its final polarity (and eventual dispersal) represented by the almost coincident publication of *Five Architects*¹¹ and Venturi's *Learning from Las Vegas*, Giurgola began he design for two major buildings, the Volvo Headquarters in Gothenburg, Sweden and the Australian Parliament. The Volvo building provided Giurgola with an opportunity to explore his formulation for community in the workplace and several of the devices he later employed in the Australian Parliament building: the monumental screen, the relationship of office accommodation against circulation, and the turning over of surfaces to the working of artists. Also significant was the time it allowed Giurgola to spend in Sweden and neighbouring countries, producing many landscape sketches of the Swedish countryside during his visits.

Increasingly during these years Giurgola was attracted to the work of Nordic and Scandinavian architects, Eliel Saarinen, Guntar Asplund, Jorn Utzon, and Alvar Aalto. Together with Pamille Berg, a then associate in The United States firm of Mitchell/ Giurgola and later the partner in charge of Art Programs for the Australian Parliament and the church of St Thomas, he pursued and received a grant to compose a book on the architecture of Eliel Saarinen. The book was eventually abandoned due to the pressures of the Parliament project but Pam Berg comments that the work of Saarinen and the Nordic architects were foremost

in the mind of Giurgola as he began work in Australia. At the Volvo Headquarters Giurgola had commissioned the Danish textile and ceramic artist Lin Utzon for a porcelain mural, carpets, and other special items following her interior work for the Bagvaerd Kirke of Jorn Utzon. The Bagsvaerd Kirke proved instrumental in the formulation of the later St Thomas Church and appears in Giurgola's early sketches.

In 1981, describing the 'Producing Moment' of Parliament building, Giurgola poetically recalls his visit to Stockholm at the age of nineteen;

Buildings were painted in the big skies like plants emerging from the trees and, like them, made of wood with the colour of bright flowers. I walked the streets of Stockholm at four in the morning, without meeting anyone, early sunlight blasting on the building fronts, sharpening the details. There were guilt feelings at being a thief, of having broken that magic, and the city, a model of that magic, still incredulous of its own existence, awaking human deluge. Then came the scream of the first morning streetcar, turning joyfully on the square. Was architecture just dreams? If so, I went to see the man of my utopia, Gunnar Asplund, whose library in Stockholm had a ramp up to the circular room with books all around, the sunlight moving along the tiers like the hands of a gigantic clock.

Asplund talked as if his works were far from him, the efforts of someone else. His home was like a glove, small. The wood floor extended into the paths outside, toward a distant meadow, meeting with the intense blue sea.

Could architecture ever be just a synthesis of technical, social, and economic concerns after this? Was it synthesis – the residual of centuries of buildings – that made my Rome or Asplund's Stockholm? Or was the architecture the fragments of an interlocking experience, including both past and present, revealing and serving a moment of our own existence?¹²

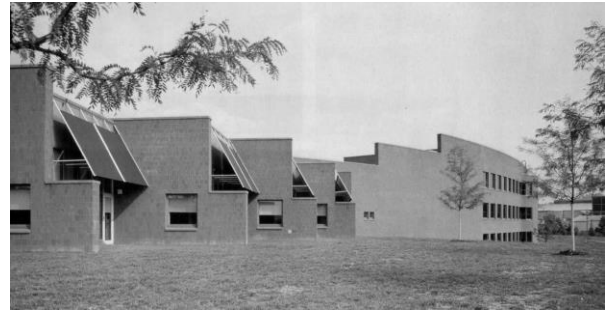

Source: (Mitchell/Giurgola Architects. 1983, Rizzoli: New York)

Figure 1. Lukens Steel Company, Pennsylvania (1979)

Form studies: Australian Parliament

While comparisons have been drawn with the Griffins' ziggurat design for their Capitol building¹³—no doubt a key contribution - Giurgola's concern with form silhouette precedes the Parliament. Non-urban buildings such as the MRDT Foundation Hall of 1972 and his work throughout North America display stepped figures against the horizon, a disregard for which was an early casualty of modernism.¹⁴ Frampton notes of Giurgola's 1976 Volvo Assembly Plant built at Chesapeake, Virginia and the Lukens Steel Company [FIG. 1] administration building realized in Coatesville, Virginia in 1976, that the latter is the,

...more Scandinavian of the two, inasmuch as its parti is indebted equally to Aalto and Asplund – to Aalto for the compositional device of ordering irregular masses against a straight line (as in Aalto's Leverkusen Cultural Centre project of 1962) and to Asplund for the deployment of a series of free-standing orthogonal pavilions, running in front of a suppressed mass, as in the funerary chapel entrances to the Woodland Cemetery Crematorium, Stockholm, of 1940¹⁵.



Source: (Author 2006)

Figure 2. Australian Parliament

The two parliamentary chambers, the Senate and the House of Representatives, are roofed to a similar scale, materiality and form to that of the surrounding Canberra suburban houses - elevating the ordinary to the extraordinary. Together with the

stepped retaining walls, the suburban elements amplify the scale of the monumental flagpole and aspire to Aalto's principles of silhouette design. The dualistic form arrangements provide special emphasis, in this case, the crowning flagpole, recalling also the contradictions in Venturi's Vanna Venturi House (1964) and Guild House (1966).

St Thomas Aquinas Church

The most arresting case in Australia for Aalto's influence occurs with the St Thomas Aquinas Church, a building immediately following the Parliament. The parish priest, Father Drinkwater, organised a limited, invited competition for the design of a new parish chapel to adjoin an existing school and presbytery.

The church is arranged into discrete volumes with the central mass given scale as it rises to the East in a 'head/tail' configuration¹⁶ so often associated with Aalto. Along the south elevation, the nave and altar are given importance by the relationship to the servant aisles, narthex and presbytery volumes. This motif is repeated along the east façade, where the vertical thrust of the dominant facade is accentuated by the long low horizontal wall of the adjoining cloister, connected to the horizon and the earth.

It is Aalto's *Maison Carré* that solves the challenge of draining a large skillion roof with the three slicing gutters. The terracotta material choice, as in the Parliament building, repeats the qualities of the presbytery and the roof forms of the commercial district and suburban houses. Giurgola is very particular about this point in a letter to Pamille Berg sketching out the kernel of ideas for the church. He states, "This [sic] walls repeat the simple approach of the parish house, same bricks, tile roof like for the Chambers."¹⁷

The East façade is the most pronounced occasion of Giurgola's contextualism for the St Thomas Church. The small domestic element leaves an unerring impression. There is a gestalt shift between the resonance of a 'lean-to' structure associated with the neighbouring suburban structures and its position in forming the cornerstone to the monumental facade.

The contextual motif turns the corner where Giurgola uses a rough faced brick, reiterating a materiality and scale of the existing presbytery and suburbia. Behind the aisle stands the enclosing wall of the main volume, the nave, made in a smooth face brick and painted white. Here Giurgola plays with the ambiguity associated with the wall and introduces a material collage of the surrounding context. Symbolically the nave gives a clean figure against the sky, the heavens, while the aisle is tied to the earth and the human dimension.

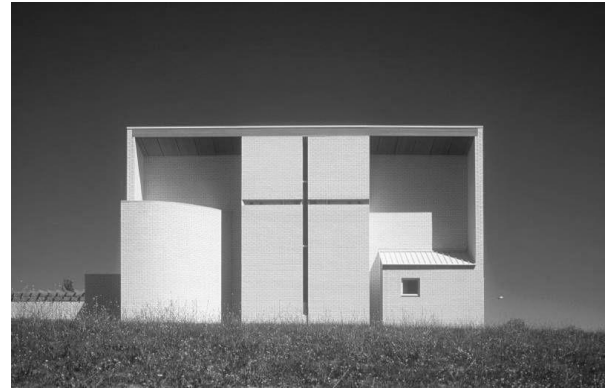

Source: (John Gollings 1989)

Figure 3. St Thomas Aquinas Church from East

New Possibilities through 'Arrival'

Aalto's influence appears sporadically in Giurgola's work in North America. There, he transformed and refined his language until his mature phase in Australia where Aalto is foregrounded in his mind by what Giurgola describes as an "absence of limits"¹⁸. Each chapter of Giurgola's career intensified the focus: in Italy, the debate over rational/organic directed by Bruno Zevi highlighted the contribution of Aalto; in North America the White/Gray polemic and Venturi announced Aalto as a heroic figure, and finally in Australia, untangled from the claustrophobia of Italy and the complexity of North America, Giurgola transposed his recollections of Aalto to a new frontier. Kahn's ideals for the 'inspired institution' were central to Giurgola but Aalto offered clues to resolving his *Roman Habitus*¹⁹ in Australia. For the Parliament building he says, "I was wary of doing a bureaucratic building - a monumentality per se."²⁰ In opposition to Kahn's heroic Parliament for Dacca, Giurgola sought to produce a 'gentle' monument related to the openness of the Griffins' plan, "In the tension between abstraction of architecture and physical reality"²¹.

By the sense of 'arrival' in the Australian landscape, Giurgola is tied to his fellow Italian migrant, Enrico Taglietti. While Taglietti arrived years earlier in Canberra, the city opened for both a new space of possibilities. Recalling his first impressions in his 2001 lecture to the University of Sydney, Giurgola writes,

...before the time of the design competition, my knowledge of Australia derived mainly from literature with all its preconceptions. I had known Canberra, however, 'on paper' since my school years. As students we all wondered at the magnificent plan of Walter Burley Griffin, but of course we didn't know at the time that actually very little of it was built. For me, walking later on the tracks of that plan and the dry native grass of Kurrajong Hill at the outset of the

competition was an emotional experience indeed.²²

And Taglietti,

On a clear September afternoon many years ago – wattle and prunus in flower, mountains sprinkled with snow – I reached in a Fiat 500 the city of Canberra. A city without cathedrals, a city without a past. It was the dream of any modern architect. The nothingness was there: the silence, the music, the tabula rasa (a clean slate), the end of exploring perhaps the destination, the invisible city.²³

Giurgola's route to Canberra is very different from that of Taglietti but it is these highly personal and romantic visions that come to narrate significant architectural themes of the post war period. This is not to argue that 'place' precedes the story²⁴. Rather, the directing of Giurgola's personal transformation from 'critical outsider to mainstream insider'²⁵ shifted the ground, intensifying his interest in Aalto.

¹ Manfredo Tafuri and Francesco Dal Co; translated from the Italian by Robert Erich Wolf, *Modern architecture*, New York: H.N. Abrams, 1979, p. 305.

² Manfredo Tafuri and Francesco Dal Co, *Modern architecture*, p.305

³ The title given to the September presentation regarding Romaldo Giurgola in the series of Tuesday night talks held by the NSW chapter of the RAI, 2006.

⁴ Robert Stern, *New directions in American architecture*. London: Studio Vista, 1969.

⁵ Kenneth Frampton, Foreword to *Mitchell/Giurgola Architects*. Rizzoli: New York, 1983, pp. 8-10.

⁶ Vincent Scully, Introduction to *Complexity and contradiction in architecture*. Museum of Modern Art: New York, 1966, pp. 9-11.

⁷ Robert Venturi, *Complexity and contradiction in architecture*. New York: Museum of Modern Art, 1966, p. 102.

⁸ Robert Venturi, 'Alvar Aalto,' *Arkkitehti*, (1976): 66-67; repr. in *Progressive Architecture* (April 1977), p. 54.

⁹ Romaldo Giurgola, 'Design and Planning: Alvar Aalto.' *Progressive Architecture*, (April 1977): pp. 53-57

¹⁰ Romaldo Giurgola, 'A Journey Though Architecture.' Lecture read at The University of Sydney in the Vice-Chancellor's Sequicentenary Distinguished Lecture Series, 18th October, 2001.

¹¹ Wittenborn (ed), *Five architects: Eisenman, Graves, Gwathmey, Hejduk, Meier*. 1972, Museum of Modern Art: New York.

¹² Romaldo Giurgola, 'The Producing Moment', *Inland architect*, 1/1981. p. 39.

¹³ Deborah van der Plaats and Maryam Gusheh, 'The Idea Of the Liberated Imagination In Walter Burley And Marion Mahony Griffins' Capitol Building (1921),' *Limits: proceedings from the 21st Annual Conference of the SAHANZ 2004*. Melbourne: Routledge, 2004, p. 392.

¹⁴ Andres Duany by his article in the *Harvard Architecture Review*, 1986, "Principles in the Architecture of Alvar Aalto", asserts that Alvar Aalto systematically composed form considering the human perspective with a strategy of constructed silhouette.

¹⁵ Kenneth Frampton, Foreword to *Mitchell/Giurgola Architects*.

¹⁶ Andres Duany, "Principles in the Architecture of Alvar Aalto."

¹⁷ Romaldo Giurgola in a letter to Pamille Berg, 1986, describing his first ideas for the St Thomas Church, Canberra.

¹⁸ Interview with Romaldo Giurgola, March 2002: Canberra.

¹⁹ Paolo Tombesi has provided an account of Giurgola's formative experience in the context of the Italian profession and the Italian city of the XX century years as the key note address to the symposium commemorating the 80th birthday of Romaldo Giurgola entitled, "The Roman Habitus of Romaldo Giurgola". Read at the University of New South Wales, November 2000.

²⁰ Interview with Romaldo Giurgola, March 2002: Canberra.

²¹ Romaldo Giurgola, 'A Journey Though Architecture.'

²² Romaldo Giurgola, 'A Journey Though Architecture.'

²³ Harry Marglit and Paola Favaro citing Enrico Taglietti in 'The Local And The Migrant: Limits of Mutual Recognition,' *Limits: proceedings from the 21st Annual Conference of the SAHANZ 2004*. Melbourne: Routledge, 2004, p. 314. Originally cited in Peter Robinson, 'Visions of reality through the

buildings of dreams', Panarama section of The Canberra Times, (October 10, 2001): pp. 4-5

²⁴ Harry Marglit and Paol Favaro argue in, 'The Local And The Migrant: Limits of Mutual Recognition,' that Taglietti's story would precede the place with little loss of coherence. p317.

²⁵ M. Jay quoted by Stephen Cairns, (ed) *Drifting: Architecture and Migrancy*, London: routledge 2004, p29.

Aalto Beyond Finland

Dickson and Platten, Romaldo Giurgola, and Aalto's Influence in Australia

Antony Radford and Stephen Schrapel

School of Architecture and the Built Environment, The University of Adelaide,
Australia.

Abstract

Aalto's influence in Australia is examined, focusing on the work of Dickson & Platten (Robert Dickson (1926 – 2014) and Newell Platten (1928 –)) and Romaldo Giurgola (1920 –). The firm of Dickson & Platten was a leader of the so-called 'Adelaide Regional Style' of Australian architecture. Italian-American-Australian Giurgola has been a partner in several firms and designer of a series of accomplished buildings in Australia as well as the United States, Italy and Sweden. He is best known as design architect of Australia's Parliament House in Canberra. Other architects and practices briefly examined are those of Glenn Murcutt, Candalepas Associates, Ashton Raggatt McDougall, and John Wardle.

Aalto and Australia

Despite its location on the globe, Australian architecture follows the European/American 'western' tradition in line with the cultural background of the majority of its population.¹ Its architecture schools and their curricula have developed from British models, with the same English-language books and journals prominent in education and in professional discourse.

Modern architecture was only gradually recognized in architecture schools, although 'between 1929 and 1939, many young Australian architects travelled overseas almost as a right passage and were exposed to Europe's 'new architecture''.² In the 1990s Paul-Alan Johnson interviewed twenty-four architects educated during the 1930s and 40s. An architect educated in Geelong in the early 30s recalled that 'Classical, Gothic and Renaissance were the core of the course there'. Asked directly about overseas architects, half professed an interest in 'the Dutchman, Dudok. the brick man', especially his Hilversum Town Hall, Frank Lloyd Wright came a close second, Gropius was mentioned by six, and Aalto by four.³ As an architecture student in Adelaide between 1946 and 1951, Newell Platten was 'taught Classical architecture, nothing else.' The 'History of Architecture ended in the Renaissance and never got out of Europe – nothing on Japan, or South America.' But 'what the students were teaching each other was the Bauhaus, Le Corbusier, Frank Lloyd Wright, etc.' Aalto 'would not have been one of the heroes' of the students at that time.⁴ Robert Woodward (1923-2010), a student in Sydney from 1947-52, was advised in London to visit Finland when he travelled after graduation and worked in Aalto's office for a year. He was impressed by 'Aalto's multi-disciplinary approach where landscape is involved in the building, and interior design, lighting, furnishings, fabrics. ... I think Aalto's main contribution, and this is to put it very simplistically ... was that he was able to get the best of Bauhaus as well as organic work.'⁵ Returning to Sydney in 1954, Woodward went on to become a leading designer of fountains.

Other notable Australian architects (including Keith Cottier (1938 –) visited Finland in the 1950s, often from a base working in London, as a reaction to modernism gradually emerged.⁶ Nevertheless, Glenn Murcutt and his fellow final-year architecture students in Sydney in 1961 still 'knew a lot about Frank Lloyd Wright, Le Corbusier and Mies van der Rohe' but 'didn't hear much about the Scandinavians like Alvar Aalto. ... He was just that guy somewhere up there in the Northern Hemisphere'.⁷

A little later, in 1964, Albert Gillisen joined the school of architecture in Adelaide to teach history and theory (he had visited Finland in 1961). 'The four big names were Corb, Gropius, Mies and Wright. Aalto and Neimeyer followed as the second generation.' But through the 1960s 'Aalto was at the back of my mind for integrated, holistic design, and his humanism, yet so full of vitality and creativity.' He met Aalto in Helsinki in 1969 ('we talked over a bottle of Chianti').⁸

Aalto became a more prominent figure in the teaching and discourse of Australian architecture through the 1960s and 70s, with more students and architects becoming aware of his work and visiting Aalto's buildings in Finland and elsewhere. Looking back in 1998, Davina Jackson, then editor of the Australian professional magazine *Architecture Australia*, wrote:⁹

'Aalto's key projects have been a vital source for some of Australia's most resonant works of architecture since the late 1950s. Elements of his tuberculosis sanatorium at Paimio (1928-33) are visible in various antipodean hospital blocks and apartment towers. Dozens of east coast beach houses owe debts to the Pacific-Japanese interiors, lawn-pool court and timber batten plays of his Villa Mairea at Noormarkku (1937-39). And how might our institutional buildings of the 1960s and 1970s have been designed without the precedents of Aalto's town and university complexes at Seinäjoki (1958-87), Jyväskylä (1951-76) and Saynäsälö (1950-52)?'

As a very crude quantitative comparison of the influence of some 'modern masters' up to 2012, the index to the comprehensive *Encyclopedia of Australian Architecture* published in that year shows 29 page references to entries where 'Aalto' is mentioned, more than 'Gropius' (20), 'Le Corbusier' (22) and 'van der Rohe' (15), but fewer than 'Wright' (54).¹⁰

Colin St John Wilson (whose own design for the British Library in London is deeply influenced by Aalto) casts Alvar Aalto as a leading figure in what he calls the 'other tradition' of modern architecture, one that continually emphasizes designs that respond to specific physical and social contexts rather than the expression of abstract theories.¹¹ In this paper we examine the work of the firm of Dickson and Platten, a partnership between Robert Dickson (1926 – 2014) and Newell Platten (1928 –), a leader of the so-called 'Adelaide Regional Style' of Australian architecture, and Italian/American/Australian architect Romaldo Giurgola (1920 –), designer of a series of accomplished buildings in Australia as well as the United States, Italy and Sweden, and best known as design architect of Australia's Parliament House in Canberra. They show a similar priority for solving local problems, downplaying style, and share Aalto's concern for materiality and human scale, sometimes adopting forms and patterns that appear to reference Aalto's buildings. It is, though, impossible to 'unpick' the many influences on their practices and to be definitive about what 'comes from' Aalto and what 'comes from' other sources, including 'second hand' precedents. As a leader and adept self-publicist, Aalto influenced others from the early days of his practice. Indeed, Jackson goes on to note:

'It has been suggested that Aalto's influences on Australian architecture before the 1970s were often indirect—that the Aaltoesque elements of some local projects came second-hand from *Architectural Review* pictorials of tributes designed by his acolytes in Britain.'¹²

Concentrating on just a few buildings, we shall point to similarities of intent and form between Aalto's work and that of Dickson and Platten and Giurgola without seeking

to trace a trail of influence. We shall then briefly consider some other Australian architects whose work shares values and sometimes formal expression with Aalto's work.

Robert Dickson

Dickson described his design process as solving problems, without thought of aesthetics or style. Hurst (2002) describes his work as 'an unselfconscious architecture' and quotes him:

'When designing I do not think about style. Style to me is irrelevant. Like handwriting, it is one's unselfconscious mark. But I do think very much about 'technique' and work very hard to resolve issues. My belief is that one should always seek to let the problems lead to the solution.'¹³

Dickson's style developed over 45 years from the first stage of his own house in 1949 to his late projects. After graduation in Adelaide, he worked in London for Sir Denys Lasdun and then in Milan for Professor Angelo Mangiarotti in the years 1955 to 1957. His work is strongly influenced by the Milan style known to Italians as Scuola di Milano, using raw concrete, brick, timber and tiled roofs in rationalist forms that echo Aalto's work and respond to the ideas of the early Urban Morphologists.¹⁴ He developed what he learnt in Italy into a personal and distinctive style and was widely imitated. Much later, around 1972, Dickson returned to Italy and northern Europe and met Aalto in Helsinki. He felt a sense of shared vision, of shared values.¹⁵

Like Aalto, Dickson used a palette of 'natural' materials and finishes with only rare use of colour. In Dickson's architecture it included light brown stained timber, brickwork walls and paving, strawboard ceiling panels, off-form board-marked concrete, natural stone and (in large buildings) precisely detailed precast concrete. He used 'shadow joints', where corners in touching materials or masses are incised by square-section indents. Internal spaces extend to the limits of their possible enclosure, such as the underside of upper floorboards for a lower floor and the underside of sloping roofs for an upper floor, with the structure revealed.



1: Union House, Adelaide (Robert Dickson) 1968-75, East side and bookshop roof

Union House (stage 1 1967-71, stage 2 1973-75) in The University of Adelaide has all of these characteristics (figure 1). Its materiality of red brick, clay tiles and fine-finished concrete echoes Aalto's work of his 'brick' period. The asymmetrical composition of the elements of the east façade has echoes of Aalto's Säynätsalo Civic Centre (1949-51), with its 'incomplete' corners, rich texture and incised

openings. Inside, the exposed timber trussed roof structures, especially the roofs of the bookshop and the upper gallery, recall Aalto's roofs in, for example, the cafeteria and original swimming pool at Jyväskylä. Dickson's timber-framed roof of the 12-sided ballroom of the Arkaba Corner Hotel in Adelaide (1964-66) is an expression of structure quite different in form but similar in expressive power to Aalto's famous twin 'butterfly' trusses that support the roof of the council chamber at Säynätsalo.

Newell Platten

From 1958 to 1973 Dickson was in partnership in Adelaide with Newell Platten (1928 –).¹⁶ Platten has never been to Finland, and only visited one Aalto building: Baker House in Cambridge, Mass., USA. For two years as a young architect he worked in the celebrated Athens office of Doxiadis Associates. Sigfried Giedeon, author of the enormously influential book *Space, Time and Architecture*,¹⁷ visited the office in 1962. Platten remembers Giedeon telling them that architecture was generally 'going the wrong way', with architects (particularly in certain parts of the USA) being too egotistical, in love with their own architecture. Aalto, Giedeon said, was the exception. Aalto was in love not with architecture but with life. 'This appealed to me and Bob [Dickson]', making buildings that were emotionally attractive to people, with the use of craft and hand building. It implied that 'you subordinate your architecture to the people who will live in it, will use it.' Aalto 'influenced a lot of architects of our generation – his warmth, his humanity'¹⁸

'When I was in America as a young architect, just graduated, I saw works by Aalto, Frank Lloyd Wright and Mies van der Rohe. Mies's work was far too perfect for the cut and thrust of ordinary life; people do not live like that. One should not be overwhelmed by one's surroundings. Wright's work was unattainable; how does an architect find the people, those craftsmen, to do that? So of all these three, Aalto was the most accessible.'

The office of Dickson and Platten 'never had Aalto up on the shelf and thought we were trying to emulate him. We had already moved in that direction. But when we saw something published on Aalto we took note. We would just look at the work he had done.' The directness of his architecture – the way, for example, that Aalto put windows where they were needed with the size that was needed – gave Dickson and Platten confidence that they 'could keep pointing along in that direction'.



Figure 2: Kathleen Lumley College, Adelaide (Newell Platten) 1967

Platten designed many delightful houses and house groups (he left the partnership to join the South Australian Housing Trust, a State Government organization, where he could better influence public housing). While Dickson was leading the Union House project, Platten led the design of Kathleen Lumley College (1967) (figure 2), also for

The University of Adelaide. The site context is very different from Aalto's Baker House, but there are parallels in the use of brickwork and timber, the giving of individual identity to student rooms in the ways they are organized and approached, the club-like common rooms and the overall robustness of design elements.¹⁹

Like Aalto, either Dickson or Platten took close personal control of the projects under their name, in an office where staff learnt and understood their 'ways of doing things'. Which details are their own direct works, and which their staff contributed, is not evident in looking at the buildings. Gerry Nelson, an 'excellent' Dutch draftsman who worked for many years in the office, contributed to Union House, Kathleen Lumley College, and other projects, but most staff at this time were transient, with no time to build up a deep knowledge and understanding of the office's design language.²⁰

Romaldo Giurgola

Although not a 'home-grown' Australian, Romaldo Giurgola, in the latter part of his career in Australia, displays a growing interest in Alvar Aalto, with Giurgola finding that Aalto's architecture had affinities with the Australian context.²¹ Giurgola's fascination with Aalto began during his graduate architectural studies in Rome, later recalling a visit to Aalto in his studio at Tiilimäki 20 that made a lasting impression on him.²² In the 1960s to 70s, examples of Mitchell/Giurgola buildings such as the Mission Park Residential Houses (1972) and the Lukens Steel Factory Administration Building (1976) are indebted to Aalto. The undulating layout of Mission Park Residential Houses owes its organization to Aalto's Baker House, and the Lukens Steel Factory to Aalto's compositional device of ordering irregular shapes against a straight line. The view of Giurgola's work from that period is however most often associated with Louis Kahn, Robert A. M. Stern and Robert Venturi and the 'Philadelphia School' and the discussions around urban place-making on the East Coast of the United States.

Addressing the theoretical underpinnings of Mitchell/Giurgola's architecture, David Bell was the first to link Giurgola and Aalto. In his 1979 essay entitled 'Unity and Aesthetics of Incompletion in Architecture', Bell describes incompleteness as a symbol of the ability of all things to become something else, and therefore essentially human.²³ For Bell, this appearance of being finished and yet unfinished surpasses conventional perceptions of time. Architecture that displays these characteristics therefore emphasizes the continuous process of building, mirroring the complex and perpetual development of communities and cities. Bell suggests the unlikely grouping of Aalto, Kahn, Robert Venturi, Giurgola and Peter Eisenman as illustrative examples of his aesthetic of incompleteness. Aalto's choice of materials such as brick, stone, and tile, having rough and imprecise character, effectively incorporate their own ultimate demise and thus acknowledge the force of nature.²⁴ This idea of incompleteness can also be seen in Giurgola's own writings, as he often discusses the nature of buildings as fragments, and the importance of a dynamic and continuous relationship between a building and its surroundings. He wrote in 1965 in favour of a 'partial vision' over the 'pretence of an abstract global image'.²⁵

A mutual space relationship does exist: a building introduced into an environment that already has its structural definition (or is in the process of receiving one) is affected by its situation, and vice versa....In a word, it should relate to the whole of the surrounding conditions, and no geometric rule should really reduce or interfere with this connection.

Mitchell/Giurgola and Thorp's 1979 winning entry for The New Parliament House competition brought Giurgola to Australia. When completed, reviewers characterised it as a typical example of the pastiche Post Modern. Despite this generalised label,

the Parliament displays qualities that fit with the concept of incompleteness and values described by St John Wilson's 'other tradition', namely the indistinctness that Giurgola produces in changes of scale and materiality. For the roofs over the two chambers of government, for instance, Giurgola selected terracotta tiles that appear incongruous against the scale, materiality and restrained posture of the overall building, creating a deliberate confusion. It was also during the 1970s that Giurgola's closer experience with Scandinavia came about through the expansion of Volvo into North America. Mitchell/Giurgola Architects was commissioned to design an extension to a Volvo factory in Chesapeake in Virginia that led to a decade-long cultural exchange between the Swedish car maker and Giurgola's office. Giurgola travelled extensively through Sweden, sketching the landscape and villages, with a particular interest in church buildings, noting that, 'the Scandinavians like the window near the edge of the wall, not in the centre... In Scandinavia it is as if the building is painted into the atmosphere...' ²⁶

In 2001 at the University of Sydney, Giurgola spoke more explicitly of his admiration for Aalto in a lecture entitled, 'A Journey Through Architecture', recalling the 1960s in North America, ²⁷

Following those years the new technology invented to characterise contemporary architectural design (such as constructivism, de-constructivism, post-modernism and other -isms) did not help in penetrating the real meaning of a work of architecture...our paradigms nevertheless remained the work of Louis Kahn and Alvar Aalto: Kahn for the sense of order of the building concepts, without which the content of a building would be easily swamped, and Alvar Aalto for the spiritual identification of this work with his native landscape and with nature.



Figure 3: St Thomas Aquinas Church, Canberra, ACT, 1986-91 (Romaldo Giurgola) (photographs by John Gollings, © Guida Moseley Brown Architects)

It is Giurgola's work beyond the parliament building in Australia, however, that is of greatest interest. The St Thomas Aquinas Church (1986-91) (figure 3) located in Charnwood, an out-lying suburb on the periphery of Canberra, bears an uncanny resemblance to Aalto's Villa Carré. With its long skillion roof inflected up towards the place of religious celebration and graduation of materials from broken faced brickwork in the aisles to a smooth faced central volume, the building repeats the head and tail motif so often associated with Aalto. To reduce the amount of roof water collecting at the low edge of the skillion, Giurgola's technical resolution of the long skillion roof was borrowed directly from Aalto's invention of an interwoven pattern of gutters in the Villa Carré. But the building's indebtedness to Aalto goes beyond outward appearances in similar ways to the Parliament. As in the Parliament, Giurgola included elements and relationships that are deliberately indistinct. The cloister adjoining the main worship space, for example, appears at first glance to follow the form of a traditional courtyard. On closer inspection, the enclosing walls

are punctured with rectangular openings that frame distant views while other walls are broken into fragments allowing the surrounding bushland to slip through. The sacristy, a smallish element of the larger monumental end wall, is executed as a lean-to domestic scale structure. The effect of these oddities brings the church into the realm of the surrounding suburbia, formally and symbolically.

A second religious building, the redevelopment of St Patrick's Cathedral (1997-2003) in Parramatta, Sydney, is a larger but subtler work.²⁸ Aalto's influence is detectable in the building's interiors with blond timbers, white plaster walls and the careful control of natural light. Less overtly, the overall composition is ordered in a head-tail relationship with the pre-existing Neo-gothic cathedral that has affinities to Aalto's Enzo-Gutzeit building and its rapport with the Uspenski Cathedral. Giurgola also repeats the indistinct enclosure of his earlier Charnwood church by directly relating the main space to an adjoining courtyard in which he imagined children playing football, clouding the threshold between the sacred space and informal every day activities.

A final example of Giurgola's work in Australia, and the calculated indistinctness he developed, is a 'get away' house he built for himself and his daughter. The work is Giurgola's interpretation of an ideal villa in the Australian context, merging a Palladian plan with traditional Australian farmhouse forms and materials. Between earth/sky, short view/long view, closed spaces/open spaces, Giurgola's villa converses with the Australian landscape and simultaneously with the history of the villa type, aspiring to the achievements of Aalto and the historic narrative in the Villa Mairea.

Like Aalto on the periphery of Western urbanity, Giurgola found himself tackling a similar 'edge' condition in his adopted country. To meld contradictory forces, Giurgola looked to some of the strategies employed by Aalto. He borrowed some of Aalto's formal compositional strategies and use of materials, but more particularly Giurgola found that the principle of incompleteness was a good fit for the informality of the Australian context and landscape. Further, it was a transferable model that had the capacity to humanise buildings and connect them to their sites. Many of Giurgola's values have also been transferred to the next generation of architects that worked in his office during the Parliament era. Phillips/Pilkington Architects in South Australia are one such partnership that grew out of the Canberra office and are noted for their humanist approach and sensitivity to context.

Some other architects

The hybridisation of ideas from overseas has been claimed as a strength of Australian architecture.²⁹ Murcutt commented: 'One has to recognise Australians are the world's greatest copiers. Shift it about a bit, modify it, then call it their own'.³⁰ Similarly, Howard Raggatt has talked of 'Australian architects' cargo-cult mentality, meaning that Australian architects are accepting the importation of ideas from overseas as if they were free to pick them up off the back of a boat'.³¹

Murcutt places Aalto's influence at a deeper level. 'If you understand Aalto, then you start to ask questions about principles. And when you ask questions about principles, you can ask the same questions about one's own place. And then you start to find answers'.³² Much of this influence is about attitudes and values. Queensland architects Kerry and Lindsay Clare commented that 'For us the most significant lessons to be learnt from studying the work of Aalto, from visiting his works and home ground, are how he respected technology, acknowledged art as inseparable from life, how he was disciplined by landscape and climate and responded to culture and society'.³³ Sydney architect Ken Woolley 'wasn't so interested in Aalto's use of

detail—although you'll tend to see the use of brick, copper and wood—but I appreciated his ability to formally resolve what would normally be regarded as clashes. He was game to let different geometries come together and could make the resolution convincing at a time in architecture when everything was subordinated to the formal entity.³⁴

Rather than generalizing, in the remainder of this paper we shall comment briefly on the work of four prominent Australian practices: the Sydney-based practices of Glenn Murcutt and Candalepas Associates, and the Melbourne-based practices of Ashton Ragatt McDougall and John Wardle.

Glenn Murcutt

It is the influence of Mies van der Rohe that is most obvious in the architecture of Glenn Murcutt (1936 –), particularly in the pavilion houses he has designed in rural New South Wales since the 1970s. In all of Murcutt's work, though, the hard-edged formality of Mies is softened by the humanism of Aalto, along with other influences including the vernacular architecture of Australia and New Guinea seen as a child. 'In 1961, Murcutt stumbled across a book on Aalto and was knocked out by what he saw. More than 30 years later, his voice still rises to an excited pitch when he describes his reaction'.³⁵ In 1962 Murcutt worked temporarily in London and travelled in Europe, notably the Mediterranean and Nordic regions. In Finland, he was 'captivated by the thriving role of craft and the individualization of architect-designed details, particularly Aalto's'.³⁶ He was also 'lastingly impressed by the role of nature and the landscape in the creation of architectural order in all his buildings'.³⁷

According to the statement of the award of the Pritzker Prize in 2002, Glenn Murcutt

'acknowledges that his modernist inspiration has its roots in the work of Mies van der Rohe, but the Nordic tradition of Aalto, the Australian wool shed, and many other architects and designers such as Chareau, have been important to him as well. Add in the fact that all his designs are tempered by the land and climate of his native Australia, and you have the uniqueness that the jury has chosen to celebrate' – *Thomas J. Pritzker*



Figure 4: Arthur & Yvonne Boyd Education Centre, Riversdale (Murcutt Lewin Lark), 1996-99

The Arthur and Yvonne Boyd Education Centre (1996-69) (figure 4) in rural New South Wales was designed in association with Wendy Lewin and Reg Lark. Like many of Aalto's larger buildings, it is a 'head and tail' composition with a lofty multi-purpose hall at its head and an 'inhabited wall' of bedrooms as its tail. Details such as white pebbles alongside the walkway access to the bedrooms, slender fingers of

wood that make low canopies over their entrances, and leather binding around metal door handles in the hall, bring to mind Aalto's interest in expressing natural materials and making texture through the repetition of small elements. Large white vertical blades that break the early morning sun and bounce light into the bedrooms recall Aalto's fascination with natural light.

Candalepas Associates

Angelo Candalepas (1967 –) graduated in 1992 and started his own practice in 1994. Laura Harding notes his 'passionate interest in drawing as a means of understanding the work of personally influential Renaissance and Modern architects including Bramante, Aalto, Kahn and Gaudi'.³⁸ Of these, the influence of Aalto is most evident in Candalepas's designs. Harding points to All Saints Primary School, Sydney (2008) (figure 5 left), with its offset edges, light-filtering vertical timber screens and uncovered materials, as epitomising the practice's interest 'in crafting a buoyant public expression from modest materials and means'³⁹, an interest that also applies to much of Aalto's work, including his school at Inkeroinen (1938). In 2006 Candalepas visited many of Aalto's works, seeing his 'tireless and comprehensive attentiveness to details (screens, grilles, patterns for tiles)' that had been already an interest. 'The clarity, however, of Aalto's planning and the subtlety and laconic logic of forms previously considered as 'exuberant' ... (Seinäjoki and Säynätsalo Town Halls) was something of a surprise in his *in situ* readings of Aalto. This would show in later work where the detail and general composition were clearly affected by these observations.'⁴⁰

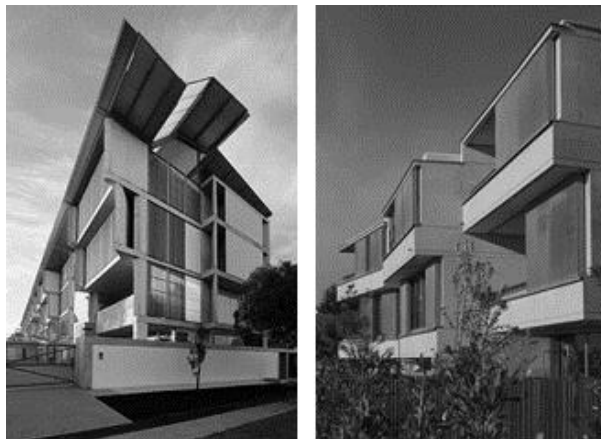

Figure 5: All Saints Primary School and Prince Street Apartments (Candalepas Associates). Photographer © Brett Boardman

An apartment project in Prince Street, Cronulla (2012) (figure 5 right), illustrates this influence. It has patterns of fan-shaped divergence (including the central corridor linking the front and back of the building), offset edges, more light-filtering vertical timber screens and what could be highly refined and abstracted versions of Aalto's handrails. Like Aalto's apartments in Hansa Viertel, Berlin (1957), these apartments have large 'outdoor room' balconies.

Ashton Raggatt MacDougall Architecture (ARM)

ARM began in Melbourne, Australia in 1986 as a collaboration between Steve Ashton, Howard Raggatt and Ian McDougall. Since then, the practice has produced designs and analytical projects in architecture, urbanism, landscape and interior design.



Figure 5: Extension to St Kilda Town Hall, Melbourne (Ashton Raggatt McDougall) 1994

Most of their work is not obviously Aalto-like, but for their post-modernist extension to St Kilda Town Hall (1994) both the rear elevation and an internal façade are based on Aalto's Finlandia Conference Centre and Concert Hall in Helsinki (1962-75). Aalto is not alone; other visual references in the project are to works by Philip Johnson and Richard Serra. Howard Raggatt commented:⁴¹

'Aalto is an architect's architect ... bold in that Nordic sense. Our work with him is part of our pursuit of the copy as a critical strategy. We're interested in testing him down here—not with an 'I'm in love with Aalto' attitude but with the idea of testing his work against the local. This was the rationale behind our Finlandia Hall incorporations at the St Kilda Town Hall. In doing so, we found out an interesting thing ... he's one of the few architects whose buildings have such iconic quality in both plan and elevation that our critical translations and quotations remain recognisable, and the erudite observer is allowed a very disconcerting *deja vu*. Few architects have constructed such power of recognition. We love him because he puts up a good fight.'

As in Finlandia, the concave curves of the exterior respond to trees in a park-like setting. Inside, a planar wall on the opposite side of a narrow arcade provides a 'reference' for the curves 'action', a typical Aalto strategy. Both compositions work well in their local contexts, irrespective of their Aalto origins.

John Wardle Architects

John Wardle 'has been right through Finland and seen much of Aalto's work'.⁴² He agrees there are many connections between his office's work and Aalto, citing particularly the use of brick. His work also features the Aalto devices of the overlaying of surfaces, repetition of elements, division of surfaces into linked sub-surfaces, 'offsets' in lines and planes, and more broadly inventiveness in the use of asymmetrical form (figure 7). Like Aalto, Wardle has designed light fittings, fixtures and furniture for his buildings. He refers to 'hybrid typology', the potential to take and adapt design forms from one project to another, often at very different scales. Like Aalto too, Wardle has his 'experimental house', a rural property on Brumby Island off the coast of Tasmania that he describes as 'a counterpoint to the Melbourne office' where he designed new 'shearers' quarters' for visitors.



Figure 7: Hawke Building, The University of South Australia, Adelaide (John Wardle) 2007

Despite these parallels, a Wardle design would never be mistaken for an Aalto design. He rarely copies the forms, with a notable exception in a current (2014) project. In Finland, Aalto's vases have inspired ice cube moulds, biscuit cutters, pot stands and napkin rings. Under the heading of 'inspiration from history', Wardle takes the plan form of Aalto's iconic Savoy Vase for a 28-storey apartment building on a prominent corner in Brisbane. It is only the basis, though; the developed design visualization looks Wardle, not Aalto.⁴³

Conclusion

In examining the influence of Alvar Aalto on Australian architecture, we find some obvious examples of 'borrowing' Aalto forms and adapting them to the Australian context. We find many more examples of the use of materials and compositional strategies that seem to mirror those of Aalto. The most important Aalto influence, though, is his humanism and focus on his buildings' users and occupants. Newell Platten remembered Sigfried Giedion's comment that 'Aalto was in love not with architecture but with life.' Australians like to think that they are 'in love with life', too. Aalto's works seems to resonate with many Australian architects' sensibilities. His buildings provide benchmarks for assessing their own success in making buildings that enhance the experience of living.

Acknowledgements

We thank Angelo Candalepas, Nigel Dickson, Albert Gillisen, Romaldo Giurgola, Harold Guida, Matthew Hardy, Newell Platten and John Wardle for assistance in conversations, comments or advice. The interpretations in this paper are our own. Photographs are by Antony Radford unless otherwise stated.

¹ In the 2011 census, 60% of Australia's population declared European ancestry.

² Philip Goad, 'Modernism', in Phillip Goad and Julie Willis (eds.), *Encyclopedia of Australian Architecture*, Cambridge University Press, Cambridge, 2012 (p.464).

³ Paul-Alan Johnson 'Modern functionalism and the radically ordinary: Towards a reinterpretation of architects educated in the 1930s and 1940s, *Fabrications: The Journal of the Society of Architectural Historians*, Australia and New

-
- Zealand, Volume 7, Issue 1, 1996: 113-128 (p120). Willem Marinus Dudok (1884 –1974) designed the brick Hilversum Town Hall (1931).
- ⁴ Newell Platten, in a conversation with Antony Radford, Adelaide, 2014.
- ⁵ Robert Woodward quoted in Paul Allan Johnson and Susan Lorne-Johnson, *Architects of the middle third: interviews with New South Wales architects who commenced practice in the 1930s and 1940s*, edited by Paul-Alan Johnson and Susan Lorne-Johnson, School of Architecture, University of New South Wales, 1992 (pp189-190). Woodward spent another year in Finland working for the firm of Viljo Revell.
- ⁶ Goad, 'Modernism', in Goad and Willis (eds.), *Encyclopedia of Australian Architecture*, p.467.
- ⁷ Glenn Murcutt quoted in Françoise Frominot, *Glenn Murcutt works and projects*, Thames and Hudson, London, 1995. Le Corbusier (1887-1965), Mies van der Rohe (1886-1969), and Frank Lloyd Wright (1867-1959) are Peter Blake's three *Master Builders* (Knopf, New York, 1960).
- ⁸ Albert Gillisen, in a conversation with Antony Radford, Adelaide, 2014. Gillisen was born in the Netherlands in 1921 and studied architecture after the war in Auckland, New Zealand before being appointed to Adelaide. His first visit to Finland was in 1961 ('I have lived and worked in 7 countries and travelled to over 70').
- ⁹ Davina Jackson, 'Aalto in Australia', *Architecture Australia*, 1998. Available on-line, <http://architectureau.com/articles/aalto-and-australia/> (accessed September 2014).
- ¹⁰ Phillip Goad and Julie Willis (eds.), *Encyclopedia of Australian Architecture*, Cambridge University Press, Cambridge, 2012.
- ¹¹ Colin St John Wilson, *The Other Tradition of Modern Architecture: The Uncompleted Project*, Academy Editions, London, 1995.
- ¹² Jackson, 'Aalto in Australia'. Platten commented that the UK journal *Architectural Review* was the only overseas journal regularly taken by the office of Dickson & Platten, so they would have seen this 'derivative' work as well as Aalto's own work published in this journal.
- ¹³ Robert Dickson quoted in Rachel Hurst, 'An unselfconscious architecture: the work of Robert Dickson', *Additions to architectural history: 19th Annual Conference of the Society of Architectural Historians Australia & New Zealand*, ed. By John Macarthur & Antony Moulis, Brisbane, 2002.
- ¹⁴ Matthew Hardy, personal communication, 2014. The 'urban morphologists' studied the component patterns of urban form and the process of its development.
- ¹⁵ Nigel Dickson, in a conversation with Antony Radford in Adelaide, 2014.
- ¹⁶ Rachel Hurst, 'Modest revolutionaries; the architecture of Dickson & Platten', *Limits: Proceedings from the 21st Annual Conference of the Society of Architectural Historians Australia & New Zealand*, ed. by Harriet Edquist and Hélène Frichot, Vol. 01 pp.233-238, Melbourne, 2004.
- ¹⁷ Sigfried Giedion, *Space, Time and Architecture: The Growth of a New Tradition*, Harvard University Press, Cambridge, Mass., first edition 1941.
- ¹⁸ Newell Platten, conversation with Antony Radford, Adelaide, 2014.

-
- ¹⁹ Dickson and Platten's 'Adelaide regional style' was paralleled by the so-called 'Sydney school', with a similar brick and timber architecture. Jennifer Taylor comments on how 'Aalto's fine buildings with their handsome brickwork and exposed timber trusses and the raw New Brutalism of England, suggested ... means to realise a richly toned and textured architecture within economic constraints'. Jennifer Taylor, *Australian Architecture Since 1960*, The Law Book Company, Sydney, 1986.
- ²⁰ Later, Matthew Hardy worked for fourteen years with Robert Dickson and played a significant role in the office's work.
- ²¹ See also Stephen Schrapel, Shifting 'CENTRE' in Australia: Romaldo Giurgola and Alvar Aalto, Proceedings of SAHANZ 2006, T. McMinn, D.J. Stephens, D.S. Basson, (eds.), 2006 pp.483-488.
- ²² Romaldo Giurgola, in conversation with Stephen Schrapel, 2002.
- ²³ David Bell, 'Unity and Aesthetics of Incompletion in Architecture', *Architectural Design: AD*, 1979, p175-182.
- ²⁴ Bell, as above.
- ²⁵ Romaldo Giurgola, 'Reflections on Buildings and the City: the realism of the partial vision', *Perspecta 9/10*, 1965, p107-130.
- ²⁶ Romaldo Giurgola, quoted in Stephen Frith, 'Past exchanges in the work of Romaldo Giurgola in Australia', Proceedings of *Interspaces: Art and Architectural Exchanges from East to West*, Melbourne 2001.
- ²⁷ Romaldo Giurgola, 'A Journey Through Architecture', Lecture presented at the University of Sydney in the Vice-Chancellor's Sesquicentenary Distinguished Lecture Series, 18 October 2001.
- ²⁸ Romaldo Giurgola, *Luminous Simplicity: The Architecture and Art of St. Patrick's Cathedral, Parramatta*, Macmillan Art Publishing, South Yarra, 2006.
- ²⁹ Bill MacMahon (ed), *The Architecture of East Australia*, Edition Axel Menges, Stuttgart / London, 2001.
- ³⁰ Glenn Murcutt quoted in Helen Greenwood, 'Alvar Aalto the finishing touch', *Architectural Review (Australia)* summer 1995/96 pp.99-101 (p.101).
- ³¹ Howard Raggatt quoted in Jackson, 'Aalto in Australia'.
- ³² Glenn Murcutt quoted in Greenwood, 'Alvar Aalto the finishing touch', p.101.
- ³³ Lindsay and Kerry Clare quoted in Jackson, 'Aalto in Australia'.
- ³⁴ Ken Woolley quoted in Jackson, 'Aalto in Australia'.
- ³⁵ Greenwood, 'Alvar Aalto the finishing touch', p.99.
- ³⁶ Françoise Frominot, *Glenn Murcutt works and projects*, Thames and Hudson, London, 1995, p.20.
- ³⁷ Frominot, *Glenn Murcutt works and projects*, pp.14,15. See also Philip Drew, *Touch this earth lightly: Glenn Murcutt in his own words*, Duffy and Snellgrove, Sydney, 1999, pp. 41-43.
- ³⁸ Laura Harding, 'Candalepas Associates', in Goad and Willis (eds.), *Encyclopedia of Australian Architecture*, p.133.
- ³⁹ Harding, 'Candalepas Associates', p.134.
- ⁴⁰ Candalepas Associates, personal communication, September 2014.
- ⁴¹ Howard Raggatt quoted in Jackson, 'Aalto in Australia'.
- ⁴² John Wardle, personal communication, 2014.

⁴³ Wardle, Lecture presented at the University of South Australia, Adelaide, 18 September 2014.